

**STIHL**<sup>®</sup>

# STIHL KM 94 R

Instruction Manual





## Contents

KombiSystem	2
Guide to Using this Manual	2
Safety Precautions and Working Techniques	3
Approved KombiTools	7
Mounting the Loop Handle	8
Fuel	9
Fueling	10
Starting / Stopping the Engine	11
Operating Instructions	13
Replacing the Air Filter	13
Adjusting the Carburetor	14
Spark Plug	14
Storing the Machine	15
Inspection and Maintenance by User	15
Inspections and Maintenance by Dealer	16
Maintenance and Care	17
Minimize Wear and Avoid Damage	19
Main Parts	20
Specifications	21
Maintenance and Repairs	22
Disposal	22
EC Declaration of Conformity	22

Dear Customer,

Thank you for choosing a quality engineered STIHL product.

It has been built using modern production techniques and comprehensive quality assurance. Every effort has been made to ensure your satisfaction and troublefree use of the product.

Please contact your dealer or our sales company if you have any queries concerning this product.

Your



Dr. Nikolas Stihl



KM 94 RC

This instruction manual is protected by copyright. All rights reserved, especially the rights to reproduce, translate and process with electronic systems.

## KombiSystem

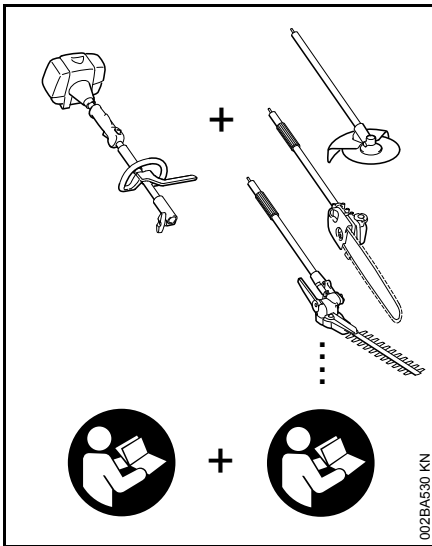

In the STIHL KombiSystem a number of different KombiEngines and KombiTools can be combined to produce a power tool. In this instruction manual the functional unit formed by the KombiEngine **and** KombiTool is referred to as the power tool.

Therefore, the separate instruction manuals for the KombiEngine and KombiTool should be used together for the power tool.

Always read and make sure you understand **both** instruction manuals before using your power tool for the first time and keep them in a safe place for future reference.

## Guide to Using this Manual

### Pictograms

The meanings of the pictograms attached to the machine are explained in this manual.

Depending on the model concerned, the following pictograms may be attached to your machine.

	Fuel tank; fuel mixture of gasoline and engine oil
	Operate decompression valve
	Manual fuel pump
	Operate manual fuel pump
	Tube of grease
	Intake air: Summer operation
	Intake air: Winter operation
	Handle heating

### Symbols in text

#### WARNING

Warning where there is a risk of an accident or personal injury or serious damage to property.

#### NOTICE

Caution where there is a risk of damaging the machine or its individual components.

### Engineering improvements

STIHL's philosophy is to continually improve all of its products. For this reason we may modify the design, engineering and appearance of our products periodically.

Therefore, some changes, modifications and improvements may not be covered in this manual.

## Safety Precautions and Working Techniques



Special safety precautions must be observed when working with a power tool.



Always read and make sure you understand both instruction manuals (KombiEngine and KombiTool) before using your power tool for the first time and keep them in a safe place for future reference. Non-observance of the safety precautions may result in serious or even fatal injury.

Observe all applicable local safety regulations, standards and ordinances.

If you have not used this type of power tool before: Have your dealer or other experienced user show you how to operate your machine or attend a special course in its operation.

Minors should never be allowed to use a power tool.

Keep bystanders, especially children, and animals away from the work area.

When the power tool is not in use, shut it off so that it does not endanger others. Secure it against unauthorized use.

The user is responsible for avoiding injury to third parties or damage to their property.

Lend or rent your power tool only to persons who are familiar with this model and its operation – do not lend or rent your power tool without the KombiEngine and KombiTool instruction manuals.

The use of noise emitting power tools may be restricted to certain times by national or local regulations.

To operate the power tool you must be rested, in good physical condition and mental health.

If you have any condition that might be aggravated by strenuous work, check with your doctor before operating a power tool.

Persons with pacemakers only: The ignition system of your power tool produces an electromagnetic field of a very low intensity. This field may interfere with some pacemakers. STIHL recommends that persons with pacemakers consult their physician and the pacemaker manufacturer to reduce any health risk.

Do not operate the power tool if you are under the influence of any substance (drugs, alcohol) which might impair vision, dexterity or judgment.

Use your power tool only for the applications described in the instruction manual of the KombiTool you are using.

Do not use your power tool for any other purpose because of the **increased risk of accidents**.

Do not operate the KombiEngine without a properly mounted KombiTool since this may result in damage to the machine.

Only use KombiTools and accessories that are explicitly approved for this power tool by STIHL or are technically identical. It is important that you read the chapter on "Approved KombiTools". If you have any questions in this respect, consult a servicing dealer. Use only high quality tools and accessories in order to avoid the risk of accidents and damage to the machine.

STIHL recommends the use of genuine STIHL tools and accessories. They are specifically designed to match the product and meet your performance requirements.

Never attempt to modify your power tool in any way since this may increase the risk of personal injury. STIHL excludes all liability for personal injury and damage to property caused while using unauthorized attachments.

Do not use a pressure washer to clean your power tool. The solid jet of water may damage parts of the power tool.

### Clothing and Equipment

Wear proper protective clothing and equipment.



Avoid clothing that could get caught on branches or brush or moving parts of the machine. Do not wear a scarf, necktie or jewelry. Tie up and confine long hair (e.g. with a hair net, cap, hard hat, etc.).

See also notes on "Clothing and Equipment" in the instruction manual of the KombiTool you are using.

## Transporting the Power Tool

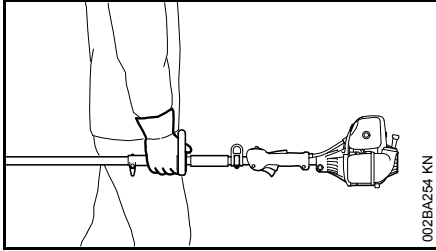

Always turn off the engine.

Transporting by vehicle: Properly secure your power tool to prevent turnover, fuel spillage and damage.

See also notes on "Transporting the Machine" in the instruction manual of the KombiTool you are using.

## Fueling



**Gasoline is an extremely flammable fuel.** Keep clear of naked flames. Do not spill any fuel – do not smoke.

Always shut off the engine before refueling.

Do not fuel a hot engine – **fuel may spill and cause a fire.**

Open the fuel cap carefully to allow any pressure build-up in the tank to release slowly and avoid fuel spillage.

Fuel your power tool only in well-ventilated areas. If you spill fuel, wipe the machine immediately – if fuel gets on your clothing, change immediately.



After fueling, tighten down the fuel tank cap as securely as possible.

This reduces the risk of unit vibrations causing the fuel cap to loosen or come off and spill quantities of fuel.

**To reduce the risk of serious or fatal burn injuries,** check for fuel leakage. If fuel leakage is found, do not start or run the engine until leak is fixed.

## Before Starting

Check that your power tool is properly assembled and in good condition – refer to appropriate chapters in the instruction manuals.

- Check the fuel system for leaks, paying special attention to visible parts such as the tank cap, hose connections and the manual fuel pump (on machines so equipped). If there are any leaks or damage, do not start the engine – **risk of fire.** Have your machine repaired by a servicing dealer before using it again.
- Use only an approved combination of cutting attachment, deflector, handle and harness. All parts must be assembled properly and securely.
- The stop switch must move freely.

- Smooth action of choke knob, throttle trigger lockout and throttle trigger – the throttle trigger must return automatically to the idle position. The choke knob must spring back from the **I** position to the run position **I** when the throttle trigger lockout and throttle trigger are squeezed.
- Check that the spark plug boot is secure – a loose boot may cause arcing that could ignite combustible fumes **and cause a fire.**
- Never attempt to modify the controls or safety devices in any way.
- Keep the handles dry and clean – free from oil and dirt – for safe control of the power tool.
- Adjust harness and handle to suit your height and reach.

**To reduce the risk of accidents,** do not operate your power tool if it is damaged or not properly assembled.

If you use a shoulder strap or full harness: Practice removing and putting down the machine as you would in an emergency. To avoid damage, do not throw the machine to the ground when practicing.

See also notes on "Before Starting" in the instruction manual of the KombiTool you are using.

## Start the engine.

Start the engine at least 3 meters from the fueling spot, outdoors only.

Place the unit on firm ground in an open area. Make sure you have good balance and secure footing. Hold the unit

securely. The attachment must be clear of the ground and all other obstructions because it may begin to run when the engine starts.

**To reduce the risk of injury**, avoid contact with the attachment.

Do not drop start the power tool – start the engine as described in the instruction manual. Note that the attachment continues to run for a short period after you let go of the throttle trigger – flywheel effect.

Check idle speed setting: The attachment must be stationary when the engine is idling with the throttle trigger released.

**To reduce the risk of fire**, keep hot exhaust gases and hot muffler away from easily combustible materials (e.g. wood chips, bark, dry grass, fuel).

See also notes on "Starting / Stopping the Engine" in the instruction manual of the KombiTool you are using.

### Holding and Controlling the Power Tool

Always hold the power tool firmly with both hands on the handles.

Make sure you always have good balance and secure footing.

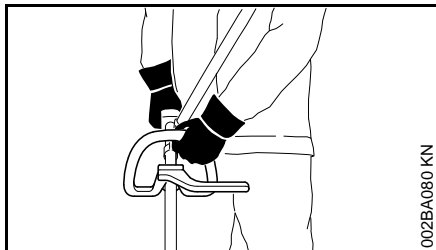

Left hand on loop handle, right hand on control handle, even if you are left-handed.

On the HT-KM KombiTool, use the handle hose as the left handle.

### During Operation

In the event of impending danger or in an emergency, switch off the engine immediately – move the stop switch in the direction of 0.

The correct engine idle speed is important to ensure that the attachment stops moving when you let go of the throttle trigger.

Check and correct the idle speed setting regularly. If the attachment continues to move when the engine is idling, have your dealer check the machine and make proper adjustments or repairs. STIHL recommends an authorized STIHL servicing dealer.

Be particularly alert and cautious when wearing hearing protection because your ability to hear warnings (shouts, alarms, etc.) is restricted.

**To reduce the risk of accidents**, take a break in good time to avoid tiredness or exhaustion.

Work calmly and carefully – in daylight conditions and only when visibility is good. Stay alert so as not to endanger others.

Use your power tool only for those applications described in the KombiTool instruction manual.



Your power tool produces toxic exhaust fumes as soon as the engine is running. These fumes may be colorless and odorless and contain unburned hydrocarbons and benzol. Never operate the power tool in enclosed or poorly ventilated locations.

**To reduce the risk of serious or fatal injury from breathing toxic fumes**, ensure proper ventilation when working in trenches, hollows or other confined locations.

**To reduce the risk of accidents**, stop work immediately in the event of nausea, headache, visual disturbances (e.g. reduced field of vision), problems with hearing, dizziness, deterioration in ability to concentrate. Apart from other possibilities, these symptoms may be caused by an excessively high concentration of exhaust gases in the work area.

Operate your power tool so that it produces a minimum of noise and emissions – do not run the engine unnecessarily, accelerate the engine only when working.

## English

**To reduce the risk of fire, do not smoke** while operating or standing near your power tool. Note that combustible fuel vapor may escape from the fuel system.

The dusts, vapor and smoke produced during operation may be dangerous to health. Wear a suitable respirator in very dusty or smoky conditions.

If your power tool is subjected to unusually high loads for which it was not designed (e.g. heavy impact or a fall), always check that it is in good condition before continuing work – see also "Before Starting".

Check the fuel system in particular for leaks and make sure the safety devices are working properly. Do not continue operating your power tool if it is damaged. In case of doubt, consult your servicing dealer.

Before leaving the power tool unattended: Shut off the engine.

**To reduce the risk of injury**, always shut off the engine before changing the KombiTool or attachment.

### Vibrations

Prolonged use of the power tool may result in vibration-induced circulation problems in the hands (whitefinger disease).

No general recommendation can be given for the length of usage because it depends on several factors.

The period of usage is prolonged by:

- Hand protection (wearing warm gloves)
- Work breaks

The period of usage is shortened by:

- Any personal tendency to suffer from poor circulation (symptoms: frequently cold fingers, tingling sensations).
- Low outside temperatures.
- The force with which the handles are held (a tight grip restricts circulation).

Continual and regular users should monitor closely the condition of their hands and fingers. If any of the above symptoms appear (e.g. tingling sensation in fingers), seek medical advice.

### Maintenance and Repairs

Service the machine regularly. Do not attempt any maintenance or repair work not described in the instruction manual. Have all other work performed by a servicing dealer.

STIHL recommends that you have servicing and repair work carried out exclusively by an authorized STIHL servicing dealer. STIHL dealers are regularly given the opportunity to attend training courses and are supplied with the necessary technical information.

Only use high-quality replacement parts in order to avoid the risk of accidents and damage to the machine. If you have any questions in this respect, consult a servicing dealer.

STIHL recommends the use of original STIHL replacement parts. They are specifically designed to match your model and meet your performance requirements.

To reduce the risk of injury from unintentional engine startup, **always shut off the engine and disconnect the spark plug boot** before performing any repairs, maintenance or cleaning work. – Exception: Carburetor and idle speed adjustments.

Do not turn the engine over on the starter with the spark plug boot or spark plug removed since there is otherwise a **risk of fire** from uncontained sparking.

To reduce the **risk of fire**, do not service or store your machine near open flames.

Check the fuel filler cap for leaks at regular intervals.

Use only a spark plug of the type approved by STIHL and make sure it is in good condition – see "Specifications".

Inspect the ignition lead (insulation in good condition, secure connection).

Check the condition of the muffler.

To reduce the **risk of fire and damage to hearing**, do not operate your machine if the muffler is damaged or missing. –

Do not touch a hot muffler since **burn injury** will result.

Vibration behavior is influenced by the condition of the AV elements – check the AV elements at regular intervals.



## Approved KombiTools

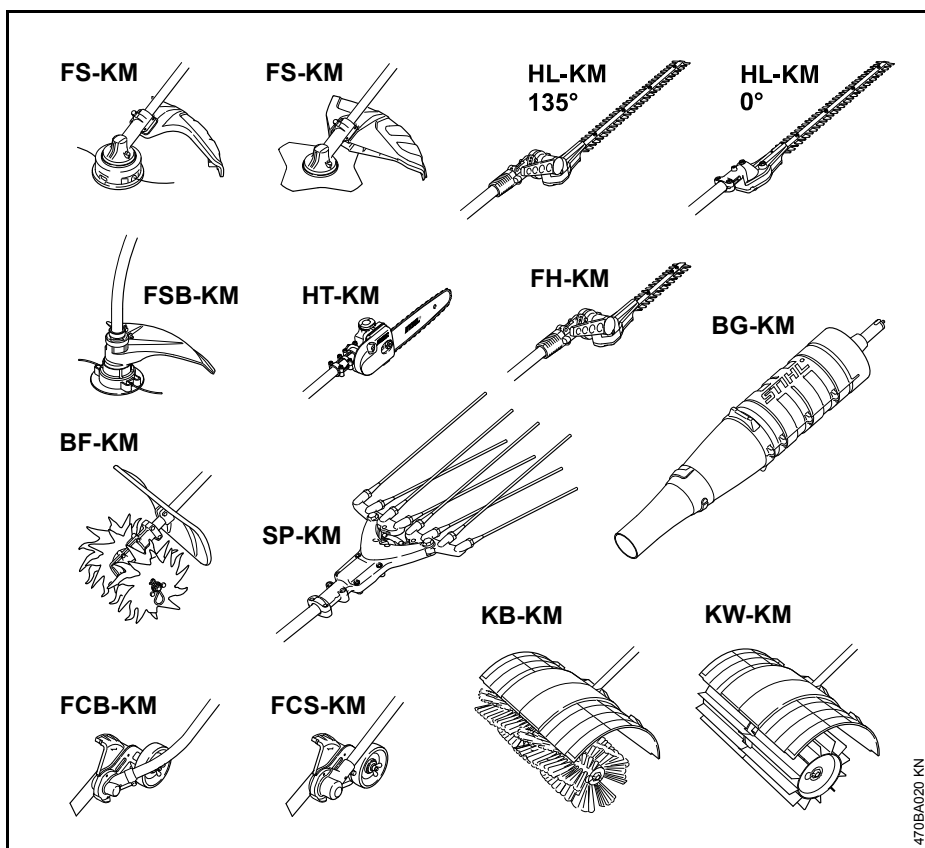

The following STIHL KombiTools may be mounted on the KombiEngine:

KombiTool	Application
FS-KM	Trimmer with mowing head
FS-KM <sup>1)</sup>	Trimmer with grass cutting blade
FSB-KM	Trimmer with mowing head
HL-KM 135°	Hedge trimmer, adjustable
HL-KM 0°	Long reach hedge trimmer
FH-KM 135°	Power scythe
BG-KM	Blower
HT-KM	Pole pruner
BF-KM	Pick tines
FCB-KM	Edger
FCS-KM	Edger
SP-KM	Special harvester
KB-KM	Bristle brush
KW-KM	PowerSweep

<sup>1)</sup> the barrier bar on the loop handle supplied with the machine must be used – see also "Mounting the Loop Handle"

470BA020 KN

## Mounting the Loop Handle

A barrier bar is supplied with the machine. Fit the barrier bar on the loop handle.

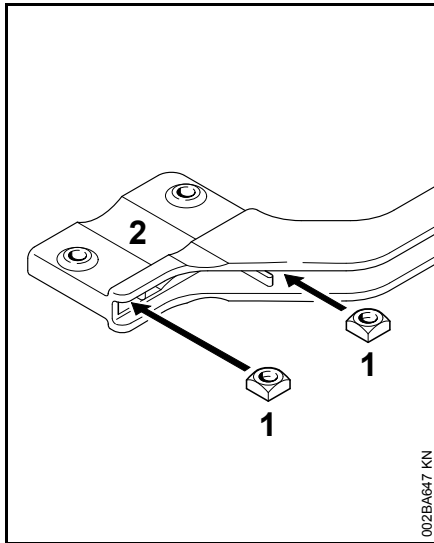

- Fit the square nuts (1) in the barrier bar (2); the holes must line up.

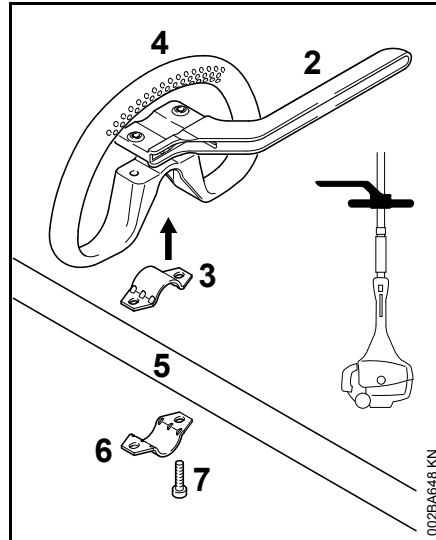

- Place the clamp (3) in the loop handle (4) and position them both against the drive tube (5).
- Position the clamp (6) against the drive tube.
- Place the barrier bar (2) in position as shown.
- Line up the holes.
- Insert the screws (7) in the holes and screw them into the barrier bar (2) as far as stop.
- Go to "Adjusting and Securing the Loop Handle".

## Adjusting and Securing the Loop Handle

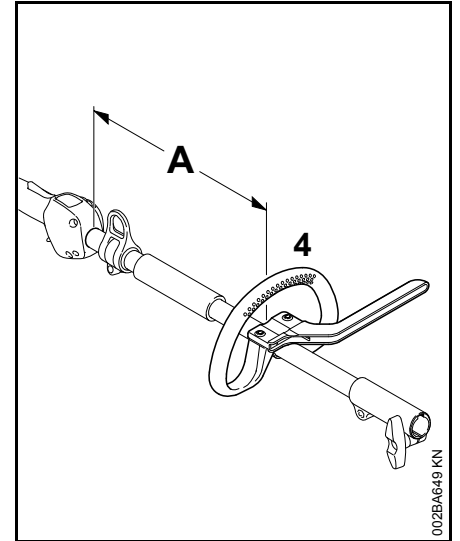

The loop handle can be adjusted to suit the height and reach of the operator and the application by changing distance (A).

Recommendation: distance (A): about 22 cm (8.7 in)

- Slide the handle to the required position.
- Line up the loop handle (4).
- Tighten down the screws until the loop handle can no longer be rotated on the drive tube. If no barrier bar is fitted – lock the nuts if necessary.

**Leave the barrier bar permanently mounted to the loop handle.**

## Fuel

Your engine requires a mixture of gasoline and engine oil.

### WARNING

For health reasons, avoid direct skin contact with gasoline and avoid inhaling gasoline vapor.

### STIHL MotoMix

STIHL recommends the use of STIHL MotoMix. This ready-to-use fuel mix contains no benzol or lead, has a high octane rating and ensures that you always use the right mix ratio.

STIHL MotoMix uses STIHL HP Ultra two-stroke engine oil for an extra long engine life.

MotoMix is not available in all markets.

### Mixing Fuel

### NOTICE

Unsuitable fuels or lubricants or mix ratios other than those specified may result in serious damage to the engine. Poor quality gasoline or engine oil may damage the engine, sealing rings, hoses and the fuel tank.

### Gasoline

Use only high-quality **brand-name** gasoline with a minimum octane rating of 90 – leaded or unleaded.

If your machine is equipped with a catalytic converter, you must use unleaded gasoline.

### NOTICE

A few tankfuls of leaded gasoline will greatly reduce the efficiency of the catalytic converter.

Gasoline with an ethanol content of more than 10% can cause running problems in engines with a manually adjustable carburetor and should not be used in such engines.

Engines equipped with M-Tronic deliver full power when run on gasoline with an ethanol content of up to 25% (E25).

### Engine oil

Use only high-quality two-stroke engine oil – preferably **STIHL HP, HP Super or HP Ultra, which are specially formulated for use in STIHL engines. HP Ultra guarantees high performance and a long engine life.**

These engine oils are not available in all markets.

Use only **STIHL 50:1 two-stroke engine oil** for the fuel mix in models with a catalytic converter.

### Mix Ratio

STIHL 50:1 two-stroke engine oil: 50 parts gasoline to 1 part oil

### Examples

Gasoline Liters	STIHL engine oil 50:1	
	Liters	(ml)
1	0.02	(20)
5	0.10	(100)
10	0.20	(200)
15	0.30	(300)
20	0.40	(400)
25	0.50	(500)

- Use a canister approved for storing fuel. Pour oil into canister first, then add gasoline and mix thoroughly.

### Storing Fuel

Store fuel only in approved safety-type fuel canisters in a dry, cool and safe location protected from light and the sun.

**Fuel mix ages** – only mix sufficient fuel for a few weeks work. Do not store fuel mix for longer than 30 days. Exposure to light, the sun, low or high temperatures can quickly make the fuel mix unusable.

STIHL MotoMix may be stored for up to 2 years without any problems.

- Thoroughly shake the mixture in the canister before fueling your machine.

### WARNING

Pressure may build up in the canister – open it carefully.

- Clean the fuel tank and canister from time to time.

English

Dispose of remaining fuel and cleaning fluid properly in accordance with local regulations and environmental requirements.

## Fueling

### Fuel filler cap

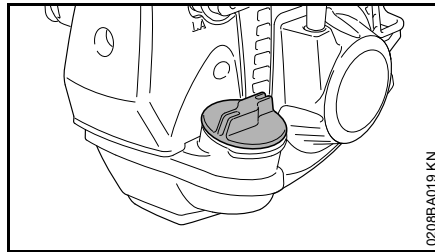

### WARNING

When fueling on a slope, always position the machine with the filler cap facing uphill.

- Place the machine on level ground so that the filler cap is facing up.
- Before fueling, clean the filler cap and the area around it to ensure that no dirt falls into the tank.

### Open the tank cap.

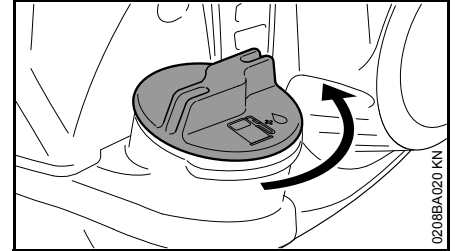

- Turn the cap counterclockwise until it can be removed from the tank opening.
- Remove the cap.

### Filling up with fuel

Take care not to spill fuel while fueling and do not overfill the tank.

STIHL recommends you use the STIHL filler nozzle for fuel (special accessory).

- Fill up with fuel.

### Close the tank cap.

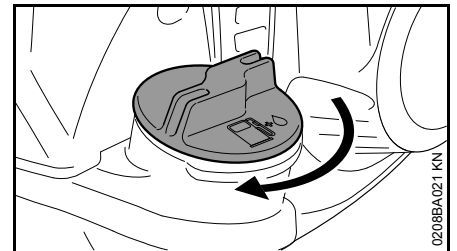

- Place the cap in the opening.
- Turn the cap clockwise as far as stop and tighten it down as firmly as possible by hand.

## Starting / Stopping the Engine

### Controls

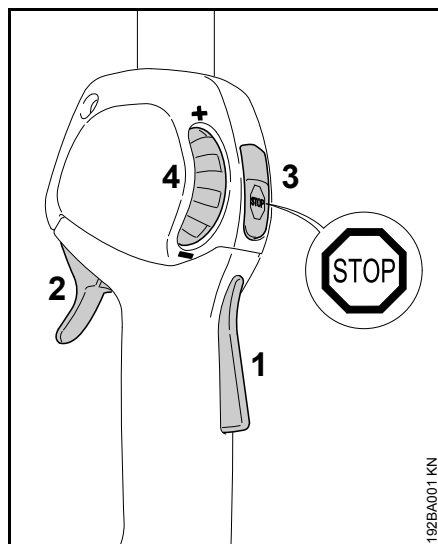

- 1 Throttle trigger lockout
- 2 Throttle trigger
- 3 Stop switch with **Run** and **Stop** positions. Press the stop switch (⊞) to switch off the ignition – see "Function of stop switch and ignition system".
- 4 Throttle set wheel – limits travel of throttle trigger – see "Function of throttle set wheel".

### Function of stop switch and ignition system

The ignition is switched off and the engine stopped when the stop switch is pressed. The stop switch returns automatically to the **Run** position when it

is released: The ignition is switched on again after the engine stops – the engine is then ready to start.

### Function of throttle set wheel

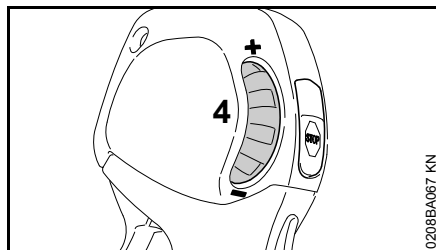

The throttle set wheel (4) enables the travel of the throttle trigger to be preset anywhere between idle and full throttle.

- Turn throttle set wheel (4) in direction of - to reduce throttle trigger travel and maximum engine speed.
- Turn throttle set wheel (4) in direction of + to increase throttle trigger travel and maximum engine speed.
- It is possible to override the preset stop and open the throttle wide by pulling the throttle trigger firmly – the preset stop remains unaffected. The original setting is restored when the throttle trigger is released.

### Starting the Engine

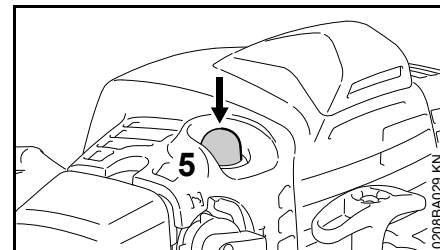

- Press the manual fuel pump bulb (5) at least five times – even if the bulb is filled with fuel.
- Turn throttle set wheel in direction of + as far as stop.

### Cold engine (cold start)

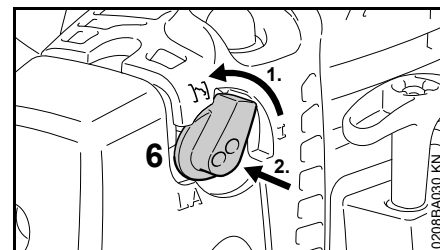

- Turn choke knob (6) and then push it in at **I**

Also use this setting if the engine has been running but is still cold.

### Hot engine (hot start)

- Choke knob (6) remains in **I** position.

## Cranking

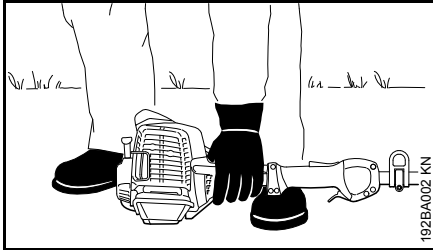

- Place the power tool on the ground so that it rests on the machine support:
- If fitted: Remove the transport guard from the cutting attachment.

**To reduce the risk of accidents**, check that the working tool is not touching the ground or any other obstacles – see also "Starting / Stopping the Engine" in the KombiTool instruction manual.

- Make sure you have a firm footing, either standing, stooping or kneeling.
- Hold the unit **firmly** on the ground with your left hand and press down – do not touch the throttle trigger, lockout lever or stop switch.



### NOTICE

Do not stand or kneel on the drive tube.

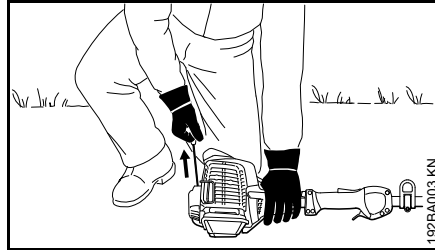

- Hold the starter grip with your right hand.
- Pull the starter grip slowly and steadily.



### NOTICE

Do not pull out the starter rope all the way – **it might otherwise break**.

- Do not let the starter grip snap back. Guide it slowly back into the housing so that the starter rope can rewind properly.
- Continue cranking until engine runs.

### As soon as the engine runs

#### At temperatures below +10 °C

Warm up the engine for at least 10 seconds in position **I**.

#### At temperatures above +10 °C

Warm up the engine for at least 5 seconds in position **I**.

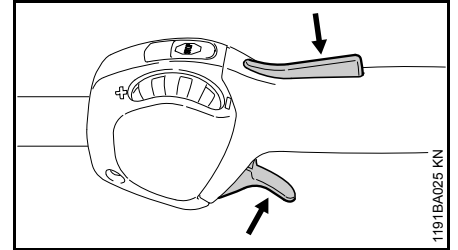

- Depress throttle trigger lockout and pull the throttle trigger – the choke knob moves to the Run **I** position.

Warm up a **cold engine** at varying speeds.



### WARNING

Make sure the carburetor is correctly adjusted. The working tool must not rotate when the engine is idling.

Your machine is now ready for operation.

### Stopping the Engine

- Depress the momentary contact stop switch – the engine stops – release the stop switch – it springs back to the run position.

### Other Hints on Starting

#### Engine stalls in cold start position **I**.

- Depress throttle trigger lockout and pull the throttle trigger – the choke knob moves to the Run **I** position.
- Continue cranking in position **I** until the engine runs.

**Running engine stalls in cold start position  $\bar{I}$  or under acceleration.**

- Continue cranking in position **I** until the engine runs.

**If the engine does not start**

- Check that all settings are correct.
- Check that there is fuel in the tank and refuel if necessary.
- Check that the spark plug boot is properly connected.
- Repeat the starting procedure.

**Fuel tank run until completely dry**

- After refueling, press the manual fuel pump bulb at least five times – even if the bulb is filled with fuel.
- Set the choke knob according to engine temperature.
- Now start the engine.

## Operating Instructions

### During break-in period

A factory-new machine should not be run at high revs (full throttle off load) for the first three tank fillings. This avoids unnecessary high loads during the break-in period. As all moving parts have to bed in during the break-in period, the frictional resistances in the engine are greater during this period. The engine develops its maximum power after about 5 to 15 tank fillings.

### During Operation

After a long period of full throttle operation, allow the engine to run for a short while at idle speed so that engine heat can be dissipated by the flow of cooling air. This protects engine-mounted components (ignition, carburetor) from thermal overload.

### After Finishing Work

Storing for a short period: Wait for the engine to cool down. Empty the fuel tank and keep the machine in a dry place, well away from sources of ignition, until you need it again. For longer out-of-service periods – see "Storing the Machine".

## Replacing the Air Filter

Do not remove the filter cover or replace the air filter as long as there is no noticeable loss of power.

### If there is a noticeable loss of engine power

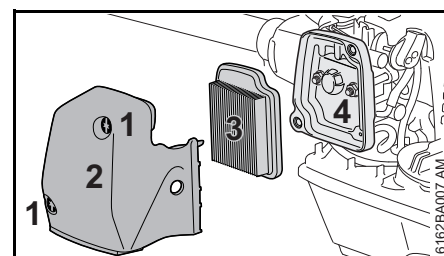

- Turn the choke knob to  $\bar{I}$ .
- Take out the screws (1).
- Remove the filter cover (2).
- Clean away loose dirt from around the filter.
- Remove the filter element (3).
- Replace dirty or damaged filters.
- Replace any damaged parts.
- Fit the new air filter in the filter housing (4).
- Fit the filter cover.
- Fit the screws and tighten them down firmly.

## Adjusting the Carburetor

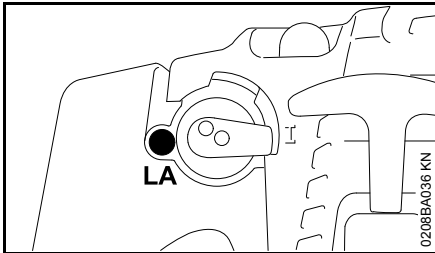

The carburetor has been set at the factory to provide an optimum fuel-air mixture under most operating conditions.

### Adjusting idle speed

#### Engine stops while idling

- Turn the idle speed screw (LA) slowly clockwise until the engine runs smoothly – the attachment must not run.

#### Attachment runs when engine is idling

- Turn the idle speed screw (LA) slowly counterclockwise until the attachment stops running.

#### WARNING

If the attachment continues to run when the engine is idling, have your machine checked and repaired by your servicing dealer.

## Spark Plug

- If the engine is down on power, difficult to start or runs poorly at idle speed, first check the spark plug.
- Fit a new spark plug after about 100 operating hours – or sooner if the electrodes are badly eroded. Install only suppressed spark plugs of the type approved by STIHL – see "Specifications".

### Removing the spark plug

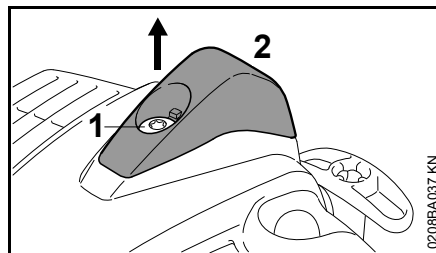

- Turn screw (1) in cap (2) until cap can be removed
- Lay down cap

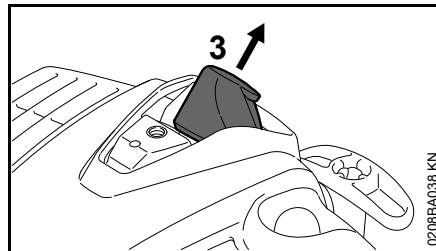

- Unplug spark plug boot (3)
- Unscrew spark plug

## Checking the Spark Plug

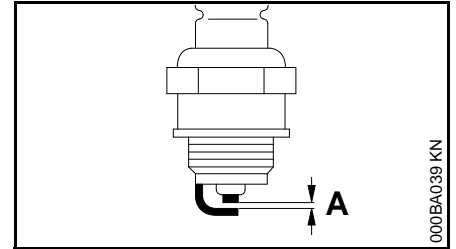

- Clean dirty spark plug.
- Check electrode gap (A) and readjust if necessary – see "Specifications".
- Rectify the problems which have caused fouling of the spark plug.

Possible causes are:

- Too much oil in fuel mix.
- Dirty air filter.
- Unfavorable running conditions.

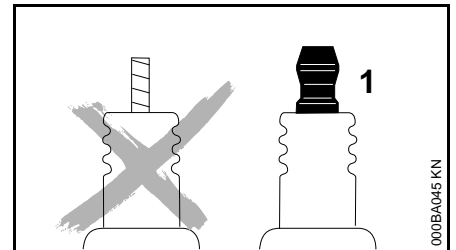

#### WARNING

Arcing may occur if the adapter nut (1) is loose or missing. Working in an easily combustible or explosive atmosphere may cause a fire or an explosion. This can result result in serious injuries or damage to property.



- Use resistor type spark plugs with a properly tightened adapter nut.

### Installing the Spark Plug

- Fit the spark plug and tighten it down firmly.
- Press the boot **firmly** onto the spark plug.

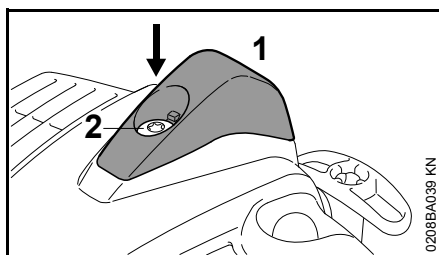

- Fit the cap (1), insert the screw (2) and tighten it down firmly.

## Storing the Machine

For periods of 3 months or longer

- Drain and clean the fuel tank in a well ventilated area.
- Dispose of fuel properly in accordance with local environmental requirements.
- Run the engine until the carburetor is dry – this helps prevent the carburetor diaphragms sticking together.
- Thoroughly clean the machine – pay special attention to the air filter.
- Remove, clean and check the attachment. Coat metal parts with corrosion inhibiting oil.
- Store the machine in a dry and secure location. Keep out of the reach of children and other unauthorized persons.

## Inspection and Maintenance by User

### Throttle Cable

#### Checking adjustment of throttle cable

Error: Engine speed increases when **only** the throttle trigger is depressed.

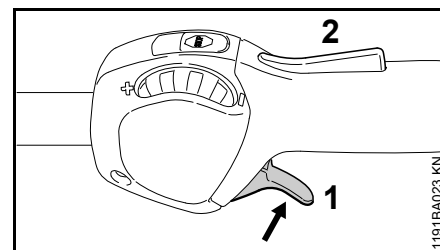

- Start the engine.
- Depress the throttle trigger (1) – **do not** press down the throttle trigger lockout (2).

If the engine speed increases or if the cutting attachment rotates, the throttle cable has to be adjusted.

- Shut off the engine.
- Have throttle cable adjusted by your dealer. STIHL recommends an authorized STIHL servicing dealer.

## Inspections and Maintenance by Dealer

### Maintenance Work

STIHL recommends that you have servicing and repair work carried out exclusively by an authorized STIHL servicing dealer.

### Fuel Pickup Body in Tank

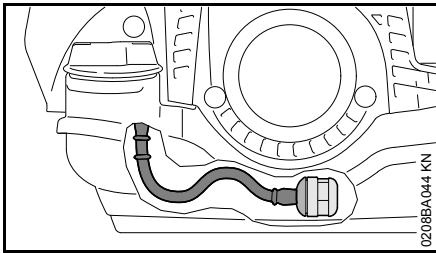

- Check the pickup body in the fuel tank every year and have it replaced if necessary.

The pickup body should be positioned in the area of the tank shown in the illustration.

### Antivibration Element

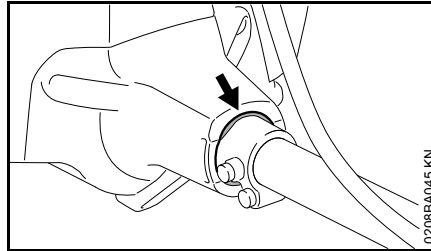

A vibration-absorbing rubber element is installed between the powerhead and the drive tube. Have it checked if there are signs of wear or a noticeable increase in vibration levels.

## Maintenance and Care

The following intervals apply to normal operating conditions only. If your daily working time is longer or operating conditions are difficult (very dusty work area, etc.), shorten the specified intervals accordingly.		before starting work	after finishing work or daily	after each refueling stop	weekly	monthly	every 12 months	if problem	if damaged	as required
Complete machine	Visual inspection (condition, leaks)	X		X						
	Clean		X							
	Replace any damaged parts	X								
Control handle	Check operation	X		X						
Air filter	Visual Inspection					X		X		
	Clean filter housing									X
	Replace felt filter <sup>1)</sup>								X	X
Fuel tank	Clean					X		X		X
Manual fuel pump (if fitted)	Check	X								
	Have repaired by servicing dealer <sup>2)</sup>								X	
Pickup body in fuel tank	Have checked by servicing dealer <sup>2)</sup>							X		
	Have replaced by servicing dealer <sup>2)</sup>						X		X	X
Carburetor	Check idle adjustment – the working/cutting attachment must not run	X		X						
	Adjust idle speed									X
Spark plug	Adjust electrode gap							X		
	Replace after every 100 operating hours									
Cooling inlets	Visual Inspection		X							
	Clean									X
Cylinder fins	Have cleaned by servicing dealer <sup>2)</sup>						X			
Exhaust port	Have decoked by servicing dealer <sup>2)</sup> after first 139 hours of operation, then every 150 hours of operation									X

English

The following intervals apply to normal operating conditions only. If your daily working time is longer or operating conditions are difficult (very dusty work area, etc.), shorten the specified intervals accordingly.		before starting work	after finishing work or daily	after each refueling stop	weekly	monthly	every 12 months	if problem	if damaged	as required
All accessible screws and nuts (not adjusting screws)	Retighten									X
Anti-vibration elements	Visual inspection <sup>3)</sup>	X						X		X
	Have replaced by servicing dealer <sup>2)</sup>								X	
Safety labels	Replace								X	

- 1) Only if there is a noticeable loss of engine power
- 2) STIHL recommends an authorized STIHL servicing dealer.
- 3) see chapter "Inspections and Maintenance by Dealer", section "Antivibration Elements"

## Minimize Wear and Avoid Damage

Observing the instructions in this manual helps reduce the risk of unnecessary wear and damage to the power tool.

The power tool must be operated, maintained and stored with the due care and attention described in this owner's manual.

The user is responsible for all damage caused by non-observance of the safety precautions, operating and maintenance instructions in this manual. This includes in particular:

- Alterations or modifications to the product not approved by STIHL.
- Using tools or accessories which are neither approved or suitable for the product or are of a poor quality.
- Using the product for purposes for which it was not designed.
- Using the product for sports or competitive events.
- Consequential damage caused by continuing to use the product with defective components.

### Maintenance Work

All the operations described in the "Maintenance Chart" must be performed on a regular basis. If these maintenance operations cannot be performed by the owner, they should be performed by a servicing dealer.

STIHL recommends that you have servicing and repair work carried out exclusively by an authorized STIHL

servicing dealer. STIHL dealers are regularly given the opportunity to attend training courses and are supplied with the necessary technical information.

If these maintenance operations are not carried out as specified, the user assumes responsibility for any damage that may occur. Among other parts, this includes:

- Damage to the engine due to neglect or deficient maintenance (e.g. air and fuel filters), incorrect carburetor adjustment or inadequate cleaning of cooling air inlets (intake ports, cylinder fins).
- Corrosion and other consequential damage resulting from improper storage.
- Damage to the machine resulting from the use of poor quality replacement parts.

### Parts Subject to Wear and Tear

Some parts of the power tool are subject to normal wear and tear even during regular operation in accordance with instructions and, depending on the type and duration of use, have to be replaced in good time. Among other parts, this includes:

- Clutch
- Filters (air, fuel)
- Rewind starter
- Spark plug

## Main Parts

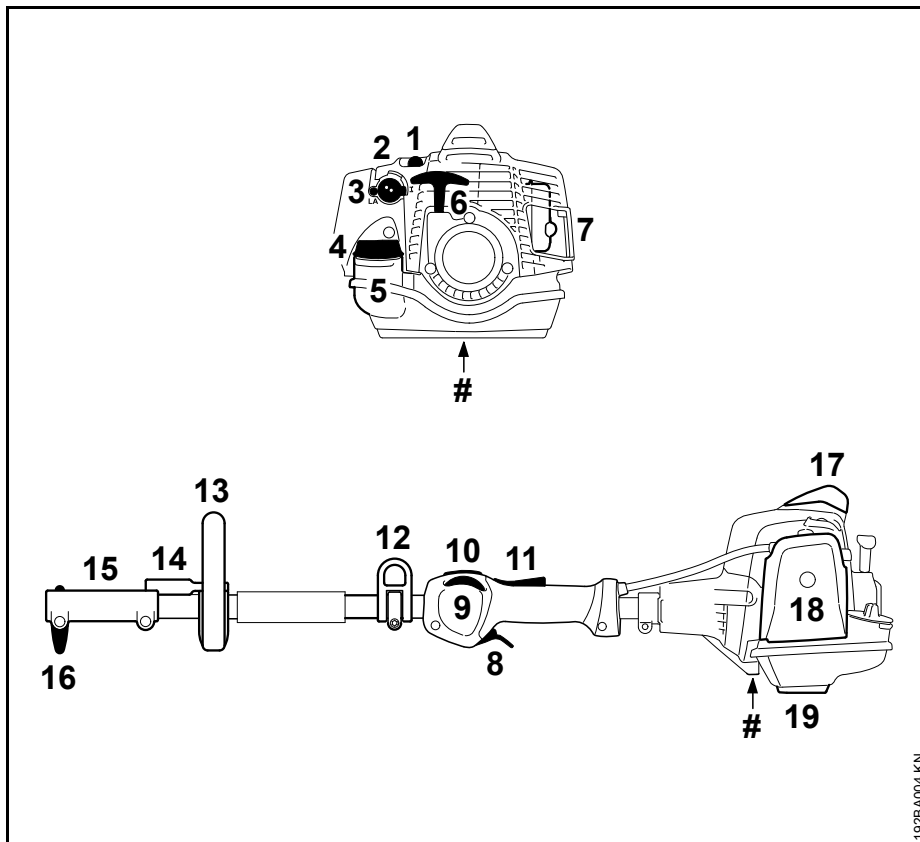

- 1 Manual fuel pump
- 2 Choke knob
- 3 Carburetor adjusting screw
- 4 Tank cap
- 5 Fuel tank
- 6 Starter grip
- 7 Muffler
- 8 Throttle trigger
- 9 Adjusting wheel
- 10 Stop switch
- 11 Throttle trigger lockout
- 12 Carrying ring
- 13 Loop handle
- 14 Barrier bar
- 15 Coupling sleeve
- 16 Wing screw
- 17 Spark plug boot with cap
- 18 Air filter cover
- 19 Machine support
- # Serial number

## Specifications

### Engine

Single cylinder two-stroke engine

Displacement:	24.1 cc
Bore:	35 mm
Stroke:	25 mm
Engine power to ISO 8893:	0.9 kW (1.2 bhp) at 8,500 rpm
Idle speed:	2,800 rpm
Cut-off speed (rated):	9,800 rpm
Max. torque / engine speed:	1.3 Nm at 5,000 rpm

### Ignition System

Electronic magneto ignition

Spark plug (resistor type):	NGK CMR 6 H
Electrode gap:	0.5 mm

### Fuel System

All position rotary valve carburetor with integral fuel pump

Fuel tank capacity: 540 cc (0.54 l)

### Weight

dry, without KombiTool  
KM 94 RC-E: 4.0 kg

### Features

- C Convenience features
- R Loop handle
- E ErgoStart

### Noise and Vibration Data

#### with KombiTool

For version see "Approved KombiTools".

For further details on compliance with Vibration Directive 2002/44/EC see [www.stihl.com/vib](http://www.stihl.com/vib).

Noise and vibration data measurements include idling and rated maximum speed in the following ratios.

FCB-KM, FCS-KM, FH-KM, FS-KM, FSB-KM and HT-KM	1 to 1
HL-KM	1 to 4
BF-KM, KB-KM, KW-KM, BG-KM and SP-KM	1 to 6

#### Sound pressure level $L_{peq}$ to ISO 10517, ISO 11201, ISO 11789, ISO 22868

91 dB(A) ... 95 dB(A)

#### Sound power level $L_w$ to ISO 22868

106 dB(A) ... 109 dB(A)

#### Sound power level $L_w$ to ISO 10517, ISO 11201, ISO 11789

103 dB(A) ... 105 dB(A)

#### Vibration measurement $a_{hv,eq}$ to ISO 22867

##### Handle, left

3.8 m/s<sup>2</sup> ... 7.2 m/s<sup>2</sup>

##### Handle, right

3.1 m/s<sup>2</sup> ... 7.2 m/s<sup>2</sup>

The K-factor in accordance with Directive 2006/42/EC is 2.5 dB(A) for the sound pressure level and sound power level; the K-factor in accordance with Directive 2006/42/EC is 2.0 m/s<sup>2</sup> for the vibration measurement.

### REACH

REACH is an EC regulation and stands for the Registration, Evaluation, Authorisation and Restriction of Chemical substances.

For information on compliance with the REACH regulation (EC) No. 1907/2006 see [www.stihl.com/reach](http://www.stihl.com/reach).

## Maintenance and Repairs

Users of this machine may only carry out the maintenance and service work described in this user manual. All other repairs must be carried out by a servicing dealer.

STIHL recommends that you have servicing and repair work carried out exclusively by an authorized STIHL servicing dealer. STIHL dealers are regularly given the opportunity to attend training courses and are supplied with the necessary technical information.

When repairing the machine, only use replacement parts which have been approved by STIHL for this power tool or are technically identical. Only use high-quality replacement parts in order to avoid the risk of accidents and damage to the machine.

STIHL recommends the use of original STIHL replacement parts.

Original STIHL parts can be identified by the STIHL part number, the **STIHL** logo and the STIHL parts symbol  (the symbol may appear alone on small parts).

## Disposal

Observe all country-specific waste disposal rules and regulations.

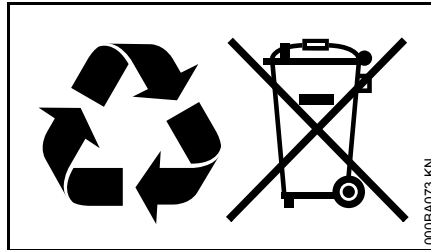

STIHL products must not be thrown in the garbage can. Take the product, accessories and packaging to an approved disposal site for environment-friendly recycling.

Contact your STIHL servicing dealer for the latest information on waste disposal.

## EC Declaration of Conformity

ANDREAS STIHL AG & Co. KG  
Badstr. 115  
D-71336 Waiblingen

Germany

confirms that the product described below

Category:	KombiEngine
Make:	STIHL
Model:	KM 94 RC-E
Serial identification:	4149
Displacement	24.1 cc

conforms to the relevant requirements of the Directives 2006/42/EC and 2004/108/EC (up to 19.04.2016), 2014/30/EU (from 20.04.2016) and has been developed and manufactured in compliance with the following standards in the versions valid at the time of production:

EN ISO 12100, EN 55012, EN 61000-6-1 (in conjunction with the following KombiTools: BF-KM, BG-KM, FCB-KM, FCS-KM, FH-KM, FS-KM, FSB-KM, HL-KM, HT-KM, KB-KM, KW-KM and SP-KM).

The KombiEngine described here may be operated only in conjunction with the KombiTools approved by STIHL for use with this KombiEngine.

Technical documents deposited at:

ANDREAS STIHL AG & Co. KG  
Produktzulassung (Product Licensing)

The year of manufacture and serial number are applied to the product.



Done at Waiblingen, 11.03.2016  
ANDREAS STIHL AG & Co. KG



Thomas Elsner  
Director Product Management and  
Services



*English*



0458-467-0121-A

englisch



[www.stihl.com](http://www.stihl.com)



0458-467-0121-A