

# HILTI

## SD 5000-A22

Deutsch	de
English	en
Français	fr
Italiano	it
Español	es
Português	pt
Nederlands	nl
Dansk	da
Svenska	sv
Norsk	no
Suomi	fi
Ελληνικά	el
Magyar	hu
Polski	pl
Русский	ru
Česky	cs
Slovenčina	sk
Hrvatski	hr
Slovenščina	sl
Български	bg
Română	ro
Türkçe	tr
عربي	ar
Latviešu	lv
Lietuvių	lt
Eesti	et
日本語	ja
한국어	ko

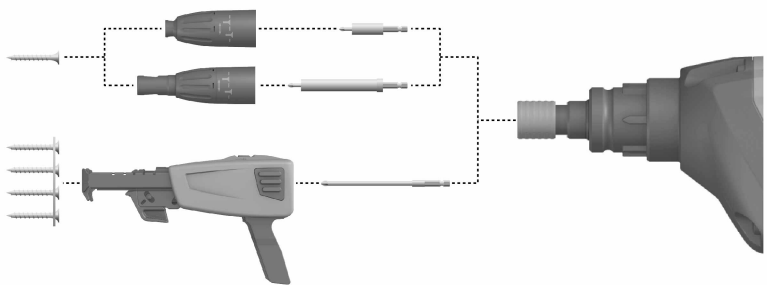

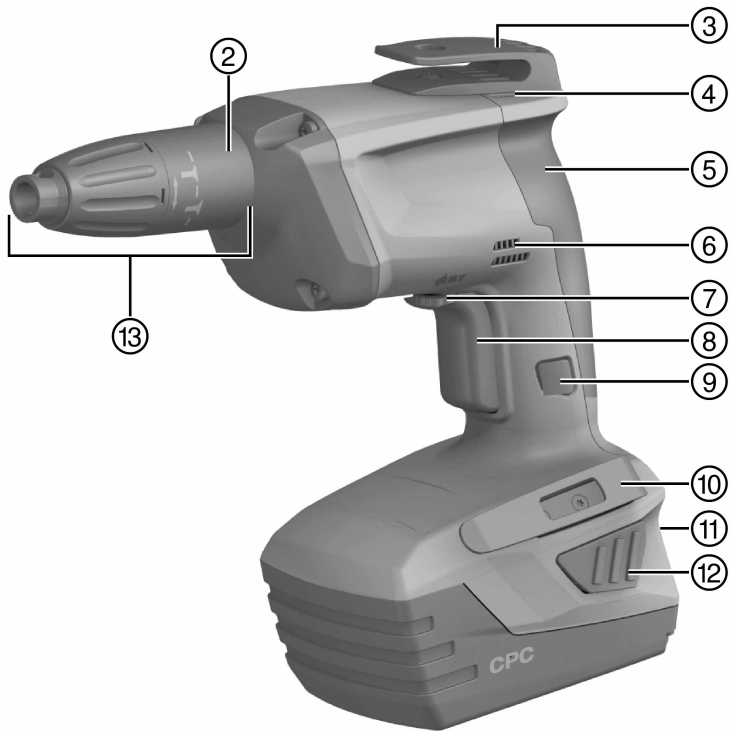
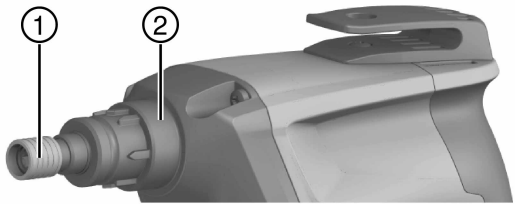

2



3

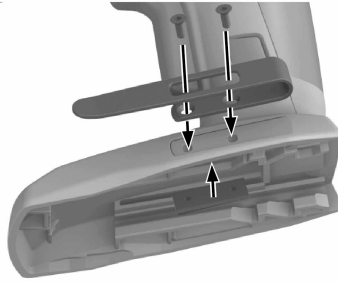

4



5

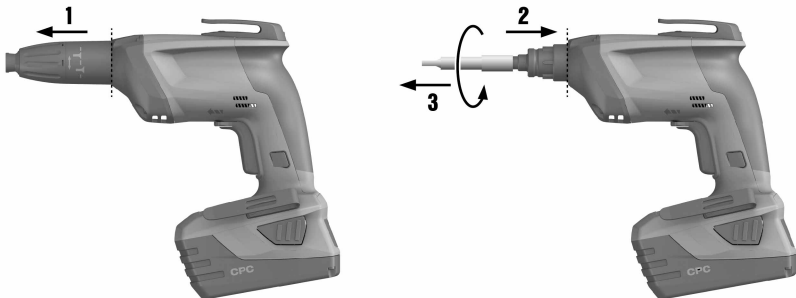

6

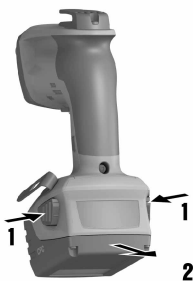

7

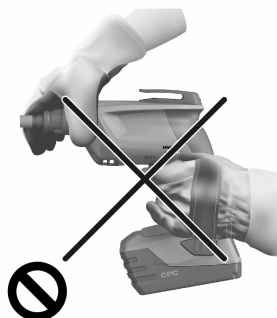
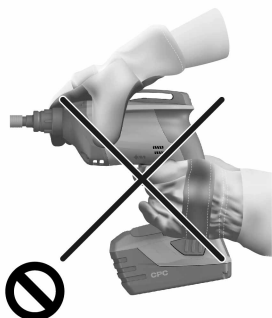

8



9

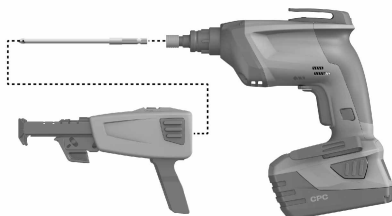
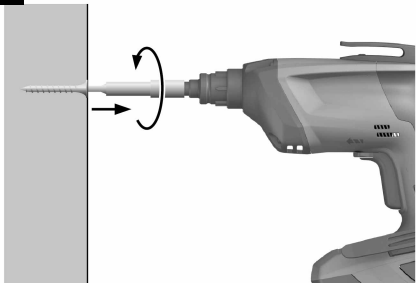

# SD 5000-A22



de	Original-Bedienungsanleitung	1
en	Original operating instructions	12
fr	Mode d'emploi original	23
it	Istruzioni originali	34
es	Manual de instrucciones original	45
pt	Manual de instruções original	56
nl	Originele handleiding	67
da	Original brugsanvisning	78
sv	Originalbruksanvisning	88
no	Original bruksanvisning	98
fi	Alkuperäiset ohjeet	108
el	Πρωτότυπες οδηγίες χρήσης	118
hu	Eredeti használati utasítás	130
pl	Oryginalna instrukcja obsługi	141
ru	Оригинальное руководство по эксплуатации	152
cs	Originální návod k obsluze	164
sk	Originálny návod na obsluhu	174
hr	Originalne upute za uporabu	185
sl	Originalna navodila za uporabo	196
bg	Оригинално Ръководство за експлоатация	207
ro	Manual de utilizare original	218
tr	Orijinal kullanım kılavuzu	229
ar	دليل الاستعمال الأصلي	240
lv	Originālā lietošanas instrukcija	251
lt	Originali naudojimo instrukcija	262
et	Originaalkasutusjuhend	273
ja	オリジナル取扱説明書	283
ko	오리지널 사용설명서	294

## 1 Information about the documentation

### 1.1 Explanation of signs used



#### 1.1.1 Warnings

Warnings alert persons to hazards that occur when handling or using the product. The following signal words are used in combination with a symbol:

	<b>DANGER!</b> Draws attention to imminent danger that will lead to serious personal injury or fatality.
	<b>WARNING!</b> Draws attention to a potentially dangerous situation that could lead to serious personal injury or fatality.
	<b>CAUTION!</b> Draws attention to a potentially dangerous situation that could lead to slight personal injury or damage to the equipment or other property.

#### 1.1.2 Symbols

The following symbols are used:

	Draws attention to instructions or other useful information.
	Read the operating instructions before use.
$n_0$	Rated speed under no load
/min	Revolutions per minute
RPM	Revolutions per minute
	Direct current (DC)

#### 1.1.3 Illustrations

The illustrations in these operating instructions are intended to convey a basic understanding and may differ from the actual version of the product:

<b>2</b>	These numbers refer to the corresponding illustrations found at the beginning of these operating instructions.
<b>3</b>	The numbering in the illustrations reflects the order of the work steps in the illustration and may deviate from the numbering of work steps in the text.
<b>11</b>	Item reference numbers are used in the overview illustration. In the product overview section, the numbers shown in the legend relate to these item reference numbers.

### 1.2 About this documentation

- ▶ Read these operating instructions before the product is used or operated for the first time. This is a prerequisite for safe, trouble-free handling and use of the product.
- ▶ Observe the safety instructions and warnings in this documentation and on the tool.
- ▶ Always keep the operating instructions with the power tool and make sure that they are with the power tool when it is given to other persons.

We reserve the right to make changes. Errors excepted.

### 1.3 Product information

Hilti products are designed for professional use and may be operated, serviced and maintained only by trained, authorized personnel. This personnel must be informed of any particular hazards that may be encountered. The product and its ancillary equipment may present hazards when used incorrectly by untrained personnel or when used not as directed.

- Make a note of the designation and serial number printed on the identification plate in the following table.
- ▶ Always quote this information when you contact a Hilti representative or Hilti Service to enquire about the product.

## Product information

Type:	
Generation:	01
Serial number:	

## 2 Safety

### 2.1 Safety instructions

The safety instructions listed in the following section include all general safety instructions for power tools which, in accordance with the applicable standards, require to be listed in the operating instructions. Accordingly, some of the instructions listed may not be relevant to this power tool.

#### 2.1.1 General power tool safety warnings

##### WARNING

**Read all safety warnings and all instructions.** Failure to follow the warnings and instructions may result in electric shock, fire and/or serious injury.

**Save all warnings and instructions for future reference.**

The term “power tool” in the warnings refers to your mains-operated (corded) power tool or battery-operated (cordless) power tool.

##### Work area safety

- ▶ **Keep work area clean and well lit.** Cluttered or dark areas invite accidents.
- ▶ **Do not operate power tools in explosive atmospheres, such as in the presence of flammable liquids, gases or dust.** Power tools create sparks which may ignite the dust or fumes.
- ▶ **Keep children and bystanders away while operating a power tool.** Distractions can cause you to lose control.

##### Electrical safety

- ▶ **Power tool plugs must match the outlet. Never modify the plug in any way. Do not use any adapter plugs with earthed (grounded) power tools.** Unmodified plugs and matching outlets will reduce risk of electric shock.
- ▶ **Avoid body contact with earthed or grounded surfaces, such as pipes, radiators, ranges and refrigerators.** There is an increased risk of electric shock if your body is earthed or grounded.
- ▶ **Do not expose power tools to rain or wet conditions.** Water entering a power tool will increase the risk of electric shock.
- ▶ **Do not abuse the cord. Never use the cord for carrying, pulling or unplugging the power tool. Keep cord away from heat, oil, sharp edges or moving parts.** Damaged or entangled cords increase the risk of electric shock.
- ▶ **When operating a power tool outdoors, use an extension cord suitable for outdoor use.** Use of a cord suitable for outdoor use reduces the risk of electric shock.
- ▶ **If operating a power tool in a damp location is unavoidable, use a residual current device (RCD) protected supply.** Use of an RCD reduces the risk of electric shock.

##### Personal safety

- ▶ **Stay alert, watch what you are doing and use common sense when operating a power tool. Do not use a power tool while you are tired or under the influence of drugs, alcohol or medication.** A moment of inattention while operating power tools may result in serious personal injury.
- ▶ **Use personal protective equipment. Always wear eye protection.** Protective equipment such as dust mask, non-skid safety shoes, hard hat, or hearing protection used for appropriate conditions will reduce personal injuries.
- ▶ **Prevent unintentional starting. Ensure the switch is in the off-position before connecting to power source and/or battery pack, picking up or carrying the tool.** Carrying power tools with your finger on the switch or energising power tools that have the switch on invites accidents.
- ▶ **Remove any adjusting key or wrench before turning the power tool on.** A wrench or a key left attached to a rotating part of the power tool may result in personal injury.
- ▶ **Do not overreach. Keep proper footing and balance at all times.** This enables better control of the power tool in unexpected situations.
- ▶ **Dress properly. Do not wear loose clothing or jewellery. Keep your hair, clothing and gloves away from moving parts.** Loose clothes, jewellery or long hair can be caught in moving parts.

- ▶ **If devices are provided for the connection of dust extraction and collection facilities, ensure these are connected and properly used.** Use of dust collection can reduce dust-related hazards.

#### **Power tool use and care**

- ▶ Do not force the power tool. Use the correct power tool for your application. The correct power tool will do the job better and safer at the rate for which it was designed.
- ▶ **Do not use the power tool if the switch does not turn it on and off.** Any power tool that cannot be controlled with the switch is dangerous and must be repaired.
- ▶ **Disconnect the plug from the power source and/or the battery pack from the power tool before making any adjustments, changing accessories, or storing power tools.** Such preventive safety measures reduce the risk of starting the power tool accidentally.
- ▶ **Store idle power tools out of the reach of children and do not allow persons unfamiliar with the power tool or these instructions to operate the power tool.** Power tools are dangerous in the hands of untrained users.
- ▶ **Maintain power tools. Check for misalignment or binding of moving parts, breakage of parts and any other condition that may affect the power tool's operation. If damaged, have the power tool repaired before use.** Many accidents are caused by poorly maintained power tools.
- ▶ **Keep cutting tools sharp and clean.** Properly maintained cutting tools with sharp cutting edges are less likely to bind and are easier to control.
- ▶ **Use the power tool, accessories and tool bits etc. in accordance with these instructions, taking into account the working conditions and the work to be performed.** Use of the power tool for operations different from those intended could result in a hazardous situation.

#### **Battery tool use and care**

- ▶ **Recharge only with the charger specified by the manufacturer.** A charger that is suitable for one type of battery pack may create a risk of fire when used with another battery pack.
- ▶ **Use power tools only with specifically designated battery packs.** Use of any other battery packs may create a risk of injury and fire.
- ▶ **When battery pack is not in use, keep it away from other metal objects, like paper clips, coins, keys, nails, screws or other small metal objects, that can make a connection from one terminal to another.** Shorting the battery terminals together may cause burns or a fire.
- ▶ **Under abusive conditions, liquid may be ejected from the battery; avoid contact. If contact accidentally occurs, flush with water. If liquid contacts eyes, additionally seek medical help.** Liquid ejected from the battery may cause irritation or burns.

#### **Service**

- ▶ **Have your power tool serviced by a qualified repair person using only identical replacement parts.** This will ensure that the safety of the power tool is maintained.

### **2.1.2 Drill/driver safety warnings**

- ▶ **Hold power tool by insulated gripping surfaces, when performing an operation where the fastener may contact hidden wiring.** Fasteners contacting a "live" wire may make exposed metal parts of the power tool "live" and could give the operator an electric shock.

### **2.1.3 Additional safety instructions**

#### **Personal safety**

- ▶ **Tampering with or modification of the power tool is not permitted.**
- ▶ **Wear ear protectors.** Exposure to noise can cause hearing loss.
- ▶ **Keep the tool, especially its grip surfaces, clean and free from oil and grease. Do not use cleaning agents containing silicone.**
- ▶ **Improve the blood circulation in your fingers by relaxing your hands and exercising your fingers during breaks between working.**
- ▶ **Avoid touching rotating parts. Switch the power tool on only after bringing it into position at the workpiece.** Touching rotating parts, especially rotating tools or other accessories, may lead to injury.
- ▶ **Activate the safety lock (forward / reverse selector switch in the middle position) when storing or transporting the tool.**
- ▶ **The power tool is not intended for use by inexperienced persons who have received no special training.**
- ▶ **Keep the power tool out of reach of children.**
- ▶ **Avoid unintentional starting. Never carry the power tool with your finger on the on/off switch. Remove the battery from the power tool during work breaks, before carrying out maintenance, before changing accessory tools and before transporting the power tool.**



- ▶ **Check that the belt hook is fitted securely before beginning work.**
- ▶ **Do not carry the power tool by the depth gauge.** This clip-on part could pull off inadvertently.
- ▶ **Check that the power tool is placed in a secure position when it is laid down, especially when used with the magazine and / or extension.**
- ▶ **Check that accessory tools are compatible with the power tool's chuck/drive system and that they are fitted and secured correctly.**
- ▶ Dust from material such as paint containing lead, some wood species, minerals and metal may be harmful. Contact with or inhalation of the dust may cause allergic reactions and/or respiratory diseases among operators or bystanders. Certain kinds of dust such as oak and beech wood dust are classified as carcinogenic, especially in conjunction with additives for wood conditioning (chromate, wood preservative). Material containing asbestos may be worked on only by specialists. **Use a dust removal system that is as effective as possible. Accordingly, use a suitable vacuum cleaner of the type recommended by Hilti for wood dust and/or mineral dust and which is designed for use with this power tool. Ensure that the workplace is well ventilated. Observe national regulations applicable to the materials you intend to work with.**
- ▶ **Observe the nationally applicable industrial safety regulations.**

#### Electrical safety

- ▶ **Before beginning work, check the working area (e.g. using a metal detector) to ensure that no concealed electric cables or gas and water pipes are present.** External metal parts of the tool may become live, for example, when an electric cable is damaged accidentally. This presents a serious risk of electric shock.

#### Personal safety

- ▶ **The user and all other persons in the vicinity must wear suitable protective equipment including protective glasses, a hard hat, ear protection, protective gloves and light respiratory protection while the power tool is in use.**

#### Use and care of battery-powered tools

- ▶ **Check that the tool is switched off before inserting the battery.** Inserting a battery into an electric tool that is switched on can lead to accidents.
- ▶ **Do not expose batteries to high temperatures and keep them away from fire.** There is a risk of explosion.
- ▶ **Do not disassemble, crush or incinerate batteries and do not subject them to temperatures over 80°C (176°F).** This presents a risk of fire, explosion or injury through contact with caustic substances.
- ▶ **Avoid ingress of moisture.** Ingress of moisture may cause a short circuit, resulting in burning injuries or fire.
- ▶ **Observe the special guidelines applicable to the transport, storage and use of lithium-ion batteries.**
- ▶ **Avoid short circuiting the battery terminals. Check that the battery terminals and the terminals in the power tool are free from foreign objects before inserting the battery in the tool.** Short circuiting the battery terminals presents a risk of fire, explosion and chemical burns.
- ▶ **Do not continue to use or attempt to charge damaged batteries (e.g. batteries with cracks, broken parts, bent or pushed-in/pulled-out contacts).**
- ▶ **Do not use the battery as a power source for other unspecified power tools or appliances.**
- ▶ If the battery is too hot to touch it may be defective. **In this case, place the power tool in a non-flammable location, well away from flammable materials, where it can be kept under observation and allowed to cool down. Contact Hilti Service after the battery has cooled down.**

## 3 Description

### 3.1 Overview of the product

- |   |   |
|---|---|
| ① Chuck   | ⑧ Control switch (with electronic speed control)  |
| ② Power tool / accessory interface (snap-on connection) | ⑨ Lockbutton for continuous operation             |
| ③ Universal hook  | ⑩ Belt hook                                       |
| ④ Motor cooling air intake                              | ⑪ Charge state and fault display (Li-ion battery) |
| ⑤ Grip  | ⑫ Battery release buttons                         |
| ⑥ Air exit  | ⑬ Depth gauge                                     |
| ⑦ Forward / reverse selector switch with safety lock    |   |

### 3.2 Intended use

The product described is a hand-held cordless drywall screwdriver equipped with a clutch.

Use only the drywall screws specified in the technical data.

For optimum handling characteristics we recommend that the screwdriver is gripped in the in-line position. The motor cooling air is drawn in through the cooling air slots and blown out of the screwdriver through the air vents.

- ▶ Use only **Hilti** Li-ion batteries of the B 22 series with this product.
- ▶ Use only **Hilti** battery chargers of the C4/36 series for charging these batteries.

### 3.3 Charge state display

The charge state of the Li-ion battery is displayed after pressing one of the release buttons lightly (press only until slight resistance is felt).

Status	Meaning
4 LEDs light.	• Charge state: 75 % to 100 %
3 LEDs light.	• Charge state: 50 % to 75 %
2 LEDs light.	• Charge state: 25 % to 50 %
1 LED lights.	• Charge state: 10 % to 25 %
1 LED blinks.	• Charge state: < 10 %



#### Note

Battery charge state cannot be displayed while the control switch is pressed and for up to 5 seconds after releasing the control switch.

### 3.4 Items supplied

Drywall screwdriver, depth gauge, bit, bit holder, operating instructions



#### Note

You can find other system products approved for use with your product at your local **Hilti** Center or online at: [www.hilti.com](http://www.hilti.com).

### 3.5 Depth gauge

The depth gauge is attached to the screwdriver by way of a snap-on connection and can be simply pulled off or pushed on. The optimum screwdriving depth can be set by turning the depth gauge. The further the depth gauge is turned, i.e. bringing it closer to the screwdriver body, the deeper the screws will be driven.

### 3.6 Accessory tools

Among the accessory tools available are the bit holder and magazine bit. The chuck for the accessory tools becomes accessible after removing the depth gauge or the magazine.

#### 3.6.1 Bit holder

The bit holder is used when no magazine is fitted.

#### 3.6.2 Magazine bit

The magazine bit must be used in conjunction with the magazine.

### 3.7 Lockbutton for continuous operation

The screwdriver can be set to sustained operating mode by pressing the lockbutton. It is then no longer necessary to maintain constant pressure on the control switch.

### 3.8 Overloading and overheating protection

The drywall screwdriver is protected from overloading and overheating by an automatic cut-out. Overloading or overheating is indicated by the four LEDs blinking. After overheating, when the control switch is pressed to restart the screwdriver, there may be a delay before the screwdriver restarts.

### 3.9 Belt hook

Using the belt hook, the drywall screwdriver can be carried conveniently, close to the body, on a belt. The belt hook can be fitted to allow attachment on the left or right side of the body.

### 3.10 Universal hook

The universal hook allows the screwdriver to be put aside or stored temporarily in a number of different ways. If the hook is not required it can be removed by unscrewing the two retaining screws.

## 4 Technical data

### 4.1 Screwdriver

Rated voltage	21.6 V
Weight in accordance with EPTA procedure 01/2003	2.1 kg
Rated speed under no load	0 rpm ... 5,000 rpm
Maximum torque	9.5 Nm
Socket/bit drive	Hex socket 1/4"
Screw length	≤ 55 mm
Screw diameter	≤ 4.2 mm

### 4.2 Noise information and vibration values determined in accordance with EN 60745

The sound pressure and vibration values given in these instructions have been measured in accordance with a standardized test and may be used to compare one electric tool with another. They may be used for a preliminary assessment of exposure. The data given represents the main applications of the electric tool. However, if the electric tool is used for different applications, with different accessory tools, or is poorly maintained, the data may vary. This may significantly increase exposure over the total working period. An accurate estimation of exposure should also take into account the times when the power tool is switched off, or when it is running but not actually in use for a task. This may significantly reduce exposure over the total working period. Identify additional safety measures to protect the operator from the effects of noise and/or vibration, for example: maintain the tool and the accessories, keep the hands warm, organization of work patterns.

#### Noise information in accordance with EN 60745

Sound (power) level ( $L_{WA}$ )	82 dB(A)
Uncertainty for the sound power level ( $K_{WA}$ )	3 dB(A)
Emission sound pressure level ( $L_{pA}$ )	71 dB(A)
Uncertainty for the sound pressure level ( $K_{pA}$ )	3 dB(A)

#### Total vibration (vector sum of three directions), measured in accordance with EN 60745

Vibration emission value for screwdriving without impact action, ( $a_{WA}$ )	1 m/s <sup>2</sup>
Uncertainty for screwdriving	1.5 m/s <sup>2</sup>

## 5 Preliminary and finishing work

### 5.1 Charging the battery



#### Note

Make sure that the outer surfaces of the battery are clean and dry before inserting the battery in an approved battery charger.

Read the operating instructions for the charger for further information about the charging procedure.

- ▶ Use an approved charger to charge the battery.

## 5.2 Inserting the battery 2



### WARNING

**Risk of injury!** Inadvertent starting of the screwdriver.

- ▶ Before fitting the battery, check that the screwdriver is switched off and that the forward / reverse switch is in the middle position (i.e. safety lock engaged).



### WARNING

**Risk of injury!** Hazard presented by a falling battery.

- ▶ A falling battery may present a risk of injury to yourself and others. Check that the battery is securely seated in the power tool.



### WARNING

**Electrical hazard!** Risk of short circuiting.

- ▶ Before inserting the battery, check to ensure that the battery terminals and the contacts on the screwdriver are free from foreign objects.

- ▶ Insert the battery.

## 5.3 Fitting the belt hook in the alternative position 3

1. Press both battery release buttons simultaneously and pull the battery out of the screwdriver.
2. Unscrew both belt hook retaining screws.
3. Bring the belt hook and threaded piece into place on the other side of the tool.
4. Reinsert and tighten the two retaining screws.

## 5.4 Working safely with the belt hook and universal hook

- ▶ Before beginning work, make sure that the belt hook and universal hook are securely attached to the screwdriver.
- ▶ Use the universal hook only when necessary. Lay the screwdriver down in a safe place when it is not in use for a long period.

## 5.5 Forward / reverse 4



### Note

The control switch is locked when the forward / reverse switch is in the middle position (safety lock).

- ▶ Set the forward / reverse selector switch to forward or reverse rotation.

## 5.6 Changing the bit

1. Pull the depth gauge away from the power tool, releasing the snap-on connection.
2. Change the bit.
3. Refit the depth gauge to the power tool.

## 5.7 Changing the accessory tool. 5

1. Pull the depth gauge away from the power tool, releasing the snap-on connection.
2. Push the chuck towards the screwdriver, turning the chuck slightly at the same time, and then hold it in this position.
3. Remove the accessory tool with your other hand.
4. Insert the desired accessory tool in the chuck, pushing it into the screwdriver as far as it will go.

## 5.8 Removing the battery 6

- ▶ Press both battery release buttons simultaneously and pull the battery out of the screwdriver.

## 5.9 Transport and storage of batteries

Observe the nationally and internationally applicable transport regulations when shipping batteries by road, rail, sea or air.

## 6 Driving and removing screws

### 6.1 Driving screws 7



#### WARNING

**Electrical hazards** There is a risk of electric shock if a screw is driven into a concealed electric cable and, at the same time, the bit holder or depth gauge is touched.

- ▶ Hold the screwdriver only by the grip when driving or removing screws.

1. Set the screwdriver to forward rotation.
2. Check that the battery is in the working position.
3. Position the screw on the bit and bring the tip of the screw into contact with the working surface.
4. Use the control switch to regulate the speed of the screwdriver.

### 6.2 Removing screws

1. Pull the depth gauge off.
2. Set the screwdriver to reverse rotation.
3. Insert the bit in the head of the screw and use the control switch to regulate the speed of the screwdriver.
4. Refit the depth gauge after removing the screws.

### 6.3 Switching on in sustained operating mode 8

- ▶ Switch on in sustained operating mode.

### 6.4 Switching off after sustained operation

- ▶ Press the control switch.
  - ◀ The lockbutton returns to its original position.

### 6.5 Screwdriver / depth gauge interface 9



#### Note

With the drive spindle exposed in this way, the following operations can be carried out:

Removing screws (set to reverse rotation),  
changing bits,  
changing bit holders,  
changing to magazine mode with the SMD 57 magazine,  
redriving screws.

- ▶ Pull the depth gauge away from the power tool, releasing the snap-on connection.

## 7 Care and maintenance

### 7.1 Care of the product



#### WARNING

**Electrical hazards!** Improper repairs to electrical parts may lead to serious injuries.

- ▶ Electrical parts may be repaired only by trained electrical specialists.



#### Note

To help ensure safe and reliable operation, use only genuine Hilti spare parts and consumables. Spare parts, consumables and accessories approved by Hilti for use with the product can be found at your local **Hilti** Center or online at: **www.hilti.com**

- ▶ Keep the screwdriver, especially its grip surfaces, clean and free from oil and grease. Do not use cleaning agents containing silicone.
- ▶ Never operate the product when the air vents are blocked. Clean the air vents carefully using a dry brush. Do not permit foreign objects to enter the interior of the screwdriver.
- ▶ Clean the outer surfaces of the power tool with a damp cloth at regular intervals.
- ▶ Do not use a spray, pressure jet washer or running water for cleaning. This may negatively affect the electrical safety of the screwdriver.

## 8 Troubleshooting



### Note

If the trouble you are experiencing is not listed in this table or you are unable to remedy the problem by yourself, please contact **Hilti** Service.

Trouble or fault	Possible cause	Action to be taken
The screwdriver doesn't work.	Low battery.	▶ Use an approved charger to charge the battery. → page 17
	The battery is not in the working position.	▶ Insert the battery. → page 18
The screwdriver doesn't work and one LED blinks.	Low battery.	▶ Change or charge the battery.
	The battery is too hot or too cold.	▶ Bring the battery to the recommended operating temperature.
The screwdriver doesn't work and all four LEDs blink.	The overload cut-out has been activated.	▶ Release the control switch and then press it again. Reduce the load on the tool.
The control switch can't be pressed, i.e. the switch is locked.	The safety lock is engaged.	▶ Set the forward / reverse selector switch to forward or reverse rotation.
The screwdriver runs but the screw can't be driven.	The wrong direction of rotation is set.	▶ Use the forward / reverse selector switch to set the right direction of rotation.
Running speed suddenly drops considerably.	Low battery.	▶ Use an approved charger to charge the battery. → page 17
The battery runs down more quickly than usual.	Battery condition is not optimal.	▶ Have the battery condition diagnosed by <b>Hilti</b> Service or fit a new battery.
The battery doesn't engage with an audible click.	The retaining lugs on the battery are dirty.	▶ Clean the retaining lugs and engage the battery in the working position.
The screwdriver or the battery gets very hot.	Electrical fault.	▶ Switch the screwdriver off immediately, remove the battery and contact <b>Hilti</b> Service.
	The screwdriver has been overloaded by exceeding its application limits.	▶ Select a screwdriver with adequate performance for the application.

## 9 Disposal



### WARNING

**Risk of injury.** Hazards presented by improper disposal.

- ▶ Improper disposal of the equipment may have the following consequences: The burning of plastic components generates toxic fumes which may present a health hazard. Batteries may explode if damaged or exposed to very high temperatures, causing poisoning, burns, acid burns or environmental pollution. Careless disposal may permit unauthorized and improper use of the equipment. This may result in serious personal injury, injury to third parties and pollution of the environment.
- ▶ Dispose of defective batteries right away. Keep them out of reach of children. Do not disassemble or incinerate the batteries.
- ▶ Batteries that have reached the end of their life must be disposed of in accordance with national regulations or returned to **Hilti**.

 Most of the materials from which **Hilti** tools and appliances are manufactured can be recycled. The materials must be correctly separated before they can be recycled. In many countries, your old tools, machines or appliances can be returned to **Hilti** for recycling. Ask **Hilti** Service or your Hilti representative for further information.

In accordance with the European Directive on waste electrical and electronic appliances and its implementation in conformance with national law, electrical and electronic appliances that have reached the end of their life must be collected separately and returned to an environmentally compatible recycling facility.



- ▶ Do not dispose of electrical and electronic appliances together with household waste!

## 10 Manufacturer's warranty

- ▶ Please contact your local **Hilti** representative if you have questions about the warranty conditions.

## 11 EC declaration of conformity

### Manufacturer

Hilti Aktiengesellschaft  
Feldkircherstrasse 100  
9494 Schaan  
Liechtenstein

We declare, on our sole responsibility, that this product complies with the following directives and standards.

Designation	Drywall screwdriver
Type designation	SD 5000-A22
Generation	01
Year of design	2009

Applicable directives:	<ul style="list-style-type: none"> <li>• 2004/108/EC (up to April 19, 2016)</li> <li>• 2014/30/EU (as of April 20, 2016)</li> <li>• 2006/42/EC</li> <li>• 2006/66/EC</li> <li>• 2011/65/EU</li> </ul>
------------------------	---

Applicable standards:	<ul style="list-style-type: none"> <li>• EN 60745-1, EN 60745-2-2</li> <li>• EN ISO 12100</li> </ul>
-----------------------	--

Technical documentation filed at:

- Electric Tools Approval Department  
Hilti Entwicklungsgesellschaft mbH  
Hiltistraße 6  
86916 Kaufering  
**Germany**

Schaan, 12/2015



Gunnar Wald

(Head of Quality, Business Unit Installation Systems)



Lars Taenzer

(Head of BU Direct Fastening)





Hilti Corporation

LI-9494 Schaan

Tel.: +423/234 21 11

Fax: +423/234 29 65

[www.hilti.com](http://www.hilti.com)



400171