

Operator's manual Manual d'utilisation Manual de instrucciones

Hedge Trimmer Attachment HA 110 HA 850

Complément Taille-haie HA 110 HA 850

Tijeras cortasetos (suplemento) HA 110 HA 850

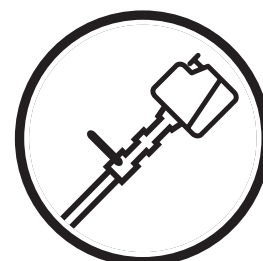

GB FR ES

KEY TO SYMBOLS

Symbols

WARNING!

Incorrect or careless use of a hedge trimmer can turn it into a dangerous tool that can cause serious or even fatal injury. It is extremely important that you read and understand the contents of this operator's manual.



Please read the operator's manual carefully and make sure you understand the instructions before using the machine.



Always wear:

- Approved hearing protection
- Protective goggles or a visor



This product is in accordance with applicable EC directives.



Cutting tool. Do not touch the tool without first switching off the engine.



This machine is not electrically insulated. If the machine touches or comes close to high-voltage power lines it could lead to death or serious bodily injury. Electricity can jump from one point to another by arcing. The higher the voltage, the greater the distance electricity can jump. Electricity can also travel through branches and other objects, especially if they are wet. Always keep a distance of at least 10 m between the machine and high-voltage power lines and/or any objects that are touching them. If have to work within this safe distance you should always contact the relevant power company to make sure the power is switched off before you start work.

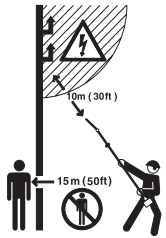

This machine can be dangerous! The operator of the machine must ensure, while working, that no persons or animals come closer than 15 metres.

Arrows which show limits for handle positioning.



Always wear approved protective gloves.



Wear sturdy, non-slip boots.



Noise emission to the environment according to the European Community's Directive. The machine's emission is specified in chapter Technical data and on label.



Other symbols/decals on the machine refer to special certification requirements for certain markets.

Switch off the engine by moving the stop switch to the STOP position before carrying out any checks or maintenance.

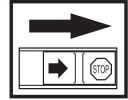

Always wear approved protective gloves.



Regular cleaning is required.

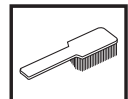

Visual check.



Protective goggles or a visor must be worn.



CONTENTS

Contents

KEY TO SYMBOLS

Symbols 2

CONTENTS

Contents 3

Note the following before starting: 3

SAFETY INSTRUCTIONS

Machine's safety equipment 4

Checking, maintaining and servicing the machine's safety equipment 4

Safety instructions when using the hedge trimmer 5

WHAT IS WHAT?

What is what on the hedge trimmer attachment? (HA 110)..... 7

What is what on the hedge trimmer attachment? (HA 850)..... 8

ASSEMBLY

Fitting the hand guard and loop handle (HA 110)..... 9

Fitting the cutting head 9

STARTING AND STOPPING

Check before starting 10

MAINTENANCE

Gear housing 11

Cleaning and lubrication 11

Maintenance schedule 11

TECHNICAL DATA

Technical data 11

Note the following before starting:

Husqvarna AB has a policy of continuous product development and therefore reserves the right to modify the design and appearance of products without prior notice.

Long-term exposure to noise can result in permanent hearing impairment. So always use approved hearing protection.



WARNING! Under no circumstances may the design of the machine be modified without the permission of the manufacturer. Always use genuine accessories. Non-authorized modifications and/or accessories can result in serious personal injury or the death of the operator or others.



WARNING! This accessory may only be used together with the intended clearing saw/trimmer, see under heading "Approved accessories" in chapter Technical data in the machine's Operator's Manual.

The machine is only designed for cutting branches and twigs.

SAFETY INSTRUCTIONS

Machine's safety equipment

This section describes the machine's safety equipment, its purpose, and how checks and maintenance should be carried out to ensure that it operates correctly. See the "What is what?" section to locate where this equipment is positioned on your machine.

The life span of the machine can be reduced and the risk of accidents can increase if machine maintenance is not carried out correctly and if service and/or repairs are not carried out professionally. If you need further information please contact your nearest service workshop.



Hand guard

(HA 110)

The hand guard prevents hands from coming into contact with the moving blades, for example, if the operator loses grip on the front handle.

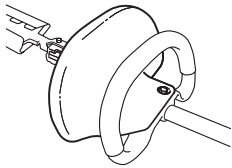

Blade guard

(HA 110)

The blade guard (A) is intended to protect against any part of the body coming into contact with the blades (B).

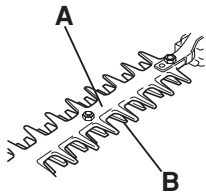

Checking, maintaining and servicing the machine's safety equipment

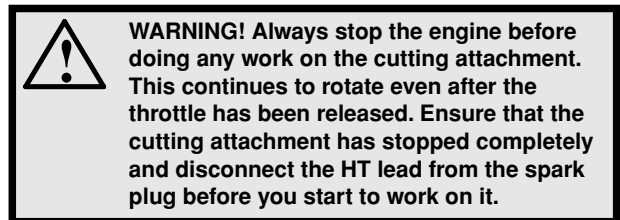
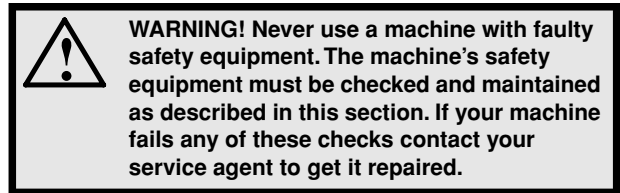

Hand guard

(HA 110)

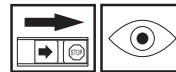

- Check that the hand guard is fitted correctly.
- Check that the hand guard is undamaged.

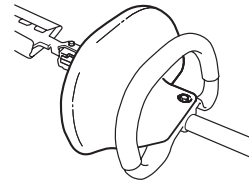

Blades

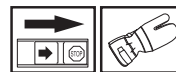

To ensure good cutting results it is important that the contact pressure between the blades is correct. The contact pressure is adjusted by turning the screws on the underside of the bar clockwise as far as they will go. Then turn the screws anticlockwise a 1/4 turn. Lock the screws using the locking nut on the top of the bar. Check that the screws are loose enough to allow the washers under the screw heads to slide sideways.

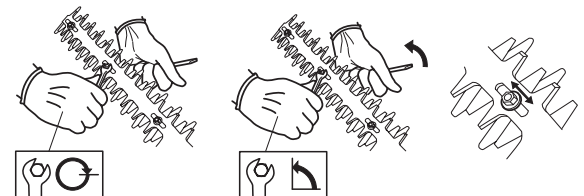

When the blades are correctly adjusted the play between the blades should be 0,2–0,4 mm, measured at the screws.

The edges of the blades are too hard to be filed. Dull blades should be sharpened using a grinder.

Replace the blades if they are bent or damaged.

SAFETY INSTRUCTIONS

Blade guard

(HA 110)



- Check that the blade guard is not damaged or distorted.
- Replace the blade guard if it is bent or damaged.

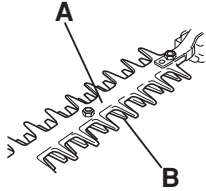

Gear housing

- The gear housing gets hot when the machine has been in use. To avoid burning yourself do not touch the gear housing.

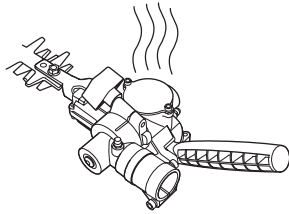

Safety instructions when using the hedge trimmer

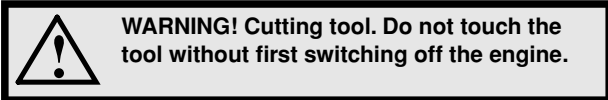
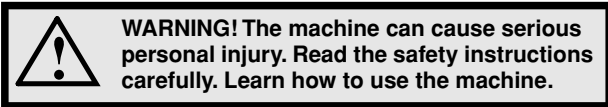

CAUTION! Please read the operator's manual carefully and make sure you understand the instructions before using the machine.

Personal protection

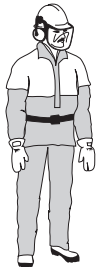

- Always wear boots and other equipment described under the heading Personal protective equipment.
- Always wear working clothes and heavy-duty long trousers.
- Never wear loose clothing or jewellery.
- Make sure your hair does not hang below shoulder level.

Safety instructions regarding the surroundings

- Never allow children to use the machine.
- Ensure that no-one comes closer than 15 m while you are working.
- Never allow anyone else to use the machine without first ensuring that they have understood the contents of the operator's manual.
- Never work from a ladder, stool or any other raised position that is not fully secured.



Safety instructions while working



- Always ensure you have a safe and stable working position
- Always use both hands to hold the machine. Hold the machine at the side of your body.

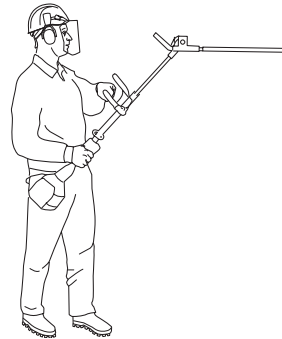

- Use your right hand to control the throttle setting.

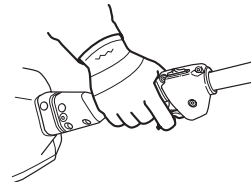

- Make sure that your hands and feet do not come near the cutting attachment when the engine is running.
- When the engine is switched off, keep your hands and feet away from the cutting attachment until it has stopped completely.
- Watch out for stumps of branches that can be thrown out during cutting.
- Always lay the machine on the ground when you are not using it.

SAFETY INSTRUCTIONS

- Do not cut too close to the ground. Stones and other objects can be thrown out.
- Check the working area for foreign objects such as electricity cables, insects and animals, etc, or other objects that could damage the cutting attachment, such as metal items.
- If any foreign object is hit or if vibrations occur stop the machine immediately. Disconnect the HT lead from the spark plug. Check that the machine is not damaged. Repair any damage.
- If anything jams in the blades while you are working, switch off the engine and wait until it has stopped completely before cleaning the blades. Disconnect the HT lead from the spark plug.

Safety instructions after completing work



- The transport guard should always be fitted to the cutting attachment when the machine is not in use.
- Make sure the cutting attachment has stopped before cleaning, carrying out repairs or an inspection. Disconnect the HT lead from the spark plug.
- Always wear heavy-duty gloves when repairing the cutting attachment. This is extremely sharp and can easily cause cuts.

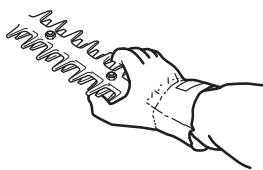

- Store the machine out of reach of children.
- Use only original spare parts for repairs.

Basic working techniques

- Work with a swinging action from the bottom upwards when trimming sides.

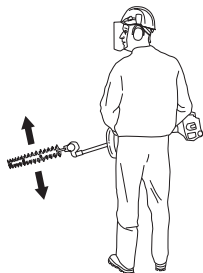

- Adjust the throttle setting to suit the load.
- When trimming a hedge the engine should always face away from the hedge.
- Hold the machine as close to your body as possible to get the best balance.

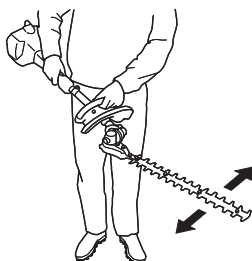

- Make sure that the tip does not touch the ground.
- Do not rush the work, but work steadily until all the branches have been cut back cleanly.

Changing the hedge trimmer angle

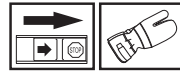

(HA 110)

- Undo the knob.

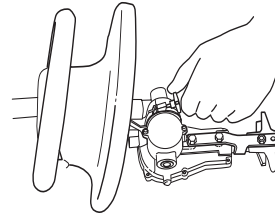

- Press the cutting head against the ground or some other solid object until the desired angle has been obtained.

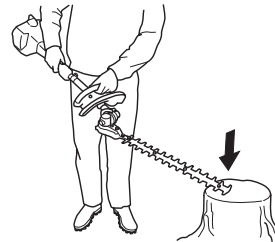

- Tighten the knob.

(HA 850)

- Undo the knob.

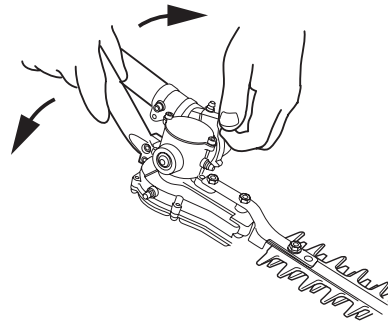

- Grasp the handle on the angle stop, adjust to the desired angle and then tighten the knob.



WARNING! Do not hold the cutting head when you adjust the angle. The blades are sharp and you could easily cut yourself.

WHAT IS WHAT?

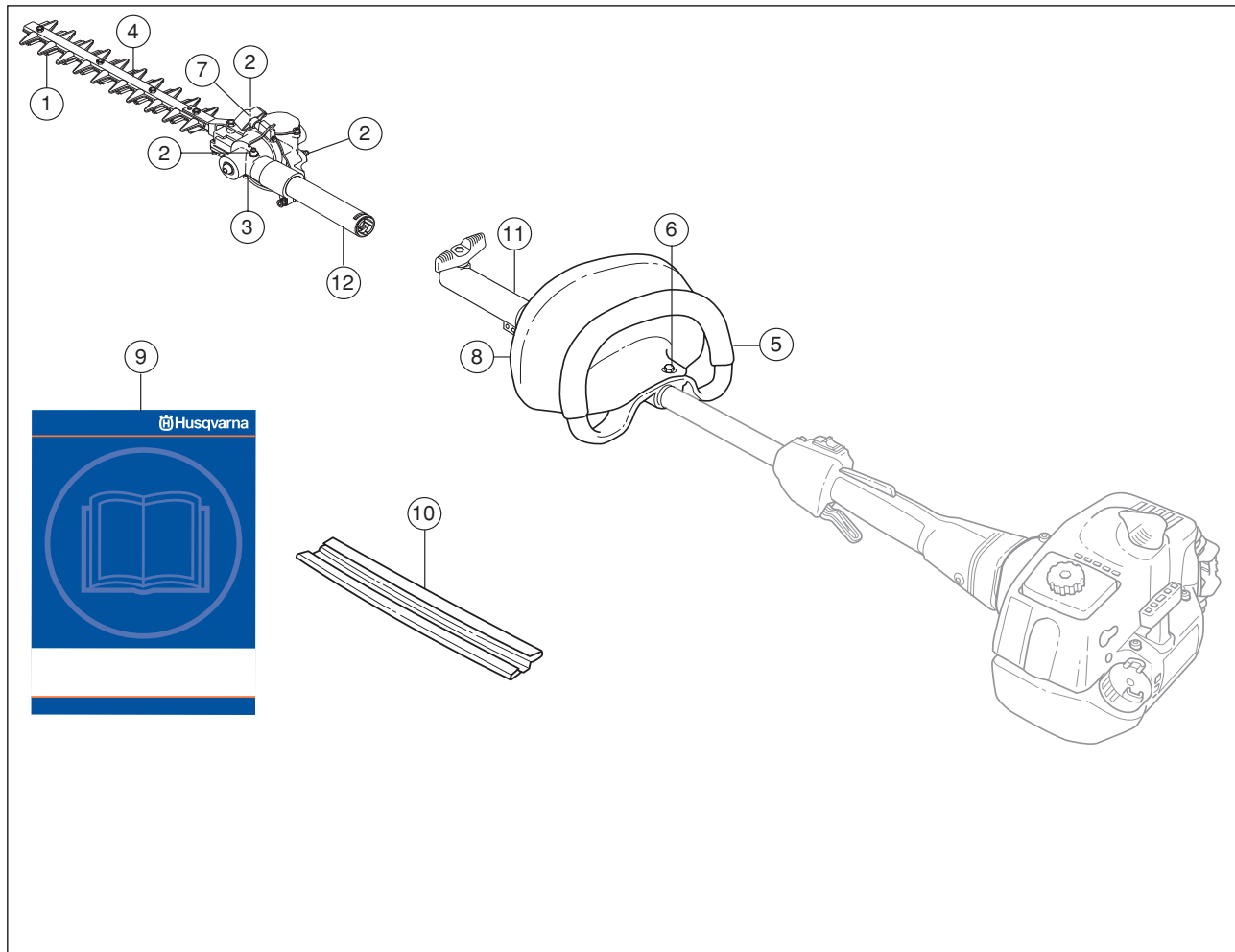

What is what on the hedge trimmer attachment? (HA 110)

- | | |
|-----------------------------|-------------------------|
| 1 Cutter | 7 Angle adjustment knob |
| 2 Grease nipples (3) | 8 Hand guard |
| 3 Bevel gear | 9 Operator's manual |
| 4 Blade guard | 10 Transport guard |
| 5 Front handle | 11 Shaft coupling |
| 6 Hand guard mounting screw | 12 Shaft (110 mm) |

WHAT IS WHAT?

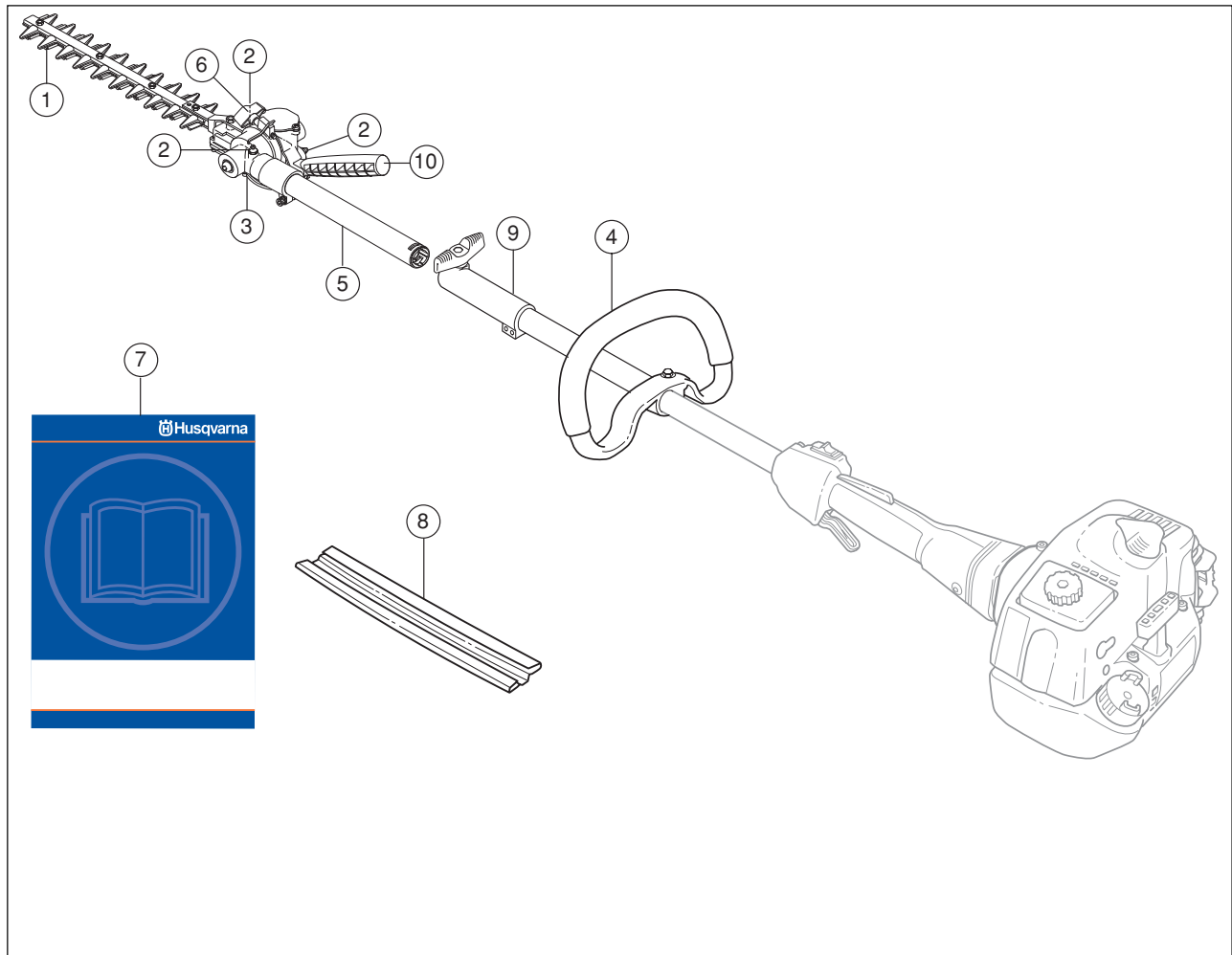

What is what on the hedge trimmer attachment? (HA 850)

- | | |
|----------------------|-------------------------|
| 1 Cutter | 6 Angle adjustment knob |
| 2 Grease nipples (3) | 7 Operator's manual |
| 3 Bevel gear | 8 Transport guard |
| 4 Front handle | 9 Shaft coupling |
| 5 Shaft (829 mm) | 10 Handle |

ASSEMBLY

Fitting the hand guard and loop handle (HA 110)

- 1 Loosen the clutch sleeve's two mounting bolts and dismantle the clutch sleeve.

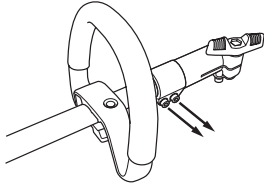

- 2 Assemble the hand guard and loop handle by screwing them together. Take care to align the holes in both parts.

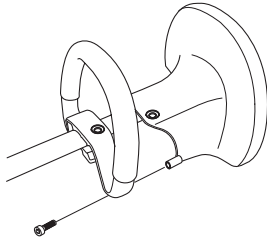

- 3 Slide the loop handle and hand guard onto the shaft.
- 4 Slide the spacer into the slot in the loop handle.
- 5 Fit the nut and screw. Do not overtighten.

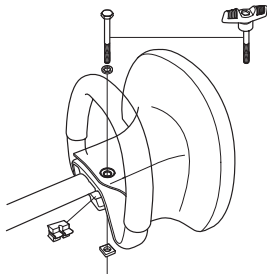

- 6 Now make a final adjustment to give yourself a comfortable working position. Tighten the screw. CAUTION! The loop handle and hand guard must not be fitted behind the arrow marked on the shaft.

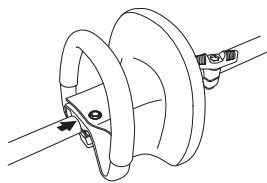

- 7 Fit the clutch sleeve and tighten the two mounting bolts.

Fitting the cutting head

It is important that the hedge trimmer is laid on a flat surface when you fit the cutting head. Otherwise the cutting head may not be fitted straight.

- 1 Fit the cutting head to the shaft. CAUTION! Make sure the drive shaft inside the shaft engages with the recess in the cutting head.

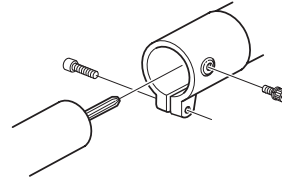

- 2 Tighten the lower screw first, then the upper screw.

STARTING AND STOPPING

Check before starting



- Inspect the working area. Remove any objects that could be thrown out.
- Check the cutting attachment. Never use blades that are dull, cracked or damaged.

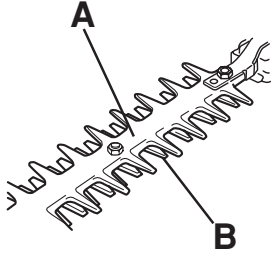

- Check that the machine is in perfect working order. Check that all nuts and screws are tight.
- Check that the blade guard is not damaged or distorted. (HA 110)
- Replace the blade guard if it is bent or damaged. (HA 110)
- Make sure the gear housing is lubricated correctly. See instructions under the heading Gear housing.
- Check that the cutting attachment always stops when the engine is idling.
- Only use the machine for the purpose it was intended for.
- Make sure that the handle and safety features are in good working order. Never use a machine that lacks a part or has been modified outside its specifications.

MAINTENANCE

Gear housing



There are three grease nipples on the gear housing. Use a grease gun to top up with grease. This should be carried out approximately every 20 working hours. Use Husqvarna special grease, part no. 503 98 96-01.

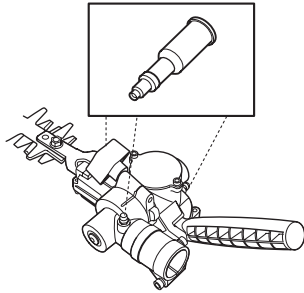

CAUTION! The gear housing must not be filled completely with grease. The grease expands as the machine heats up during operation. If the gear housing was completely filled with grease it could damage the seals and lead to leakage of grease.

The grease in the bevel gear does not normally need to be changed except if repairs are carried out.

Cleaning and lubrication



After you have used the machine clean any resin and plant residue from the blades using cleaning agent 531 00 60-75 (UL22).

Always lubricate the blade bars with special grease, part no. 531 00 60-74 (UL 21) before use.

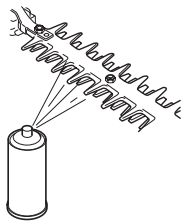

Maintenance schedule

Below you will find some general maintenance instructions. If you need further information please contact your service workshop.

Daily maintenance

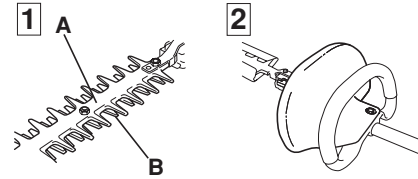

- 1 Check that the blades do not move when the engine is idling or when the choke is in the start throttle position.
- 2 Check that the hand guard is not damaged. Replace the guard if damaged. (HA 110)

Weekly maintenance

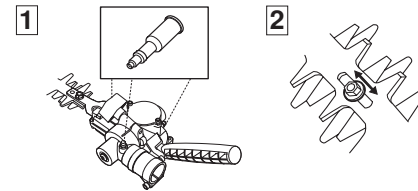

- 1 Fill the gear housing with grease. This should be carried out approximately every 20 working hours.
- 2 Check that the screws that hold the blades together are correctly tightened.

Technical data

Technical data	HA 110	HA 850
Weight		
Weight, Lbs/kg	2,0	2,3
Blades		
Length, mm	550	550
Blade speed, cuts/min	4184	4184