

PTX201D PTX301D

*INSTRUCTIONS FOR USE
MANUEL D'UTILISATION
MANUAL DE INSTRUCCIONES*

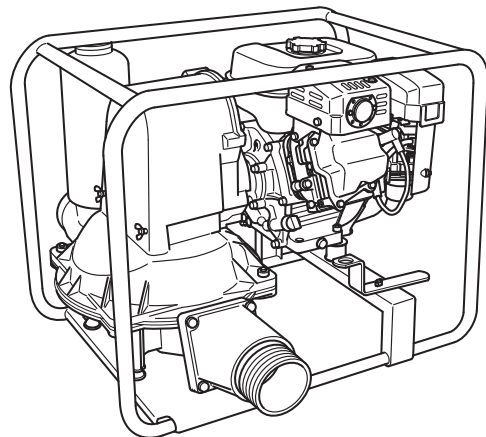

9ZZ9990051



Robin Pump

1

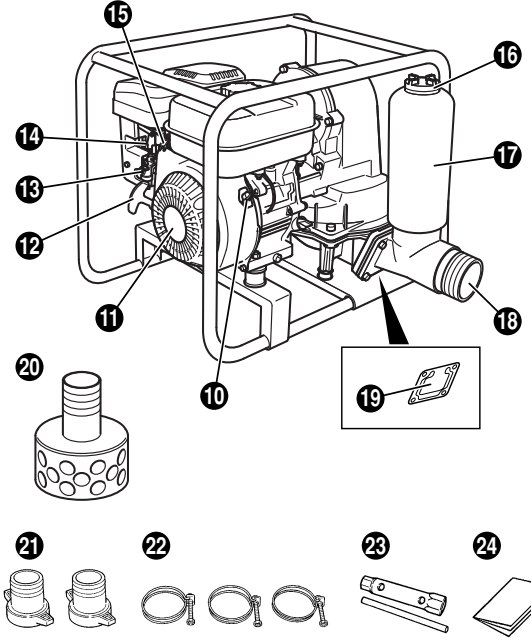
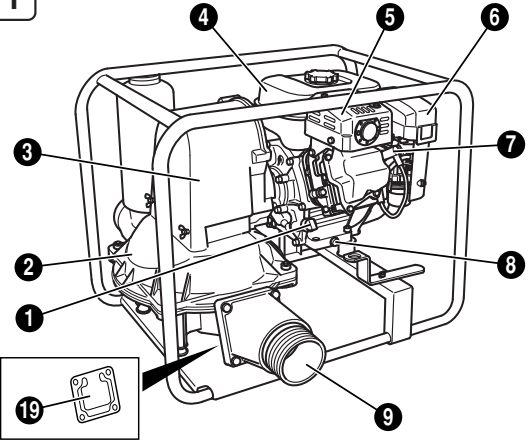

2

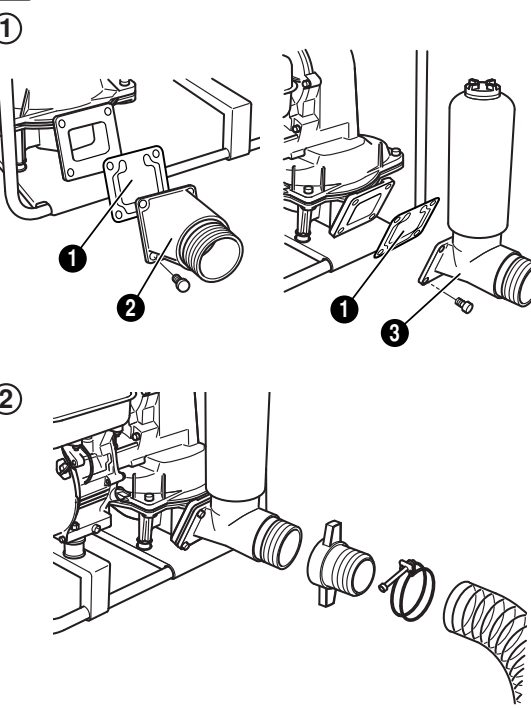

3

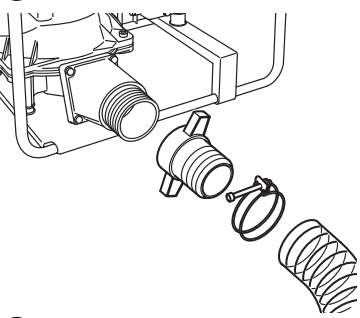

4

Single grade	5W	10W	20W	#20	#30	#40	
	Multi grade						
		10W-30		10W-40			
Ambient temperature	-20	-10	0	10	20	30	40°C
	-4	14	32	50	68	86	104°F

5

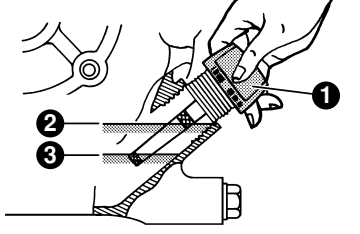

6

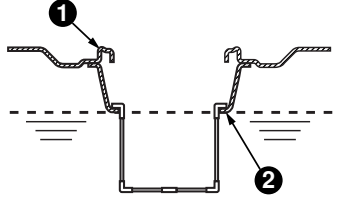

7

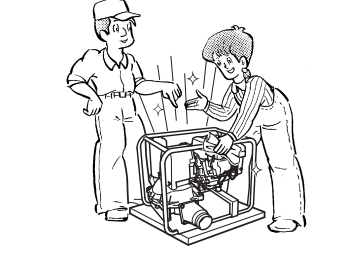

8

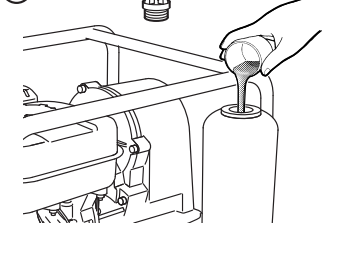

3

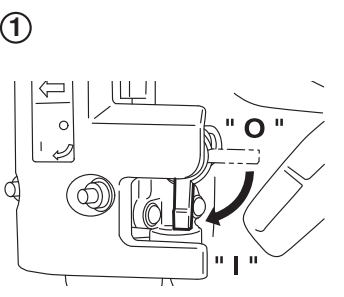

2

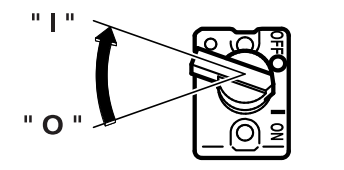

3

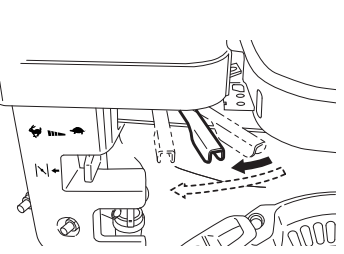

4

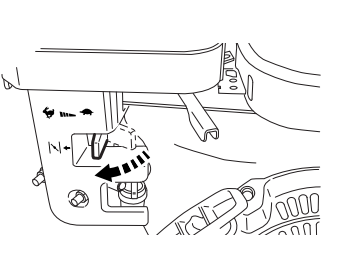

5

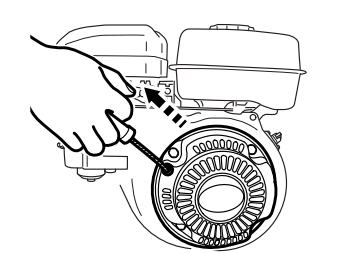

6

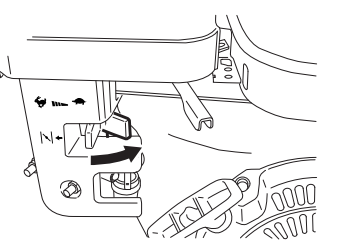

4

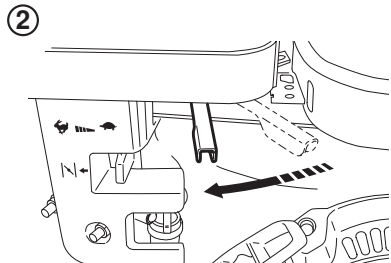
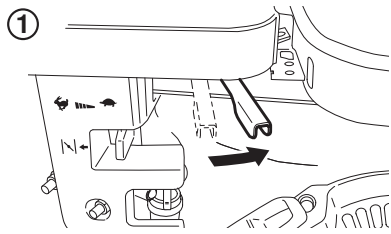

5

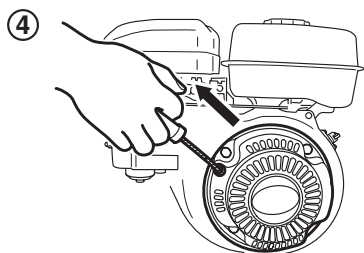
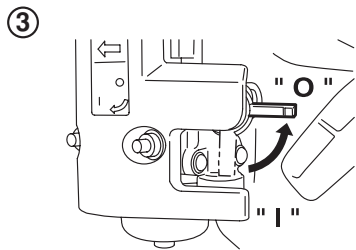
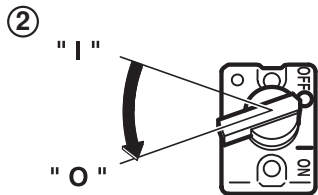
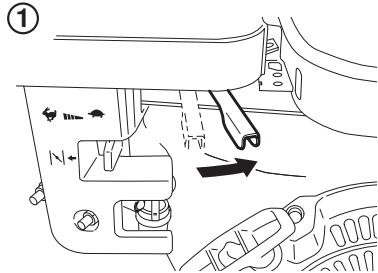

6

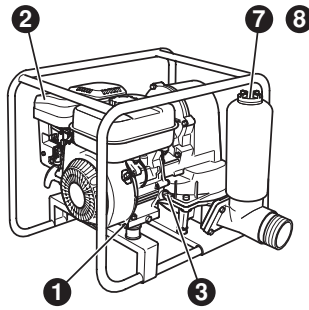
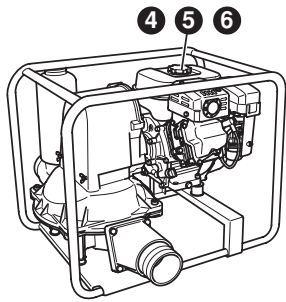

7

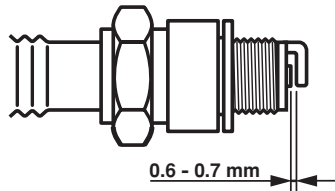

2

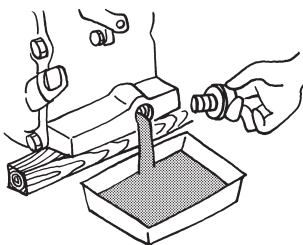

3

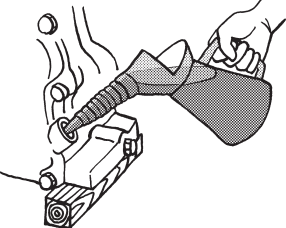

4

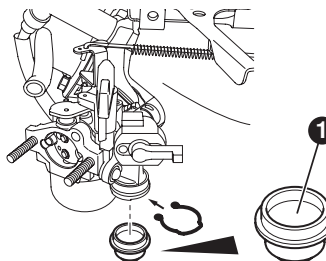

5

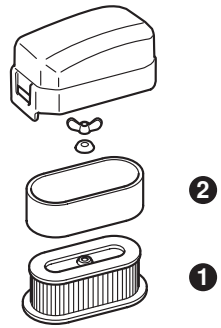

6

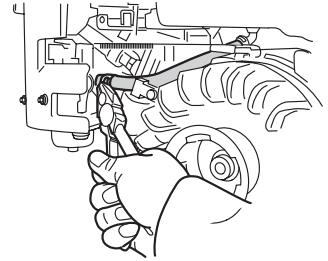

8

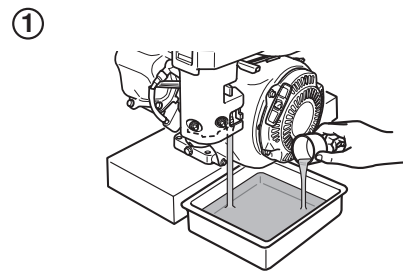

2

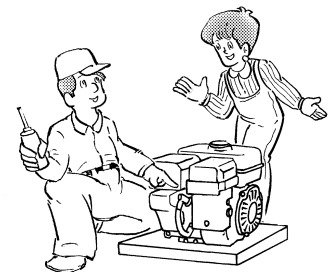

NOTICE

FEDERAL EMISSION COMPONENT DEFECT WARRANTY and CALIFORNIA EMISSION CONTROL WARRANTY are applicable to only those engines/generators complied with EPA (Environmental Protection Agency) and CARB (California Air Resources Board) emission regulations in the U.S.A.

NOTICE

To the engines/generators exported to and used in the countries other than the U.S.A., warranty service shall be performed by the distributor in each country in accordance with the standard Robin engine/generator warranty policy as applicable.

FEDERAL EMISSIONS COMPONENT DEFECT WARRANTY

EMISSIONS COMPONENT DEFECT WARRANTY COVERAGE – This emission warranty is applicable in all States, except the state of California.

Fuji Heavy Industries Ltd. and Robin America Inc., Wood Dale Illinois, (herein “ROBIN AMERICA”) warrant(s) to the initial retail purchaser and each subsequent owner, that this Nonroad engine (herein “engine”) has been designed, built, and equipped to conform at the time of initial sale to all applicable regulations of the U.S.

Environmental Protection Agency (EPA), and that the engine is free of defects in materials and workmanship which would cause this engine to fail to conform with EPA regulations during its warranty period.

For the components listed under PARTS COVERED, the service dealer authorized by ROBIN AMERICA will, at no cost to you, make the necessary diagnosis, repair, or replacement necessary to ensure that the engine complies with applicable U.S. EPA regulations.

EMISSION COMPONENT DEFECT WARRANTY PERIOD

The warranty period for this engine begins on the date of sale to the initial purchaser and continues for a period of two years.

PARTS COVERED

Listed below are the parts covered by the Emission Components Defect Warranty. Some of the parts listed below may require scheduled maintenance and are warranted up to the first scheduled replacement point for that part.

- (1) Fuel Metering System
 - (i) Carburetor and internal parts (and/or pressure regulator or fuel injection system).
 - (ii) Air/fuel ratio feedback and control system, if applicable.
 - (iii) Cold start enrichment system, if applicable.
 - (iv) Regulator assy (gaseous fuel, if applicable)
- (2) Air Induction System
 - (i) Intake manifold, if applicable
 - (ii) Air filter.
- (3) Ignition System
 - (i) Spark plugs.
 - (ii) Magneto or electronic ignition system.
 - (iii) Spark advance/retard system, if applicable.
- (4) Exhaust manifold, if applicable
- (5) Miscellaneous Items Used in Above Systems
 - (i) Electronic controls, if applicable
 - (ii) Hoses, belts, connectors, and assemblies.
 - (iii) Filter lock assy (gaseous fuel, if applicable)

OBTAINING WARRANTY SERVICE

To obtain warranty service, take your engine to the nearest authorized Robin America service dealer . Bring your sales receipts indicating date of purchase for this engine. The service dealer authorized by ROBIN AMERICA will perform the necessary repairs or adjustments within a reasonable amount of time and furnish you with a copy of the repair order. All parts and accessories replaced under this warranty become the property of ROBIN AMERICA.

WHAT IS NOT COVERED

*Conditions resulting from tampering, misuse, improper adjustment (unless they were made by the service dealer authorized by ROBIN AMERICA during a warranty repair), alteration, accident, failure to use the recommended fuel and oil, or not performing required maintenance services.

*The replacement parts used for required maintenance services.

*Consequential damages such as loss of time, inconvenience, loss of use of the engine or equipment, etc.

*Diagnosis and inspection charges that do not result in warranty-eligible service being performed.

*Any non-authorized replacement part, or malfunction of authorized parts due to use of non-authorized parts.

OWNER’S WARRANTY RESPONSIBILITIES

As the engine owner, you are responsible for the performance of the required maintenance listed in your owner’s manual. ROBIN AMERICA recommends that you retain all receipts covering maintenance on your engine, but ROBIN AMERICA cannot deny warranty solely for the lack of receipts or for your failure to ensure the performance of all scheduled maintenance.

As the engine owner, you should however be aware that ROBIN AMERICA may deny warranty coverage if your engine or a part has failed due to abuse, neglect, improper maintenance or unapproved modifications.

You are responsible for presenting your engine to the nearest service dealer authorized by ROBIN AMERICA when a problem exists.

If you have any questions regarding your warranty rights and responsibilities, you should contact the Robin America customer service department at 1-630-350-8200 for the information.

THINGS YOU SHOULD KNOW ABOUT THE EMISSION CONTROL SYSTEM WARRANTY MAINTENANCE AND REPAIRS

You are responsible for the proper maintenance of the engine. You should keep all receipts and maintenance records covering the performance of regular maintenance in the event questions arise. These receipts and maintenance records should be transferred to each subsequent owner of the engine. ROBIN AMERICA reserves the right to deny warranty coverage if the engine has not been properly maintained. Warranty claims will not be denied, however, solely because of the lack of required maintenance or failure to keep maintenance records.

MAINTENANCE, REPLACEMENT OR REPAIR OF EMISSION CONTROL DEVICES AND SYSTEMS MAY BE PERFORMED BY ANY REPAIR ESTABLISHMENT OR INDIVIDUAL; HOWEVER, WARRANTY REPAIRS MUST BE PERFORMED BY A SERVICE DEALER AUTHORIZED BY ROBIN AMERICA. THE USE OF PARTS THAT ARE NOT EQUIVALENT IN PERFORMANCE AND DURABILITY TO AUTHORIZED PARTS MAY IMPAIR THE EFFECTIVENESS OF THE EMISSION CONTROL SYSTEM AND MAY HAVE A BEARING ON THE OUTCOME OF A WARRANTY CLAIM.

If other than the parts authorized by ROBIN AMERICA are used for maintenance replacements or for the repair of components affecting emission control, you should assure yourself that such parts are warranted by their manufacturer to be equivalent to the parts authorized by ROBIN AMERICA in their performance and durability.

HOW TO MAKE A CLAIM

All repair qualifying under this limited warranty must be performed by a service dealer authorized by ROBIN AMERICA. In the event that any emission-related part is found to be defective during the warranty period, you shall notify Robin America customer service department at 1-630-350-8200 and you will be advised of the appropriate warranty service dealer or service providers where the warranty repair can be performed.

FOREWORD

Thank you very much for purchasing a **ROBIN PUMP**.

This manual covers operation and maintenance of **ROBIN PUMP**.

All information in this publication is based on the latest product information available at the time of approval for printing. Please read this manual carefully before operating.

Please take a moment to familiarize yourself with the proper operation and maintenance procedures in order to maximize the safe and efficient use of this product.

Keep this owner's manual at hand, so that you can refer to it at any time.

Due to constant efforts to improve our products, certain procedures and specifications are subjected to change without notice.

When ordering spare parts, always give us the MODEL, PRODUCTION NUMBER and SERIAL NUMBER of your pump.

Please fill in the following blanks after checking the production number on your pump.
(Location of label is different depending on the product specification.)

PROD NO.									

SER NO.				

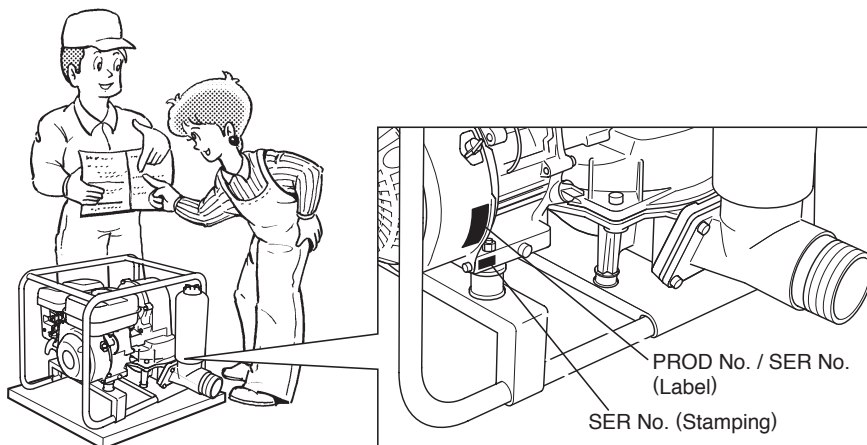

CONTENTS

SAFETY PRECAUTIONS	2
COMPONENTS	4
PRE-OPERATION FOR STARTING	5
OPERATING YOUR PUMP	6
MAINTENANCE	6
PREPARATIONS FOR STORAGE	9
OIL SENSOR INSTRUCTIONS	10
SPARK ARRESTER	10
EASY TROUBLESHOOTING	11
SPECIFICATIONS	12

NOTE Please refer to the illustrations on the back page of the front cover or back cover for Fig. ① to ⑧ indicated in the sentence.

SAFETY PRECAUTIONS

Please make sure you review each precaution carefully.

Pay special attention to statement preceded by the following words.

⚠ WARNING “WARNING” indicates a strong possibility of severe personal injury or loss of life if instructions are not followed.

⚠ CAUTION “CAUTION” indicates a possibility of personal injury or equipment damage if instructions are not followed.

⚠ WARNING : EXHAUST PRECAUTIONS

- Never inhale exhaust gasses.
They contain carbon monoxide, a colorless, odorless and extremely dangerous gas which can cause unconsciousness or death.
- Never operate the pump indoors or in a poorly ventilated area, such as tunnel, cave, etc.
- Exercise extreme care when operating the pump near people or animals.
- Keep the exhaust pipe free of foreign objects.

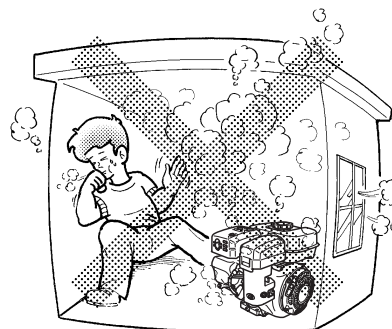

⚠ WARNING : REFUELING PRECAUTIONS

- Fuel is extremely flammable and its vapors can explode if ignited.
- Do not refuel indoors or in a poorly ventilated area.
- Be sure to stop the pump prior to refueling.
- Do not remove fuel tank cap nor fill fuel tank while engine is hot or running. Allow engine to cool at least 2 minutes before refueling.
- Do not overfill the fuel tank.
- If fuel is spilt, wipe it away carefully and wait until the fuel has dried before starting the engine.
- After refueling, make sure that the fuel cap is secured to prevent spillage.

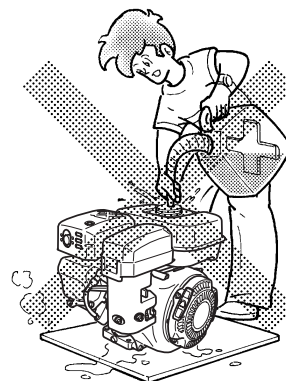

⚠ WARNING : FIRE PREVENTION

- Do not operate the pump while smoking or near an open flame.
- Do not use around dry brush, twigs, cloth rags, or other flammable materials.
- Keep cooling air intake (recoil starter area) and muffler side of the engine at least 1 meter (3 feet) away from buildings, obstructions and other burnable objects.
- Keep the pump away from flammables and other hazardous materials (trash, rags, lubricants, explosives).



⚠ WARNING : OTHER SAFETY PRECAUTIONS

- Be careful of hot parts.
The muffler and other engine parts become very hot while the pump is running or just after it has stopped. Operate the pump in a safe area and keep children away from the running pump.
- Do not use diaphragm pump for the mixture of water and oil.

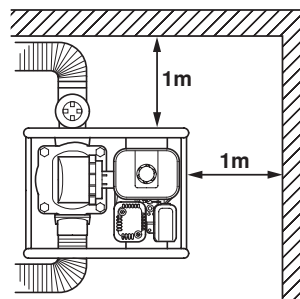

- Do not touch the ignition cable when starting and operating the engine.
- Operate the pump on a stable, level surface.
If the engine is tilted, fuel spillage may result.

NOTE

Operating the pump at a steep incline may cause seizure due to improper lubrication even with a maximum oil level.







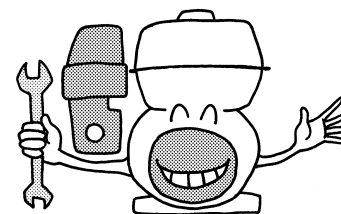
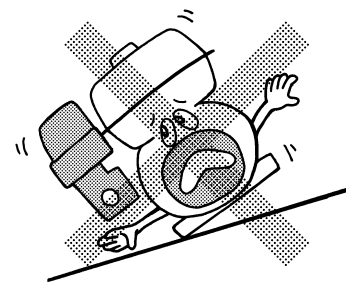





- Do not transport the pump with fuel in tank or with fuel strainer cock open.
- Keep the unit dry (do not operate it in rainy conditions).

⚠ CAUTION : PRE-OPERATION CHECKS

- Carefully check fuel hoses and joints for looseness and fuel leakage.
Leaked fuel creates a potentially dangerous situation.
- Check bolts and nuts for looseness. A loose bolt or nut may cause serious engine trouble.
- Check the engine oil and refill if necessary.
- Check the fuel level and refill if necessary.
Take care not to overfill the tank.
- Keep cylinder fins and recoil starter free of dirt, grass and other debris.
- Wear snug fitting working clothes when operating the engine.
Loose aprons, towels, belt, etc., may be caught in the engine or drive train, causing a dangerous situation.



SYMBOLS

	Read the owner's manual.		
	Stay clear of the hot surface.		
	Exhaust gas is poisonous. Do not operate in an unventilated area.		
	Stop the engine before refueling.		
	Fire, open flame and smoking prohibited.		
	On (Run)		Plus ; Positive polarity
	Off (Stop)		Battery
	Engine oil		Engine start (Electric start)
	Add oil		

COMPONENTS

(See Fig. 1)

NOTE Please refer to the illustrations on the back page of the front cover or back cover for Fig. 1 to 8 indicated in the sentence.

- | | | |
|-------------------------------|-------------------------|---|
| ① Oil filler (with Oil gauge) | ⑨ Delivery | ⑰ Suction chamber |
| ② Pump body | ⑩ Stop switch | ⑱ Suction |
| ③ Gear case | ⑪ Recoil starter | ⑲ Check valves |
| ④ Fuel tank | ⑫ Recoil starter handle | ⑳ Strainer |
| ⑤ Muffler | ⑬ Fuel cock | ㉑ Hose coupling |
| ⑥ Air cleaner | ⑭ Choke lever | ㉒ Hose band |
| ⑦ Spark plug | ⑮ Speed control lever | ㉓ Tools |
| ⑧ Drain plug (at two places) | ⑯ Plug (filler) | ㉔ Instruction for use
(This publication) |

PRE-OPERATION FOR STARTING

(See Fig. ②)

1. ATTACH THE FLANGE AND CHECK VALVES (See Fig. ②-①)

Attach the suction flange, delivery flange and check valves to the pump when operating the brand new pump for the first time.

- ① Check valves
- ② Delivery
- ③ Suction

⚠ CAUTION

Be careful not to overtighten the bolts.
 Suction flange tightening torque : 90-120 kg-cm
 Delivery flange tightening torque : 90-120 kg-cm

2. CONNECT SUCTION HOSE (See Fig. ②-②)

Use a reinforced-wall or wire braided hose to prevent suction collapse.

Since the pump self-priming time is directly proportional to hose length, a short hose is recommended.

⚠ CAUTION

Always use a strainer with the suction hose. Gravel or debris sucked into the pump will cause serious damage to the impeller and the pump casting.

3. CONNECT DELIVERY HOSE (See Fig. ②-③)

When using a fabric hose, always use a hose band to prevent the hose from disconnecting under high pressure.

4. CHECK ENGINE OIL (See Fig. ②-⑤)

Before checking or refilling engine oil, be sure the engine is located on stable, level surface and stopped.

- Do not screw the oil gauge into the oil filler neck to check oil level. If the oil level is low, refill to the upper level with the following recommended oil.
- Use 4-stroke automotive detergent oil of API service class SE or higher grade (SG, SH or SJ is recommended).

- Select the viscosity based on the air temperature at the time of operation as shown in the table. (See Fig. ②-④)

Explanation of Fig. ②-⑤

- ① Oil Gauge
- ② Upper Level
- ③ Lower Level

Oil capacity (Upper level) : L (U.S. gal)

PTX201D/301D 0.6 (0.16)

5. CHECK FUEL (See Fig. ②-⑥)

⚠ WARNING

Do not refuel while smoking, near an open flame or other such potential fire hazards. Otherwise fire accident may occur.

- Stop the engine and open the cap.
- Use automotive unleaded gasoline only. This engine is certified to operate on automotive unleaded gasoline. Fuel Tank Capacity Refer to "SPECIFICATIONS" Page 12 for fuel tank capacity
- Close the fuel cock before filling the fuel tank.
- Do not fill above the top of the fuel filter screen (marked ②), or the fuel may overflow when it heats up later and expands.
- When filling the fuel tank, always use the fuel filter screen.
- Wipe off any spilled fuel before starting the engine. (See Fig. ②-⑦)

6. CHECK PRIMING WATER (See Fig. ②-⑧)

It is recommended that the water chamber of pump casing should be primed with full of water before operating.

⚠ WARNING

Never attempt to operate the pump without priming water or the pump will overheat. Extended dry operation will destroy the mechanical seal. If the unit has been operated dry, stop the engine immediately and allow the pump to cool before adding priming water.

OPERATING YOUR PUMP

1. STARTING (See Fig. 3)

- (1) Open the fuel cock. (See Fig. 3-1)
- (2) Turn the STOP SWITCH to the position "I" (ON). (See Fig. 3-2)
- (3) Set the speed control lever 1/3 of the way towards the high speed position. (See Fig. 3-3)
- (4) Close the choke lever. (See Fig. 3-4)
 - If the engine is cold or the ambient temperature is low, close the choke lever fully.
 - If the engine is warm or the ambient temperature is high, open the choke lever half-way, or keep it fully open.
- (5) Pull the starter handle slowly until resistance is felt. This is the "compression" point. Return the handle to its original position and pull swiftly. Do not pull out the rope all the way. After starting the engine, allow the starter handle to return to its original position while still holding the handle. (See Fig. 3-5)
- (6) After starting the engine, gradually open choke by turning the choke lever and finally keep it fully opened. Do not fully open the choke lever immediately when the engine is cold or the ambient temperature is low, because the engine may stop. (See Fig. 3-6)

2. RUNNING (See Fig. 4)

- (1) After the engine starts, set the speed control lever at the low speed position (L) and warm it up without load for a few minutes. (See Fig. 4-1)
- (2) Gradually move the speed control lever toward the high speed position (H) and set it at the required engine speed. (See Fig. 4-2)
 - Whenever high speed operation is not required, slow the engine down (idle) by moving the speed control lever to save fuel and extend engine life.

3. STOPPING (See Fig. 5)

- (1) Set the speed control lever at the low speed position and allow the engine to run at low speed for 1 or 2 minutes before stopping. (See Fig. 5-1)
- (2) Turn the STOP SWITCH counterclockwise to the position "O" (OFF). (See Fig. 5-2)
- (3) Close the fuel cock. (See Fig. 5-3)
- (4) Pull the starter handle slowly and return the handle to its original position when resistance is felt. This operation is necessary to prevent outside moist air from intruding into the combustion chamber. (See Fig. 5-4)

※STOPPING ENGINE WITH THE FUEL COCK

Close the fuel cock and wait for a while until the engine stops. Avoid to let the fuel remain in the carburetor over long periods, or the passages of the carburetor may become clogged with impurities, and malfunctions may result.

MAINTENANCE

(See Fig. 6)

1. DAILY INSPECTION

Before running the engine, check the following service items.

- ① Loose or broken bolts and nuts
- ② Clean air cleaner element
- ③ Enough clean engine oil
- ④ Leakage of gasoline and engine oil
- ⑤ Enough gasoline
- ⑥ Safe surroundings
- ⑦ Check the priming water
- ⑧ Excessive vibration, noise

2. PERIODIC INSPECTION

Periodic maintenance is vital to the safe and efficient operation of your pump.

Check the table below for periodic maintenance intervals.

IT IS ALSO NECESSARY FOR THE USER OF THIS PUMP TO CONDUCT THE MAINTENANCE AND ADJUSTMENTS ON THE EMISSION-RELATED PARTS LISTED BELOW TO KEEP THE EMISSION CONTROL SYSTEM EFFECTIVE.

The emission control system consists of the following parts :

- (1) Carburetor and internal parts
- (2) Cold start enrichment system, if applicable
- (3) Intake manifold, if applicable
- (4) Air cleaner elements
- (5) Spark plug

- (6) Magneto or electronic ignition system
- (7) Spark advance/ retard system, if applicable
- (8) Exhaust manifold, if applicable.
- (9) Hoses, belts, connectors, and assemblies

The maintenance schedule indicated in the following table is based on the normal engine operation.

Should the engine be operated in extremely dusty condition or in heavier loading condition, the maintenance intervals must be shortened depending on the contamination of oil, clogging of filter elements, wear of parts, and so on.

⚠ CAUTION

Replace rubber pipes for fuel passage every two years. If fuel leakage is found, replace the pipe immediately.

Periodic Maintenance Schedule table

Maintenance Items	Every 8 hours (Daily)	Every 50 hours (Weekly)	Every 200 hours (Monthly)	Every 500 hours	Every 1000 hours
Clean pump set and check bolt and nuts	● (Daily)				
Check and refill engine oil	● (Refill daily up to upper level)				
Change engine oil (*Note 1)	● (Initial 20 hours)	● (Every 100 hours)			
Clean spark plug		● (Every 100 hours)			
Clean air cleaner		●			
Lubricate the pump-rod bearing		●			
Clean spark arrester (Optional part)		● (Every 100 hours)			
Replace air cleaner element			●		
Clean fuel cup			●		
Clean and adjust spark plug and electrodes			●		
Replace spark plug				●	
Remove carbon from cylinder head (*Note 2)				●	
Check and adjust valve clearance (*Note 2)				●	
Clean and adjust carburetor (*Note 2)				●	
Check and refill gear box grease				●	
Check suction and delivery check valves				●	
Replace fuel lines					● (Yearly)
Overhaul engine if necessary (*Note 2)					●

*Note 1: Initial oil change should be performed after first twenty (20) hours of operation. Thereafter change oil every hundred (100) hours. Before changing oil, check for a suitable way to dispose of old oil. Do not pour it down into sewage drains, onto garden soil or into open streams. Your local zoning or environmental regulations will give you more detailed instructions on proper disposal.

*Note 2: As to the procedures for these items, please refer to the SERVICE MANUAL or consult your nearest service dealer.

3. INSPECTING THE SPARK PLUG (See Fig. 7-①)

- (1) Clean off carbon deposits on the spark plug electrode using a plug cleaner or wire brush.
- (2) Check electrode gap. The gap should be 0.6 mm to 0.7 mm (0.02 inch.-0.03 inch.). Adjust the gap, if necessary, by carefully bending the side electrode.

Recommended Spark Plug : NGK BR-6HS
(CHAMPION RL86C)

4. ENGINE OIL CHANGE (See Fig. 7-②,③)

Initial oil change : After 20 hours of operation

Thereafter : Every 100 hours of operation

- (1) When changing oil, stop the engine and loosen the drain plug. Drain the used oil while the engine is warm. Warm oil drains quickly and completely.

⚠ CAUTION

To prevent injury, pay attention to the hot oil. Make sure the fuel cap is tightly secured to avoid spillage.

- (2) Re-install the drain plug before refilling oil.

Oil capacity (Upper level) : L (U.S. gal)

PTX201D/301D 0.6 (0.16)

- (3) Refer to page 5 for the recommended oil.
 - Always use the best grade and clean oil. Contaminated oil, poor quality oil and shortage of oil cause damage to engine or shorten the engine life.

5. CLEANING FUEL CUP (See Fig. 7-④)

⚠ WARNING Flame Prohibited

- (1) Inspect fuel cup for water and dirt.
(See Fig. 7-④-①)
- (2) To remove water and dirt, close the fuel cock and remove the fuel cup.
- (3) After removing dirt and water, wash the fuel cup with kerosene or gasoline. Reinstall securely to prevent leakage.

6. CLEANING AIR CLEANER (See Fig. 7-⑤,⑥)

A dirty air cleaner element will cause starting difficulty, power loss, engine malfunctions, and shorten engine life extremely.

Always keep the air cleaner element clean.

⚠ WARNING Flame Prohibited

Urethane Foam Dual Element Type

(See Fig. 7-⑤)

- Urethane Foam cleaning (See Fig. 7-⑤-②)
Wash and clean the urethane foam with detergent. After cleaning, dry it. Clean the urethane foam element every 50 hours.
- Second element (See Fig. 7-⑤-①)
Clean by tapping gently to remove dirt and blow off dust. Never use oil. Clean the paper element every 50 hours of operation, and replace element set every 200 hours.

Clean and replace air cleaner elements more often when operating in dusty environments.

7. FUEL HOSE REPLACEMENT

(See Fig. 7-6)

⚠ WARNING

Take extreme caution when replacing fuel hose ; gasoline is extremely flammable.

Replace the fuel hose every 1,000 hours or every year.

If fuel leaks from fuel hose, replace the fuel hose immediately.

8. CHECKING BOLTS, NUTS AND SCREWS

- Retighten loose bolts and nuts.
- Check for fuel and oil leaks.
- Replace damaged parts with new ones.

PREPARATIONS FOR STORAGE

1. DISCONNECT THE DELIVERY HOSE

Tilt the pump and drain all water from delivery hole. Severe damage to pump may result if water freezes in the pumping chamber.

2. DISCHARGE FUEL(See Fig. 8-1)

⚠ WARNING Flame Prohibited

If you do not use the engine more than 1 month, discharge fuel to prevent gum in the fuel system and carburetor parts.

- Remove the strainer cup, place the strainer over a container and open the strainer cock to discharge fuel from the fuel tank.
- Remove the drain screw of the carburetor float chamber and discharge fuel.

3. ENGINE OIL (See Fig. 8-2)

- Change the engine oil with fresh oil.
- Remove the spark plug, pour about 5 cc of engine oil into the cylinder, slowly pull the starter handle of the recoil starter 2 or 3 times, and reinstall the spark plug.

4. CLEAN AND STORE

- Slowly pull the recoil starter handle until resistance is felt and leave it in that position.
- Clean the pump thoroughly with an oiled cloth, put the cover on, and store the pump indoors in a well ventilated, low humidity area.

OIL SENSOR INSTRUCTIONS

1. FUNCTION OF OIL SENSOR

The engine will stop automatically when the oil level falls below the safety limit. The engine cannot be started unless the level is raised above the prescribed limit.

(See Fig. 2-5)

2. RESTARTING

- (1) Fill the crankcase with oil up to the proper level.
 - (2) As for restarting and operating the engine, refer to section “**OPERATING YOUR PUMP**” on page 6.
- Check the wire connector from the engine. It must be connected securely to the wire from oil sensor.
 - When selecting the engine oil, refer to page 5 for the recommended oil.

SPARK ARRESTER

In a dry or wooded area, it is recommendable to use the product with a spark arrester. Some areas require the use of a spark arrester. Please check your local laws and regulations before operating your product.

The spark arrester must be cleaned regularly to keep it functioning as designed. A clogged spark arrester:

- Prevents the flow of exhaust gas
- Reduces engine output
- Increases fuel consumption
- Makes starting difficult

If the engine has been running, the muffler and the spark arrester will be very hot. Allow the muffler to cool before cleaning the spark arrester.

How to remove the spark arrester

1. Remove the flange bolts from the muffler cover and remove the muffler cover.
2. Remove the special screw from the spark arrester and remove the spark arrester from the muffler.

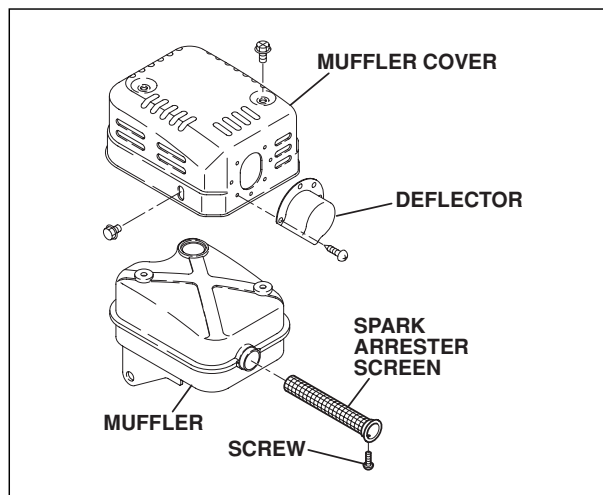

Clean the spark arrester screen

Use a brush to remove carbon deposits from the spark arrester screen. Be careful to avoid damaging the screen.

The spark arrester must be free of breaks and holes. Replace the spark arrester if it is damaged.

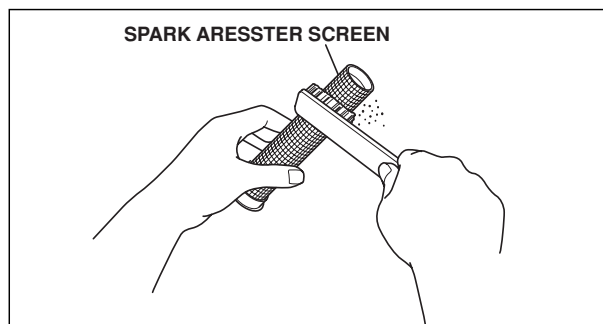

Install the spark arrester, and muffler protector in the reverse order of disassembly.

EASY TROUBLESHOOTING

1. PUMP DOES NOT RUN.

- Engine dose not start.
(See “WHEN ENGINE DOES NOT START”)
- Solid object preventing pump-rod from completing stroke. (Disassemble and clean.)

2. PUMPING VOLUME IS SMALL.

- Sucking air at suction side.
(Check piping at suction side.)
- Drop off engine output
(Consult your nearest dealer.)
- Debris keeping check valve open.
(Disassemble and clean.)
- High suction lift (Lower.)
- Suction hose is too long or thin.
(Use a thick hose in minimum length.)
- Leak of water from water passage.
(Stop leaking.)
- Breakage of rubber diaphragm.
(Consult your nearest dealer)
- Looseness of suction chamber.
(Retighten)
- Strainer is clogged. (Clean.)
- Engine speed is too low.
(Consult your nearest dealer.)

3. DELIVERY HOSE DOES NOT STAY ON COUPLING.

- Hose may be kinked or discharge end may be blocked or clogged. (Straighten or clean.)

4. PUMP SUDDENLY STOPS.

- Solid object preventing pump-rod from completing stroke. (Disassemble and clean.)

5. WHEN ENGINE DOES NOT START :

Perform the following checks before you take the pump to your Robin dealer. If you still have trouble after completing the checks, take the pump to your nearest Robin dealer.

(1) Is there a strong spark across the electrode ?

- Is the stop switch at position “ I ” (ON)?
- Remove and inspect the spark plug.
If the electrode is fouled, clean or replace it with new one.
- Remove the spark plug and connect it to the plug cap. Pull the starter handle while grounding spark plug against engine body. Try with a new spark plug if the spark is weak or there is no spark.
The ignition system is faulty if there is no spark with a new spark plug.

⚠ WARNING

- **Wipe out spilled fuel carefully before testing. Place spark plug as far away from spark plug hole as possible.**
- **Do not hold spark plug by hand while pulling recoil starter.**

NOTE

The engine with oil sensor will stop automatically when the oil level falls below the prescribed limit. Unless the oil level is raised above the prescribed limit, the engine will stop immediately after starting.

(2) Is there enough compression?

Pull the starter handle slowly and check if resistance is felt. If little force is required to pull the starter handle, check if the spark plug is tightened firmly. If the spark plug is loose, tighten it.

(3) Is the spark plug wet with gasoline?

- Is the fuel cock opened?
- Choke (close choke lever) and pull the starter handle five or six times. Remove the plug and check if its electrode is wet. If the electrode is wet, fuel is well supplied to your engine.
- When the electrode is dry, check where the fuel stops.
(Check the fuel intake of the carburetor.)
- In case the engine does not start with well supplied fuel, try using fresh fuel.

SPECIFICATIONS

MODEL		PTX201D	PTX301D
PUMP	Type	Self-priming, Diaphragm pump	
	Suction x Delivery Diameters mm (in.)	50.8 × 50.8 (2×2)	76.2 × 76.2 (3×3)
	Total Head m (ft)	15 (49)	
	Maximum Delivery Volume Liter(U.S.gal)/min	125 (33)	250 (66)
	Suction Head m (ft)	7.6 (25)	
ENGINE	Model	EX13	EX17
	Type	Air - Cooled, 4 - cycle, OHC, Gasoline Engine	
	Fuel	Automotive unleaded gasoline	
	Fuel Tank Capacity Liter (U.S.gal)	2.7 (0.7)	3.6 (0.95)
	Lubricant	Automotive detergent oil (API / SE or higher grade, SG, SH or SJ is recommended. SEA / 10W-30 etc.	
	Lubricating Oil capacity Liter (U.S.gal)	0.6 (0.16)	
	Spark Plug	NGK BR-6HS (CHAMPION RL86C)	
	Starting system	Reciol starter	
Dimensions (L x W x H) mm (in.)	614 × 370 × 510 (24.2 × 14.6 × 20.1)	660 × 420 × 510 (26.0 × 16.5 × 20.1)	
Dry weight kg (lb)	38 (83.8)	45 (99.2)	
Standard accessories	Engine tool kit (1 set), Strainer (1pc.),Hose band (3pcs.),Hose coupling (2pcs.)		
Valve Clearance (Intake and Exhaust)	0.12 ^{+0.03} ₀ mm (0.0047 ^{+0.0012} ₀ in.)		
Note : Adjust the valve clearance while the engine is cold.			

ISSUE EMD-PU2365



SUBARU

**FUJI HEAVY INDUSTRIES LTD.
INDUSTRIAL PRODUCTS COMPANY**

4-410 ASAHI, KITAMOTO-SHI, SAITAMA, 364-8511, JAPAN
TEL:+81-48-593-7798, FAX:+81-48-593-7946
<http://www.fhi.co.jp/robin/>

PRINTED IN JAPAN
May 2007