



Bobcat®

Service Manual



S70

Skid-Steer Loader

S/N A3W611001 & Above
S/N A3W711001 & Above
S/N B38V11001 & Above
S/N B38W11001 & Above
S/N B4TY11001 & Above
S/N B4UC11001 & Above



MAINTENANCE SAFETY



WARNING

Instructions are necessary before operating or servicing machine. Read and understand the Operation & Maintenance Manual, Operator's Handbook and signs (decals) on machine. Follow warnings and instructions in the manuals when making repairs, adjustments or servicing. Check for correct function after adjustments, repairs or service. Untrained operators and failure to follow instructions can cause injury or death.

W-2003-0807



Safety Alert Symbol: This symbol with a warning statement, means: "Warning, be alert! Your safety is involved!" Carefully read the message that follows.

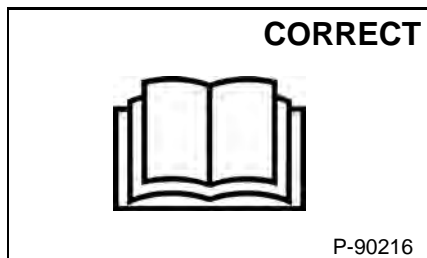

P-90216

⚠ Never service the Bobcat Skid-Steer Loader without instructions.

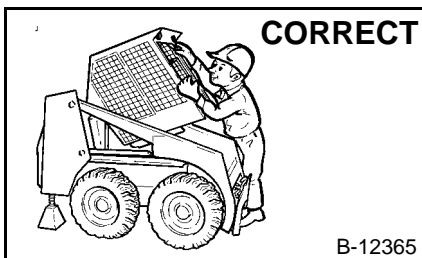

B-12365

⚠ Use the correct procedure to lift or lower operator cab.

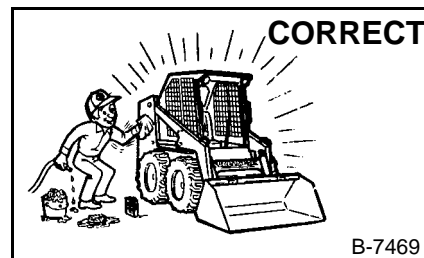

B-7469

⚠ Cleaning and maintenance are required daily.

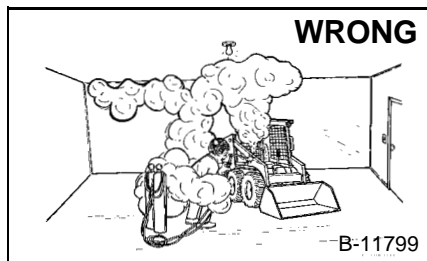

B-11799

- ⚠ Have good ventilation when welding or grinding painted parts.
- ⚠ Wear dust mask when grinding painted parts. Toxic dust and gas can be produced.
- ⚠ Avoid exhaust fume leaks which can kill without warning. Exhaust system must be tightly sealed.

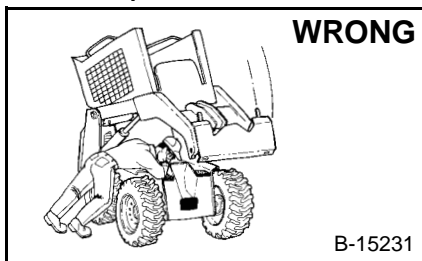

B-15231

⚠ Disconnecting or loosening any hydraulic tubeline, hose, fitting, component or a part failure can cause lift arms to drop. Do not go under lift arms when raised unless supported by an approved lift arm support device. Replace it if damaged.

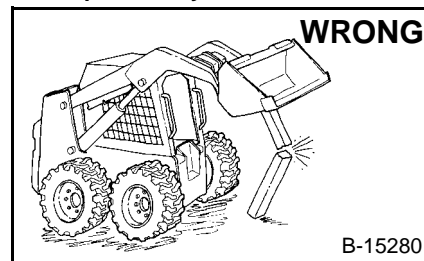

B-15280

- ⚠ Never work on loader with lift arms up unless lift arms are held by an approved lift arm support device. Replace if damaged.
- ⚠ Never modify equipment or add attachments not approved by Bobcat Company.

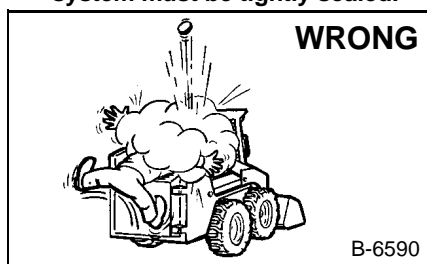

B-6590

- ⚠ Stop, cool and clean engine of flammable materials before checking fluids.
- ⚠ Never service or adjust loader with the engine running unless instructed to do so in the manual.
- ⚠ Avoid contact with leaking hydraulic fluid or diesel fuel under pressure. It can penetrate the skin or eyes.
- ⚠ Never fill fuel tank with engine running, while smoking or when near open flame.

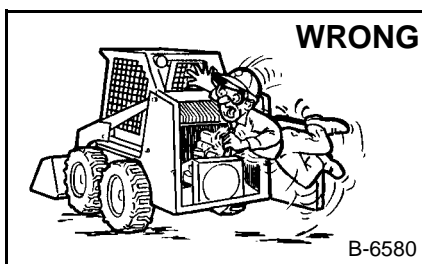

B-6580

- ⚠ Keep body, jewelry and clothing away from moving parts, electrical contact, hot parts and exhaust.
- ⚠ Wear eye protection to guard from battery acid, compressed springs, fluids under pressure and flying debris when engines are running or tools are used. Use eye protection approved for type of welding.
- ⚠ Keep rear door closed except for service. Close and latch door before operating the loader.



B-6589

- ⚠ Lead-acid batteries produce flammable and explosive gases.
- ⚠ Keep arcs, sparks, flames and lighted tobacco away from batteries.
- ⚠ Batteries contain acid which burns eyes or skin on contact. Wear protective clothing. If acid contacts body, flush well with water. For eye contact flush well and get immediate medical attention.

Maintenance procedures which are given in the Operation & Maintenance Manual can be performed by the owner/operator without any specific technical training. Maintenance procedures which are **not** in the Operation & Maintenance Manual must be performed **ONLY BY QUALIFIED BOBCAT SERVICE PERSONNEL**. Always use genuine Bobcat replacement parts. The Service Safety Training Course is available from your Bobcat dealer.

MSW01-0409



Bobcat®

CONTENTS

SAFETY AND MAINTENANCE	10-01
HYDRAULIC SYSTEM	20-01
HYDROSTATIC SYSTEM	30-01
DRIVE SYSTEM	40-01
MAINFRAME	50-01
ELECTRICAL SYSTEM AND ANALYSIS	60-01
ENGINE SERVICE	70-01
HEATER	80-01
SPECIFICATIONS	SPEC-01
ALPHABETICAL INDEX	INDEX-01



Bobcat®

FOREWORD

FOREWORD	1-7
SAFETY INSTRUCTIONS	1-9
FIRE PREVENTION	1-11
Maintenance	1-11
Operation	1-11
Electrical	1-11
Hydraulic System	1-11
Fueling	1-11
Starting	1-11
Spark Arrester Exhaust System	1-11
Welding And Grinding	1-12
Fire Extinguishers	1-12
SERIAL NUMBER LOCATIONS	1-13
Loader Serial Number	1-13
Engine Serial Number	1-13
DELIVERY REPORT	1-14
LOADER IDENTIFICATION	1-15



Bobcat®

FOREWORD

This manual is for the Bobcat loader mechanic. It provides necessary servicing and adjustment procedures for the Bobcat loader and its component parts and systems. Refer to the Operation & Maintenance Manual for operating instructions, starting procedure, daily checks, etc.

A general inspection of the following items must be made after the loader has had service or repair:

1. Check that the ROPS/FOPS (Including side screens) is in good condition and is not modified.

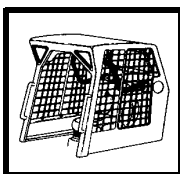

2. Check that ROPS mounting hardware is tightened and is Bobcat approved.

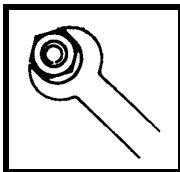

3. The seat belt must be correctly installed, functional and in good condition.

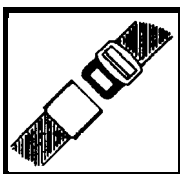

4. The seat bar must be correctly adjusted, clean and lubricated.

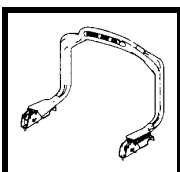

5. Check lift arm support device, replace if damaged.



6. Machine signs (decals) must be legible and in the correct location.



7. Steering levers, hand controls and foot pedals must return to neutral (as applicable).

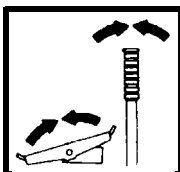

8. Check for correct function of the work lights.



9. The parking brake must function correctly.

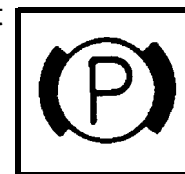

10. Enclosure door latches must open and close freely.

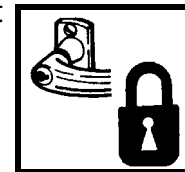

11. Bob-Tach® attachment mounting system wedges and linkages must function correctly and be in good condition.

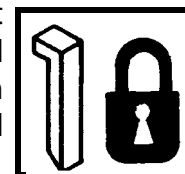

12. Safety treads must be in good condition.



13. Check for correct function of indicator lamps.

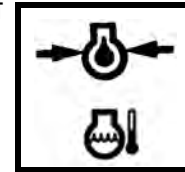

14. Check all machine fluid levels.

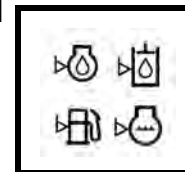

15. Inspect for fuel, oil or hydraulic fluid leaks.

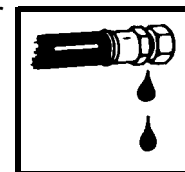

16. Lubricate the loader.



FW SSL-0119 SM

17. Check the condition of the battery and cables.

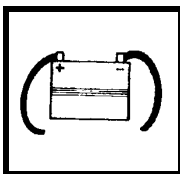

18. Inspect the air cleaner for damage or leaks. Check the condition of the element.

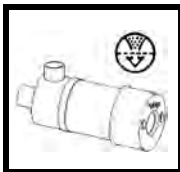

19. Check the electrical charging system.

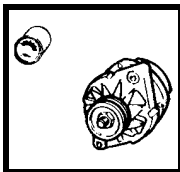

20. Check tires for wear and pressure. Check tracks for wear and tension. Use only approved tires or tracks.

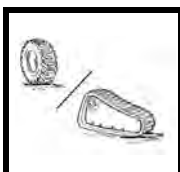

21. Inspect for loose or broken parts or connections.



22. Check for any field modification not completed.



23. Operate the machine and check all functions.



24. Check for correct function of the Bobcat Interlock Control System (BICS™) before the machine is returned to the customer.



25. Check for proper function of front horn and back-up alarm (if equipped).

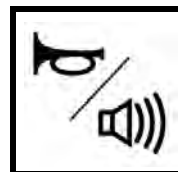

26. Check function or condition of all equipped options and accessories (examples: fire extinguisher, rotating beacon, lift kits, etc.).



27. Recommend to the owner that all necessary corrections be made before the machine is returned to service.

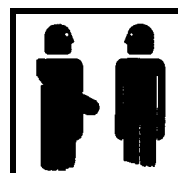

SAFETY INSTRUCTIONS



Safety Alert Symbol

This symbol with a warning statement means: "Warning, be alert! Your safety is involved!" Carefully read the message that follows.



WARNING

AVOID INJURY OR DEATH

Instructions are necessary before operating or servicing machine. Read and understand the Operation & Maintenance Manual, Operator's Handbook and signs (decals) on machine. Follow warnings and instructions in the manuals when making repairs, adjustments or servicing. Check for correct function after adjustments, repairs or service. Untrained operators and failure to follow instructions can cause injury or death.

W-2003-0807

IMPORTANT

This notice identifies procedures which must be followed to avoid damage to the machine.

I-2019-0284



DANGER

The signal word DANGER on the machine and in the manuals indicates a hazardous situation which, if not avoided, will result in death or serious injury.

D-1002-1107



WARNING

The signal word WARNING on the machine and in the manuals indicates a potentially hazardous situation which, if not avoided, could result in death or serious injury.

W-2044-1107

The following publications provide information on the safe use and maintenance of the Bobcat machine and attachments:

- The Delivery Report is used to assure that complete instructions have been given to the new owner and that the machine is in safe operating condition.
- The Operation & Maintenance Manual delivered with the machine or attachment contains operating information as well as routine maintenance and service procedures. It is a part of the machine and can be stored in a container provided on the machine. Replacement Operation & Maintenance Manuals can be ordered from your Bobcat dealer.
- Machine signs (decals) instruct on the safe operation and care of your Bobcat machine or attachment. The signs and their locations are shown in the Operation & Maintenance Manual. Replacement signs are available from your Bobcat dealer.
- An Operator's Handbook fastened to the operator cab. It's brief instructions are convenient to the operator. The handbook is available from your dealer in an English edition or one of many other languages. See your Bobcat dealer for more information on translated versions.
- The AEM Safety Manual delivered with the machine gives general safety information.
- The Service Manual and Parts Manual are available from your dealer for use by mechanics to do shop-type service and repair work.
- The Skid-Steer Loader Operator Training Course is available through your local dealer or at **Bobcat.com/training** or **Bobcat.com**. This course is intended to provide rules and practices of correct operation of the skid-steer loader. The course is available in English and Spanish versions.
- Service Safety Training Courses are available from your Bobcat dealer or at **Bobcat.com/training** or **Bobcat.com**. They provide information for safe and correct service procedures.
- The Skid-Steer Loader Safety Video is available from your Bobcat dealer or at **Bobcat.com/training** or **Bobcat.com**.

SI SSL-1016 SM

SAFETY INSTRUCTIONS (CONT'D)

The dealer and owner / operator review the recommended uses of the product when delivered. If the owner / operator will be using the machine for a different application(s) he or she must ask the dealer for recommendations on the new use.



Cutting or drilling concrete containing sand or rock containing quartz may result in exposure to silica dust. Do not exceed Permissible Exposure Limits (PEL) to silica dust as determined by OSHA or other job site Rules and Regulations. Use a respirator, water spray or other means to control dust. Silica dust can cause lung disease and is known to the state of California to cause cancer.

Call Before You Dig
Dial 811 (USA Only)
1-888-258-0808 (USA & Canada)

When you call, you will be directed to a location in your state / province, or city for information about buried lines (telephone, cable TV, water, sewer, gas, etc.).

FIRE PREVENTION



Maintenance

The machine and some attachments have components that are at high temperatures under normal operating conditions. The primary source of high temperatures is the engine and exhaust system. The electrical system, if damaged or incorrectly maintained, can be a source of arcs or sparks.

Flammable debris (leaves, straw, etc.) must be removed regularly. If flammable debris is allowed to accumulate, it can cause a fire hazard. Clean often to avoid this accumulation. Flammable debris in the engine compartment is a potential fire hazard.

The operator's area, engine compartment and engine cooling system must be inspected every day and cleaned if necessary to prevent fire hazards and overheating.

All fuels, most lubricants and some coolants mixtures are flammable. Flammable fluids that are leaking or spilled onto hot surfaces or onto electrical components can cause a fire.

Operation

Do not use the machine where exhaust, arcs, sparks or hot components can contact flammable material, explosive dust or gases.

Electrical



Check all electrical wiring and connections for damage. Keep the battery terminals clean and tight. Repair or replace any damaged part or wires that are loose or frayed.

Battery gas can explode and cause serious injury. Use the procedure in the Operation & Maintenance Manual for connecting the battery and for jump starting. Do not jump start or charge a frozen or damaged battery. Keep any open flames or sparks away from batteries. Do not smoke in battery charging area.

Hydraulic System

Check hydraulic tubes, hoses and fittings for damage and leakage. Never use open flame or bare skin to check for leaks. Hydraulic tubes and hoses must be properly routed and have adequate support and secure clamps. Tighten or replace any parts that show leakage.

Always clean fluid spills. Do not use gasoline or diesel fuel for cleaning parts. Use commercial nonflammable solvents.

Fueling



Stop the engine and let it cool before adding fuel. No smoking! Do not refuel a machine near open flames or sparks. Fill the fuel tank outdoors.

Ultra Low Sulfur Diesel (ULSD) poses a greater static ignition hazard than earlier diesel formulations with higher Sulfur content. Avoid death or serious injury from fire or explosion. Consult with your fuel or fuel system supplier to ensure the delivery system is in compliance with fueling standards for proper grounding and bonding practices.

Starting

Do not use ether or starting fluids on any engine that has glow plugs or air intake heater. These starting aids can cause explosion and injure you or bystanders.

Use the procedure in the Operation & Maintenance Manual for connecting the battery and for jump starting.

Spark Arrester Exhaust System

The spark arrester exhaust system is designed to control the emission of hot particles from the engine and exhaust system, but the muffler and the exhaust gases are still hot.

Check the spark arrester exhaust system regularly to make sure it is maintained and working properly. Use the procedure in the Operation & Maintenance Manual for cleaning the spark arrester muffler (if equipped).

FIRE PREVENTION (CONT'D)

Welding And Grinding

Always clean the machine and attachment, disconnect the battery, and disconnect the wiring from the Bobcat controllers before welding. Cover rubber hoses, battery and all other flammable parts. Keep a fire extinguisher near the machine when welding.

Have good ventilation when grinding or welding painted parts. Wear dust mask when grinding painted parts. Toxic dust or gas can be produced.

Dust generated from repairing nonmetallic parts such as hoods, fenders or covers can be flammable or explosive. Repair such components in a well ventilated area away from open flames or sparks.

Fire Extinguishers

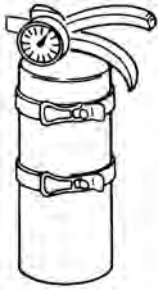

Know where fire extinguishers and first aid kits are located and how to use them. Inspect the fire extinguisher and service the fire extinguisher regularly. Obey the recommendations on the instructions plate.

SERIAL NUMBER LOCATIONS

Always use the serial number of the loader when requesting service information or when ordering parts. Earlier or later models (identification made by serial number) may use different parts, or it may be necessary to use a different procedure in doing a specific service operation.

Figure 1

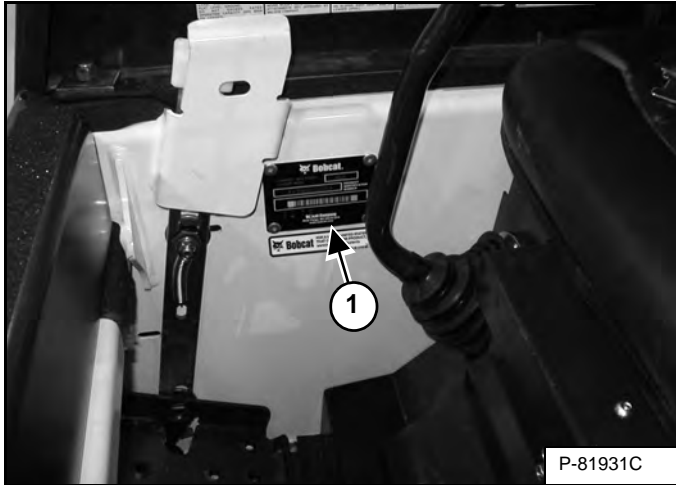

Loader Serial Number

The loader serial number plate (Item 1) **[Figure 1]** is located inside the cab on the right-hand side.

Figure 2

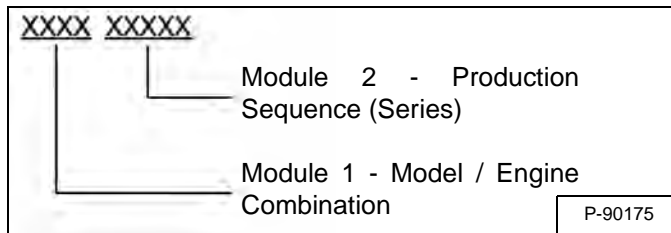

Explanation of loader Serial Number **[Figure 2]**:

1. The four digit Model / Engine Combination Module number identifies the model number and engine combination.
2. The five digit Production Sequence Number identifies the order which the loader is produced.

Engine Serial Number

Figure 3

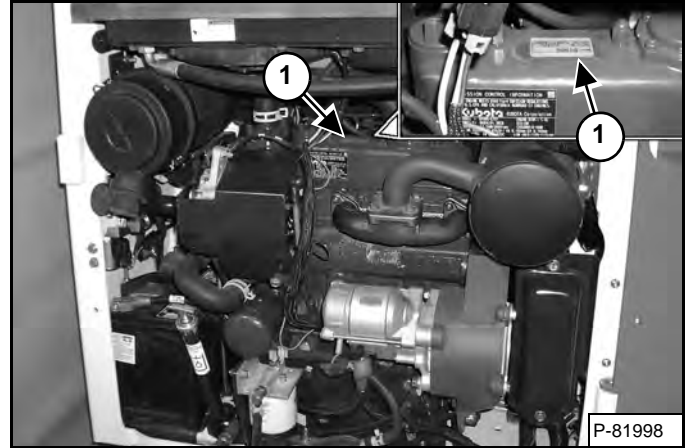

The engine serial number is located on top of the engine (Item 1) **[Figure 3]**.

DELIVERY REPORT

Figure 4

B-16315

The delivery report **[Figure 4]** contains a list of items that must be explained or shown to the owner or operator by the dealer when the Bobcat loader is delivered.

The delivery report must be reviewed and signed by the owner or operator and the dealer.

LOADER IDENTIFICATION

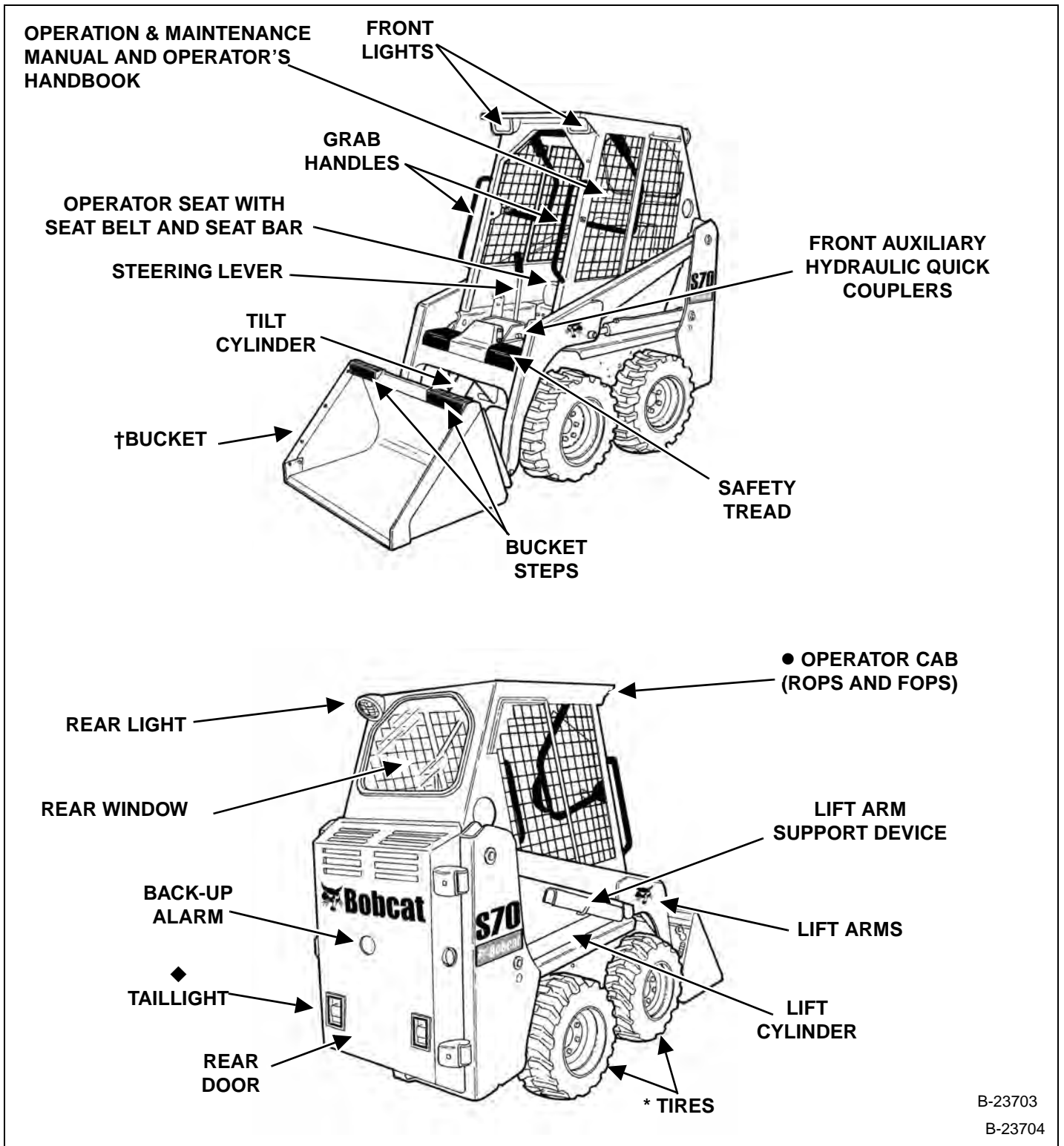

B-23703

B-23704

◆ OPTIONAL OR FIELD ACCESSORY (Not Standard Equipment).

* TIRES - Bobcats are base-equipped with standard tires.

† BUCKET - Several different buckets and other attachments are available for the Bobcat Loader.

● ROPS, FOPS - Roll Over Protective Structure, per ISO 3471, and Falling Object Protective Structure per ISO 3449, Level I.



Bobcat®

SAFETY AND MAINTENANCE

LIFTING AND BLOCKING THE LOADER	10-10-1
Procedure	10-10-1
LIFT ARM SUPPORT DEVICE	10-20-1
Installing	10-20-1
Removing	10-20-3
OPERATOR CAB	10-30-1
Description	10-30-1
Raising	10-30-2
Lowering	10-30-3
Special Applications Kit	10-30-5
Special Applications Kit Inspection And Maintenance	10-30-5
TRANSPORTING THE LOADER ON A TRAILER	10-40-1
Loading And Unloading	10-40-1
Fastening	10-40-2
TOWING THE LOADER	10-50-1
Procedure	10-50-1
REMOTE START TOOL KIT - MEL1563	10-60-1
Remote Start Tool - MEL1563	10-60-1
Service Tool Harness Communicator - MEL1566	10-60-2
Remote Start Procedure	10-60-3
REMOTE START TOOL (SERVICE TOOL) KIT -7217666	10-61-1
Description	10-61-1
Remote Start Tool (Service Tool) - 7022042	10-61-2
Loader Service Tool Harness - 6689747	10-61-3
Computer Service Tool Harness - 6689746	10-61-5
Remote Start Procedure	10-61-5
SERVICE SCHEDULE	10-70-1
Chart	10-70-1
AIR CLEANER SERVICE	10-80-1
Replacing Filter Elements	10-80-1
ENGINE COOLING SYSTEM	10-90-1
Cleaning	10-90-1
Checking Level	10-90-2
Removing And Replacing Coolant	10-90-3

FUEL SYSTEM	10-100-1
Fuel Specifications	10-100-1
Biodiesel Blend Fuel	10-100-1
Filling The Fuel Tank	10-100-2
Fuel Filter	10-100-3
Removing Air From The Fuel System	10-100-4
ENGINE LUBRICATION SYSTEM	10-110-1
Checking And Adding Engine Oil	10-110-1
Engine Oil Chart	10-110-1
Removing And Replacing Oil And Filter	10-110-2
HYDRAULIC / HYDROSTATIC SYSTEM	10-120-1
Checking And Adding Fluid	10-120-1
Hydraulic / Hydrostatic Fluid Chart	10-120-1
Removing And Replacing Hydraulic Fluid	10-120-2
Removing And Replacing Hydraulic / Hydrostatic Filter	10-120-3
Breather Cap	10-120-4
FINAL DRIVE TRANSMISSION (CHAINCASE)	10-130-1
Checking And Adding Oil	10-130-1
Removing And Replacing Oil	10-130-1
AUXILIARY CONTROL LOCKBOLT	10-140-1
Procedure	10-140-1
BOB-TACH	10-150-1
Inspection And Maintenance	10-150-1
LUBRICATING THE LOADER	10-160-1
Lubrication Locations	10-160-1
TIRE MAINTENANCE	10-170-1
Wheel Nuts	10-170-1
Rotating	10-170-1
Mounting	10-170-2
SPARK ARRESTER MUFFLER	10-180-1
Cleaning Procedure	10-180-1
PIVOT PINS	10-190-1
Inspection And Maintenance	10-190-1
SEAT BAR RESTRAINT SYSTEM	10-200-1
Description	10-200-1
Inspecting	10-200-1
Maintaining	10-200-2

LOADER STORAGE AND RETURN TO SERVICE	10-210-1
Storage	10-210-1
Return To Service	10-210-1
STOPPING THE ENGINE AND LEAVING THE LOADER	10-220-1
Procedure	10-220-1
EMERGENCY EXIT	10-230-1
Rear Window	10-230-1
Front Door	10-230-1
SEAT BELT	10-240-1
Inspection And Maintenance	10-240-1



Bobcat®

LIFTING AND BLOCKING THE LOADER

Procedure

! WARNING

AVOID INJURY OR DEATH

Instructions are necessary before operating or servicing machine. Read and understand the Operation & Maintenance Manual, Operator's Handbook and signs (decals) on machine. Follow warnings and instructions in the manuals when making repairs, adjustments or servicing. Check for correct function after adjustments, repairs or service. Untrained operators and failure to follow instructions can cause injury or death.

W-2003-0807

Figure 10-10-1



! WARNING

Put jackstands under the front axles and rear corners of the frame before running the engine for service. Failure to use jackstands can allow the machine to fall or move and cause injury or death.

W-2017-0286

Figure 10-10-2



Always park the loader on a level surface.

Put a floor jack under the rear of the loader [Figure 10-10-2].

Lift the rear of the loader and install jackstands [Figure 10-10-2].

Figure 10-10-3

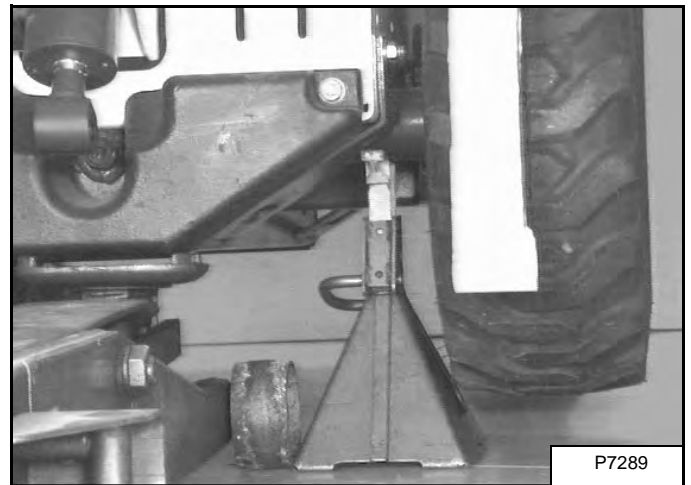

Put the floor jack under the front of the loader [Figure 10-10-3].

Lift the front of the loader and put jackstands under the loader frame.

NOTE: Make sure the jackstands do not touch the tires.



Bobcat®

LIFT ARM SUPPORT DEVICE

Installing

Maintenance and service work can be done with the lift arms lowered. If the lift arms are raised, use the following procedures to engage and disengage an approved lift arm support device.

! WARNING

Never work on a machine with the lift arms up unless the lift arms are secured by an approved lift arm support device. Failure to use an approved lift arm support device can allow the lift arms or attachment to fall and cause injury or death.

Service lift arm support device if damaged or if parts are missing. Using a damaged lift arm support or with missing parts can cause lift arms to drop causing injury or death.

W-2572-0407

Remove attachment from the loader. (See Removal And Installation on Page 50-40-1.)

! DANGER

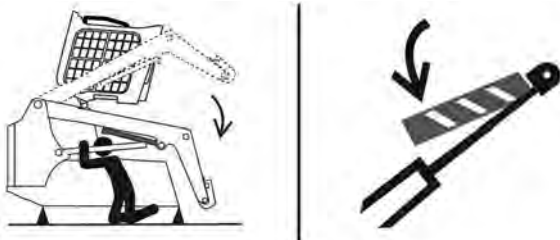

P-90328

AVOID DEATH

- Disconnecting or loosening any hydraulic tubeline, hose, fitting, component or a part failure can cause lift arms to drop.
- Keep out of this area when lift arms are raised unless supported by an approved lift arm support. Replace if damaged.

D-1009-0409

! WARNING

Before the cab or the lift arms are raised for service, jackstands must be put under the rear corners of the frame. Failure to use jackstands can allow the machine to tip backward causing injury or death.

W-2014-0895

Figure 10-20-1

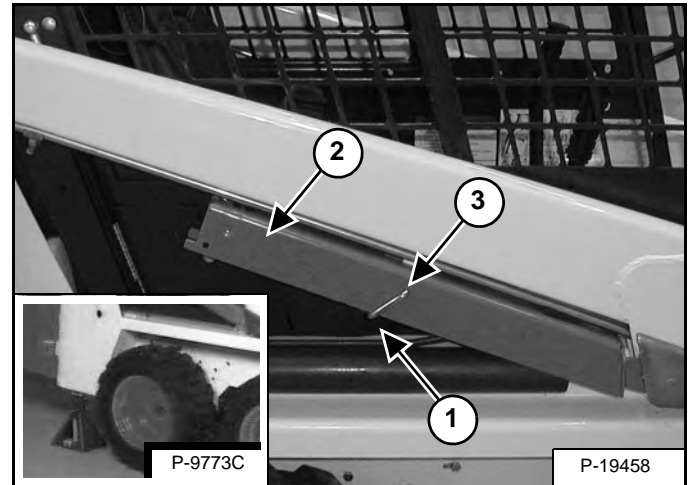

Put jackstands under the rear corners of the loader frame (Inset) [Figure 10-20-1].

Disconnect the spring (Item 1) from the lift arm support device retaining pin, Support the lift arm support device (Item 2) with your hand and remove the retaining pin (Item 3) [Figure 10-20-1].

Figure 10-20-2

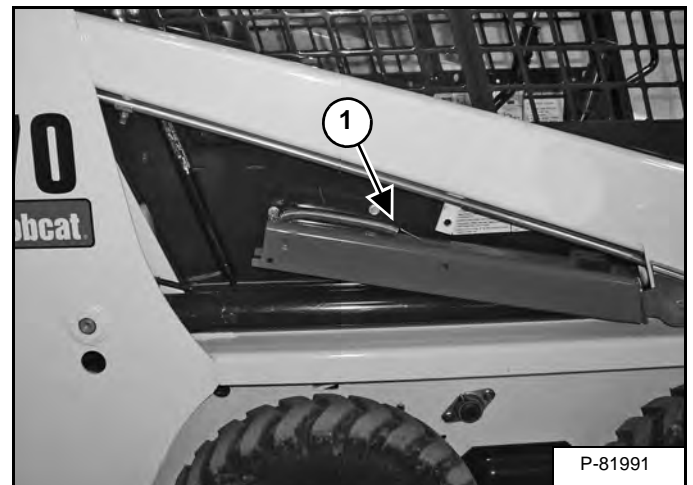

Lower the lift arm support device to the top of the lift cylinder. Hook the free end of the spring (Item 1) [Figure 10-20-2] to the lift arms support device so there will be no interference with the support device engagement.

LIFT ARM SUPPORT DEVICE (CONT'D)

Installing (Cont'd)

With the operator in the seat, seat belt fastened and seat bar lowered, start the engine, press the PRESS TO OPERATE LOADER Button.

Figure 10-20-3

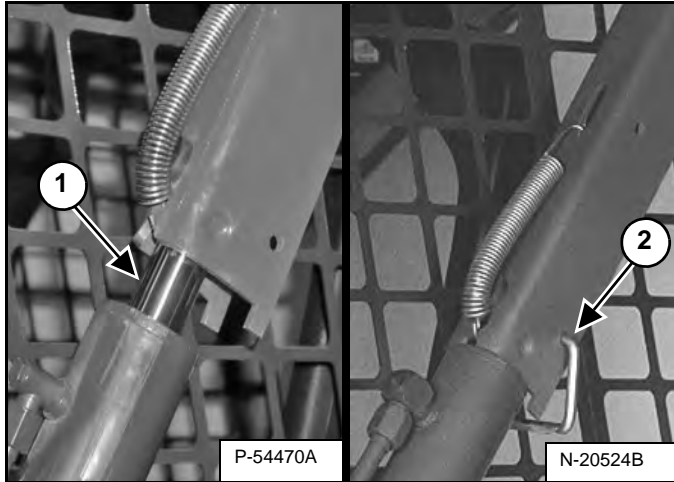

Raise the lift arms until the lift arm support device drops onto the lift cylinder rod (Item 1) **[Figure 10-20-3]**.

Lower the lift arms slowly until the support device is held between the lift arm and the lift cylinder.

Stop the engine. Raise the seat bar and move both pedals until both pedals lock.

Install pin (Item 2) **[Figure 10-20-3]** into the rear of the lift arm support device below the cylinder rod.

LIFT ARM SUPPORT DEVICE (CONT'D)

Removing

Figure 10-20-4

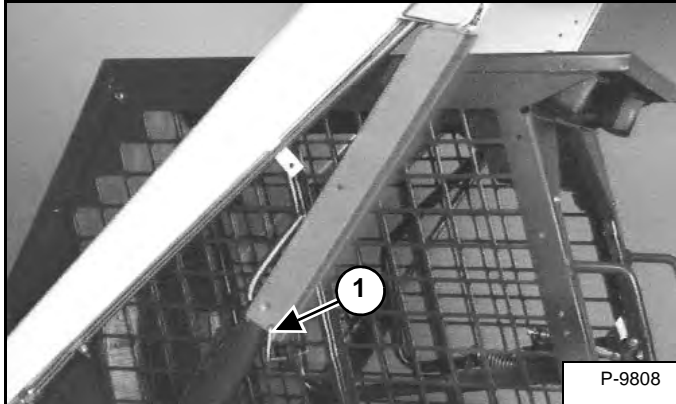

Remove the retaining pin (Item 1) [Figure 10-20-4] from the lift arm support device.

Figure 10-20-5

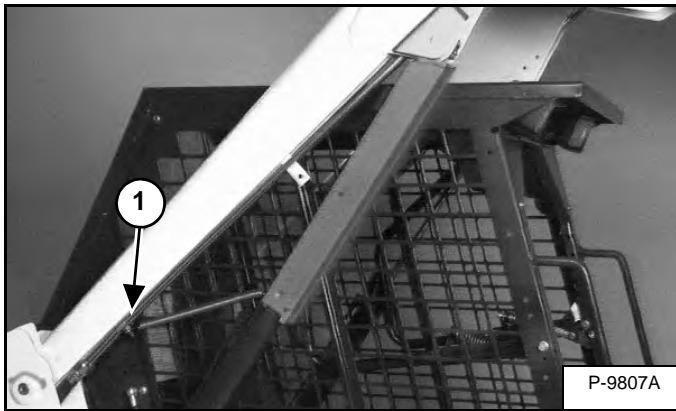

Connect the spring from the lift arm support device to the tubeline bracket (Item 1) [Figure 10-20-5] on the lift arms.

With the operator in the seat, seat belt fastened and seat bar lowered, start the engine, press the PRESS TO OPERATE LOADER Button.

Raise the lift arms a small amount. The spring will lift the support device off the lift cylinder rod.

Lower the lift arms and stop the engine.

Raise the seat bar, disconnect the seat belt and move the pedals until both pedals lock.

Disconnect the spring from the bracket.

Figure 10-20-6

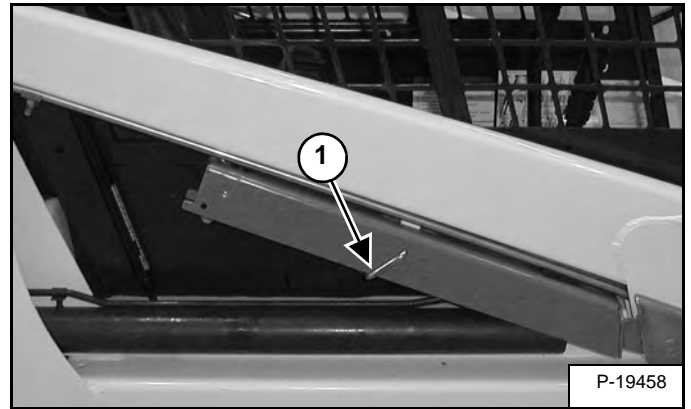

Raise the support device into storage position and insert the pin through the lift arm support device and bracket (Item 1) [Figure 10-20-6].

Connect the spring to the pin [Figure 10-20-6]

Remove the jackstands.



Bobcat®

OPERATOR CAB

Description

The Bobcat loader has an operator cab (ROPS and FOPS) as standard equipment to protect the operator from rollover and falling objects. The seat belt must be worn for rollover protection.

Check the ROPS / FOPS cab, mounting and hardware for damage. Never modify the ROPS / FOPS cab. Replace the cab and hardware if damaged.

ROPS / FOPS - Roll Over Protective Structure per ISO 3471, and Falling Object Protective Structure per ISO 3449, Level I.

Level I - Protection from falling bricks, small concrete blocks, and hand tools encountered in operations such as highway maintenance, landscaping, and other construction sites.

WARNING

Never modify operator cab by welding, grinding, drilling holes or adding attachments unless instructed to do so by Bobcat Company. Changes to the cab can cause loss of operator protection from rollover and falling objects, and result in injury or death.

W-2069-0200

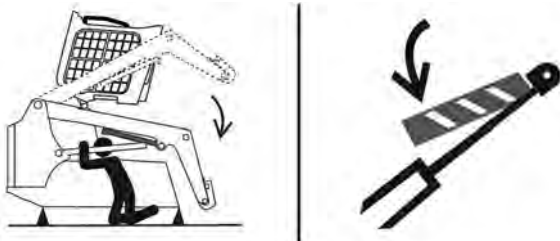

P-90328

AVOID DEATH

- Disconnecting or loosening any hydraulic tubeline, hose, fitting, component or a part failure can cause lift arms to drop.
- Keep out of this area when lift arms are raised unless supported by an approved lift arm support. Replace if damaged.

D-1009-0409

OPERATOR CAB (CONT'D)

Raising

Always stop the engine before raising or lowering the cab.

Stop the loader on a level surface and lower the lift arms. If the lift arms must be up while raising the operator cab, install the lift arm support device. (See LIFT ARM SUPPORT DEVICE on Page 10-20-1.)

WARNING

Before the cab or the lift arms are raised for service, jackstands must be put under the rear corners of the frame. Failure to use jackstands can allow the machine to tip backward causing injury or death.

W-2014-0895

Figure 10-30-1

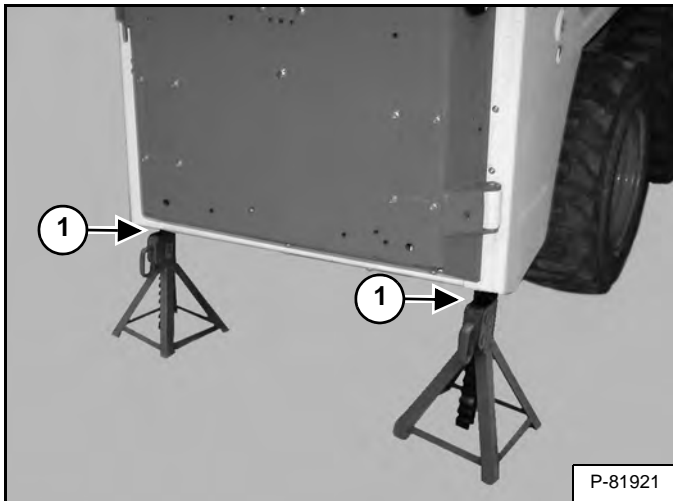

Install jackstands (Item 1) [Figure 10-30-1] under the rear corners of the loader frame.

Figure 10-30-2

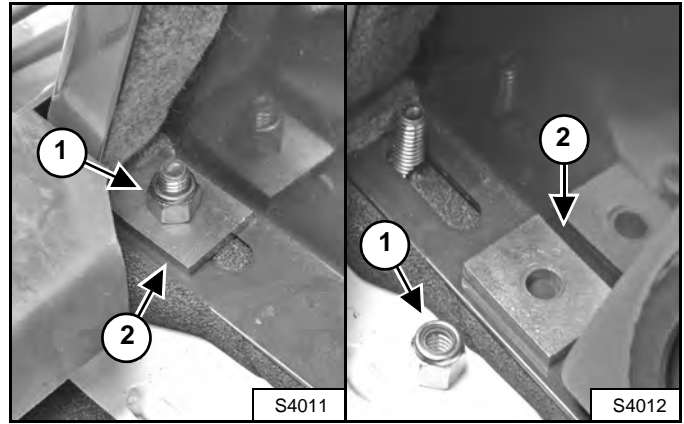

Remove the nut and plate (Items 1 and 2) [Figure 10-30-2] on the inside front corner of the cab (both sides).

Figure 10-30-3



Lift on the grab handle and bottom of the operator cab slowly until the cab is all the way up and the latching mechanism engages [Figure 10-30-3].

OPERATOR CAB (CONT'D)

Lowering



AVOID INJURY OR DEATH

The cab must be held to prevent falling while hand is in access hole.

W-2205-1207

Always stop the engine before raising or lowering the cab.

Figure 10-30-4

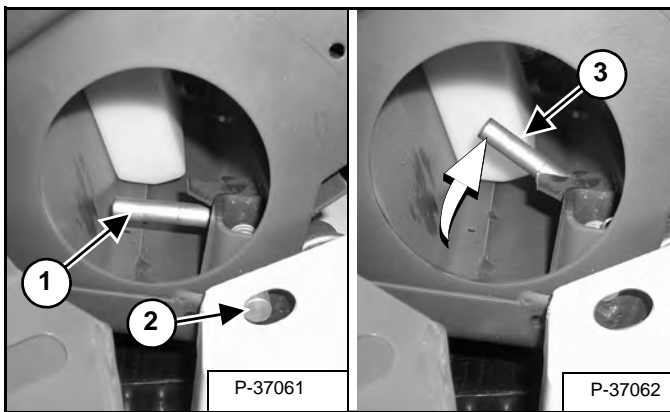

Hold the operator cab. Release the locking mechanism by pushing the lever (Item 1) in from the locked position (Item 2) and turning the lever until it stays in the unlocked position (Item 3) [Figure 10-30-4].

REMOVE YOUR HAND FROM THE HOLE BEFORE LOWERING THE OPERATOR CAB.

Stand on the ground and pull the cab down. Avoid slippery surfaces. Use both hands to lower the cab all the way down.

NOTE: The weight of the cab increases when equipped with options and accessories such as cab door, heater, etc. In these cases, the cab may need to be raised slightly from the latch to be able to release the latch.

NOTE: Always use the grab handles (once you can reach them) to lower the cab.

Figure 10-30-5

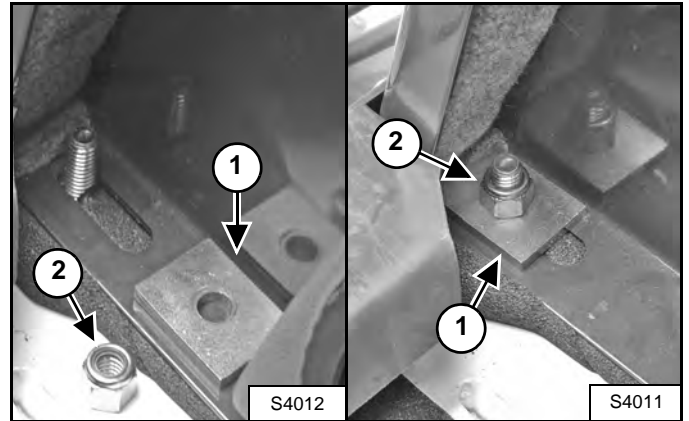

Install the plates and nuts (Items 1 and 2) [Figure 10-30-5] (both sides).

Tighten the nuts to 54 - 61 N•m (40 - 45 ft-lb) torque.

Remove the jackstands.

OPERATOR CAB (CONT'D)

Later Model Heater

Lowering (Cont'd)

If Equipped With A Heater, Do The Following:

Earlier Model Heater

NOTE: The heater hose connectors will disconnect when the cab is raised. The heater hose connectors must be reconnected for the heater to work after the cab is lowered and secured.

Move the seat as far forward as needed to access the heater hose connectors that are located at the rear of the cab.

The heater hoses are routed through the rear wall of the cab behind the heater and will remain connected while raising and lowering the cab.

Figure 10-30-6

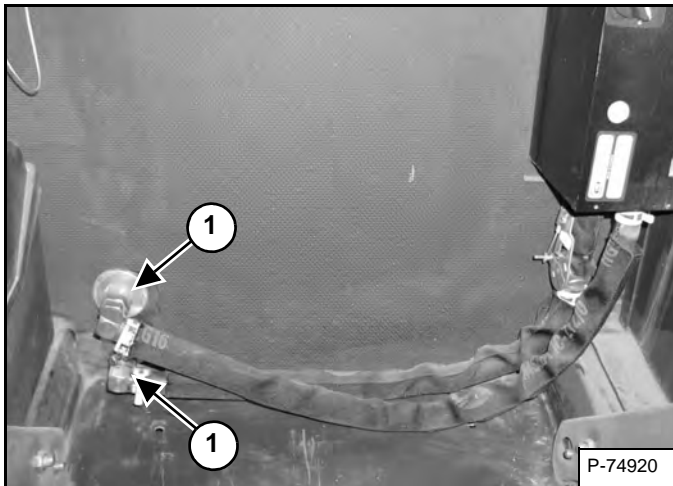

From behind the operator's seat, push the two heater quick connectors (Item 1) [Figure 10-30-6] into the heater couplers.

OPERATOR CAB (CONT'D)

Special Applications Kit



AVOID INJURY OR DEATH

Some attachment applications can cause flying debris or objects to enter front, top or rear cab openings. Install the Special Applications Kit and Top Guard (if applicable) to provide added operator protection in these applications.

W-2737-0917

Figure 10-30-7

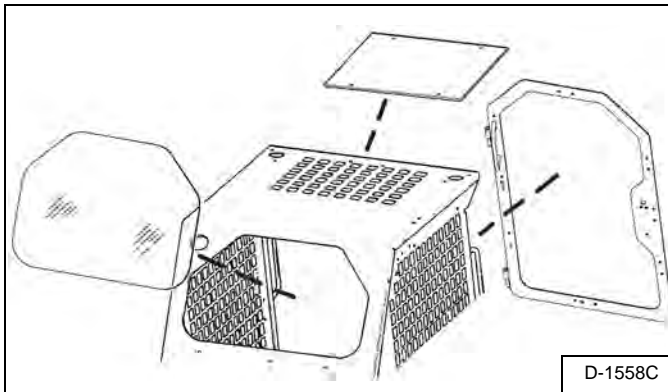

Available for special applications to restrict material from entering cab openings. Kit includes 12,7 mm (0.5 in) thick polycarbonate front door, 6,4 mm (0.25 in) thick polycarbonate top and rear windows [Figure 10-30-7].

Special Applications Kit Inspection And Maintenance

- Inspect for cracks or damage. Replace if required.
- Prerinse with water to remove gritty materials.
- Wash with a mild household detergent and warm water.
- Use a sponge or soft cloth. Rinse well with water and dry with a clean soft cloth or rubber squeegee.
- Do not use abrasive or highly alkaline cleaners.
- Do not clean with metal blades or scrapers.



Bobcat®

TRANSPORTING THE LOADER ON A TRAILER

Loading And Unloading

WARNING

AVOID SERIOUS INJURY OR DEATH

Adequately designed ramps of sufficient strength are needed to support the weight of the machine when loading onto a transport vehicle. Wood ramps can break and cause personal injury.

W-2058-0807

Be sure the transport and towing vehicles are of adequate size and capacity for the weight of the loader. (See Performance (A3W6, A3W7, B38V, B38W 11001 & Above) on Page SPEC-10-2.) or (See Performance (B4TY11001 & Above And B4UC11001 & Above) on Page SPEC-10-2.).

Figure 10-40-1

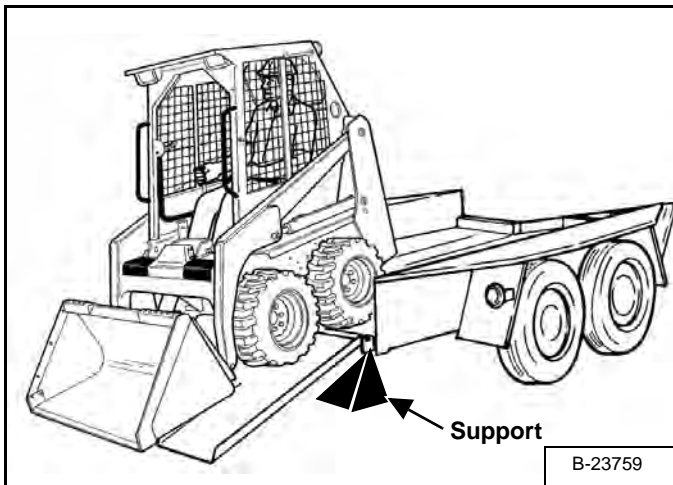

A loader with an empty bucket or no attachment must be loaded backward onto the transport vehicle [Figure 10-40-1].

The rear of the trailer must be blocked or supported [Figure 10-40-1] when loading or unloading the loader to prevent the front end of the trailer from raising up.

TRANSPORTING THE LOADER ON A TRAILER (CONT'D)

Fastening

Figure 10-40-2

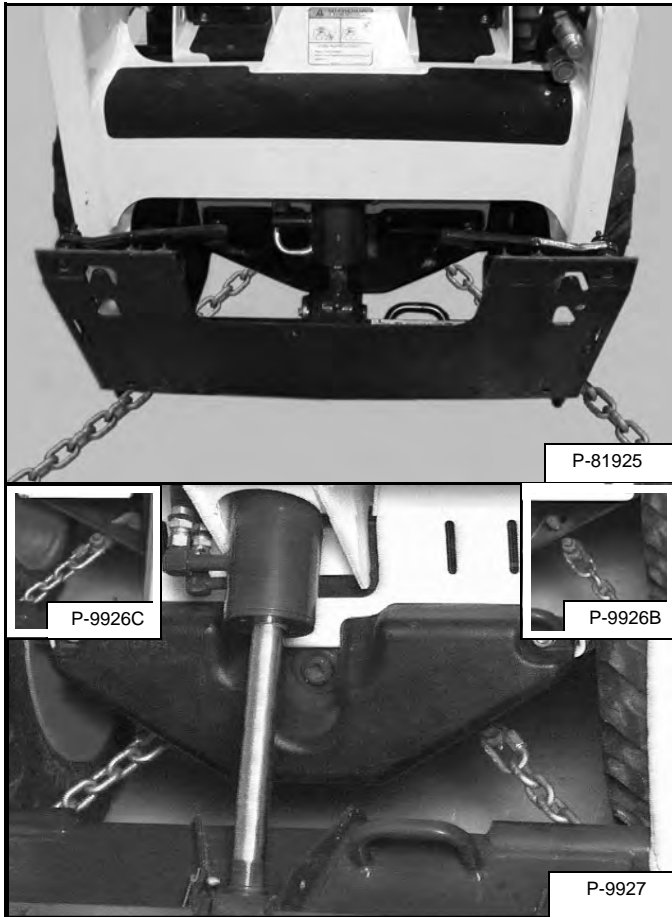

Use the following procedure to fasten the Bobcat loader to the transport vehicle to prevent the loader from moving during sudden stops or when going up or down slopes [Figure 10-40-2].

- Lower the bucket or attachment to the floor.
- Stop the engine.
- Engage the parking brake.
- Install chains at the front and rear loader tie down positions [Figure 10-40-2].
- Fasten each end of the chain to the transport vehicle.

Figure 10-40-3

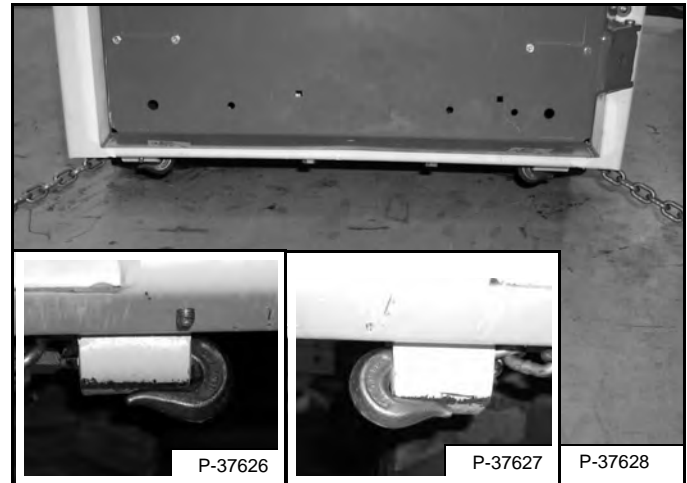

- Install chains at the rear tie down positions [Figure 10-40-3].
- Fasten each end of the chain to the transport vehicle.

TOWING THE LOADER

Procedure

Because of the design of the loader, there is not a recommended towing procedure.

- The loader can be lifted onto a transport vehicle.
- The loader can be skidded a short distance to move for service (EXAMPLE: Move onto a transport vehicle.) without damage to the hydrostatic system. (The wheels will not turn.) There might be slight wear to the tires when the loader is skidded.

The towing chain (or cable) must be rated at 1.5 times the weight of the loader



Bobcat®

REMOTE START TOOL KIT - MEL1563

Remote Start Tool - MEL1563

Tools that will be needed to complete the following steps are:

MEL1563 - Remote Start Tool Kit

MEL1566 - Service Tool Harness Communicator (Computer Interface)

Figure 10-60-1

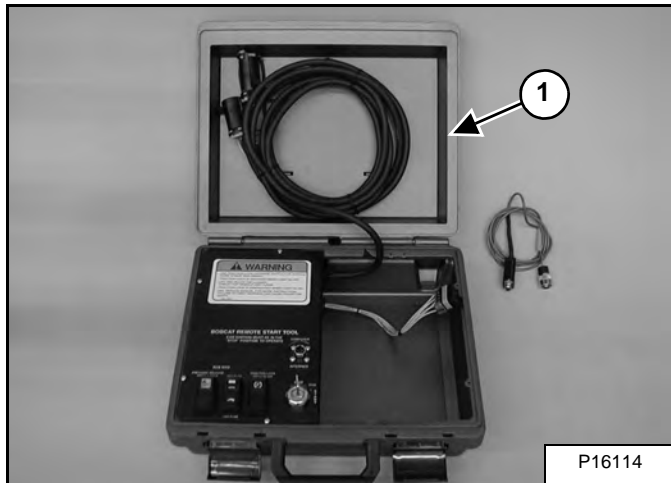

The Remote Start Tool (Item 1) [Figure 10-60-1] is required when the service technician is checking the hydraulic / hydrostatic system or adjusting the steering linkage.

Figure 10-60-2

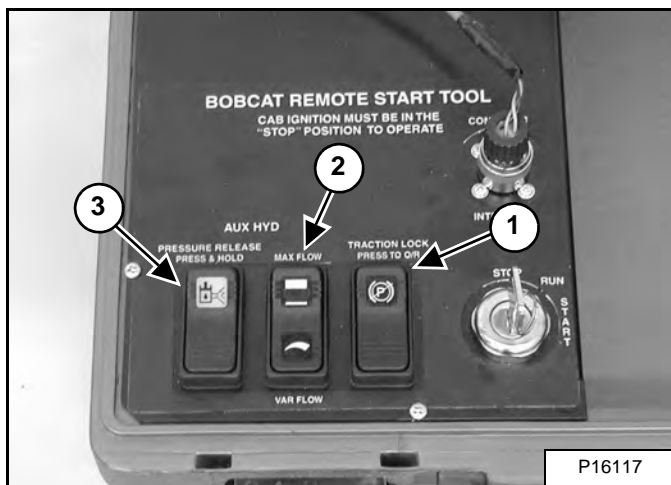

The traction lock switch (Item 1) [Figure 10-60-2] is used to turn traction lock ON or OFF. Push the switch to the override position. The switch will illuminate to indicate traction lock OVERRIDE, in this position the wheels are able to turn.

The maximum flow / variable flow switch (Item 2) [Figure 10-60-2] is used to activate the auxiliary hydraulics. Pressing the switch once will activate the auxiliary hydraulics. Pressing the switch again will deactivate the auxiliary hydraulics. The switch is used when checking pressures and flow rate.

The auxiliary pressure release (Item 3) [Figure 10-60-2] is not used.

Figure 10-60-3

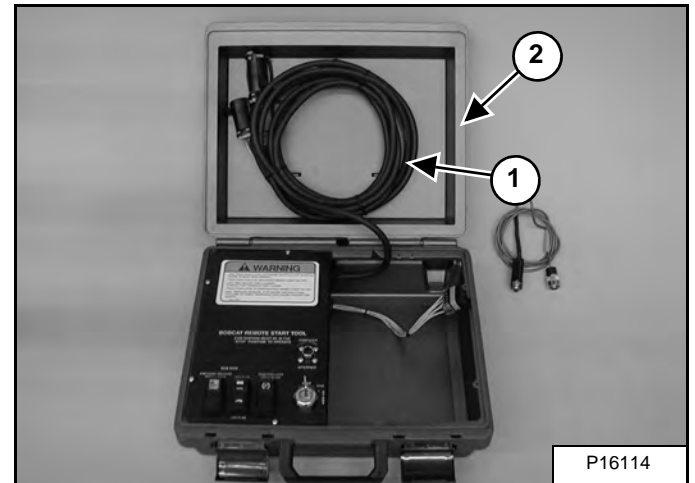

Remove the Service Tool Harness (Item 1) from the cover (Item 2) [Figure 10-60-3].

Figure 10-60-4

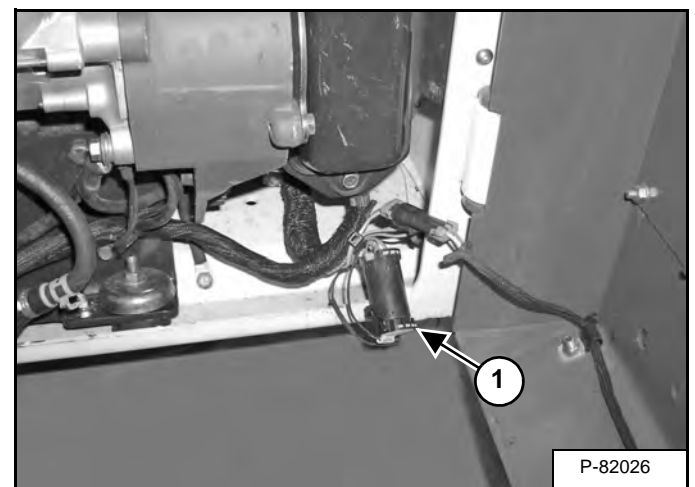

Remove the plug (Item 1) [Figure 10-60-4] from the loader harness connector.

Connect the service tool harness control to the loader harness connector.

REMOTE START TOOL KIT - MEL1563 (CONT'D)

Remote Start Tool - MEL1563 (Cont'd)

Figure 10-60-5

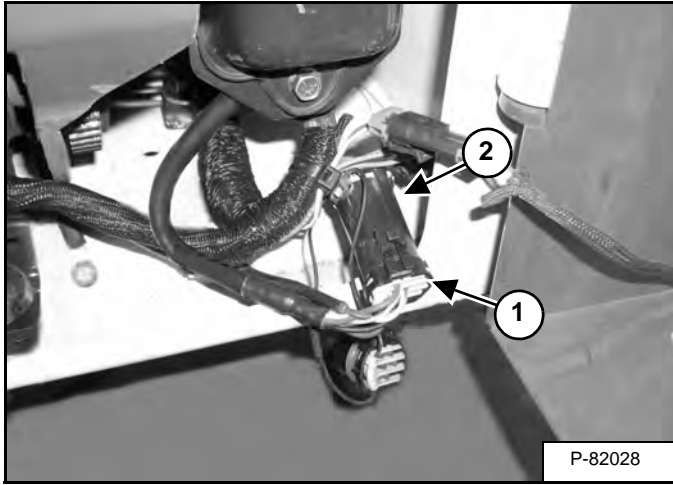

Loaders equipped with an attachment harness (Item 1) must disconnect the attachment harness from the loader harness (Item 2) [Figure 10-60-5].

Connect the service tool harness to the ACD connector and the loader harness connector. Make sure the cap is on the other connector when not being used.

NOTE: To monitor, diagnose or load new software the Service PC must be connected to the Remote Start Tool.

Service Tool Harness Communicator - MEL1566

Figure 10-60-6

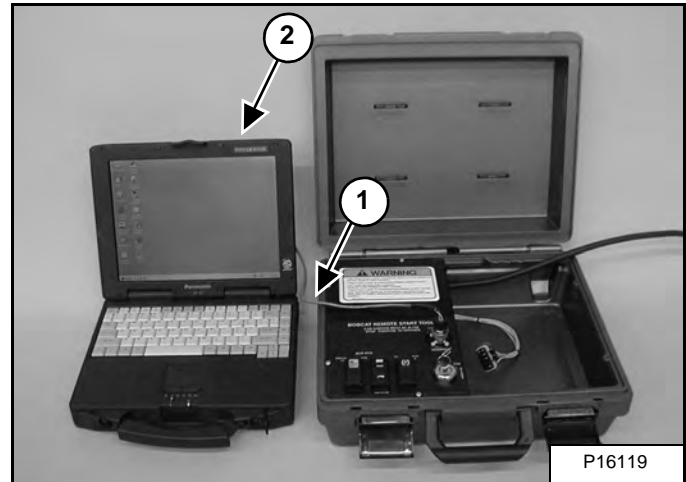

The Service Tool Harness Communicator (Item 1) is required to connect Remote Start Tool to the Service PC (Item 2) [Figure 10-60-6].

REMOTE START TOOL KIT - MEL1563 (CONT'D)

Remote Start Procedure

The tool listed will be needed to do the following procedure:

MEL1563: Remote Start Tool Kit

Figure 10-60-7

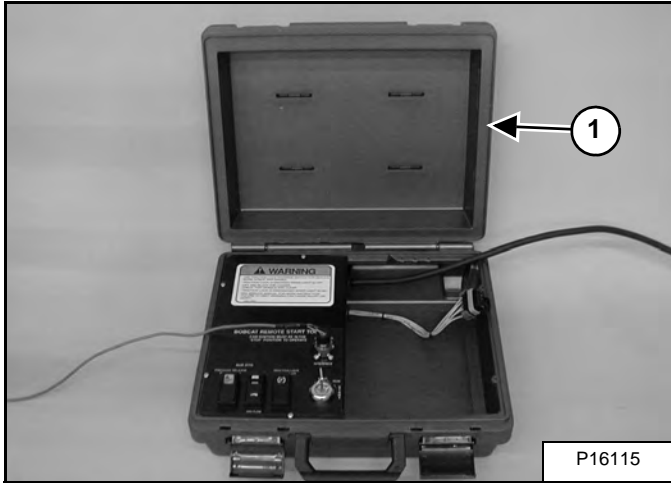

The Remote Start Tool (Item 1) [Figure 10-60-7] is required when the operator cab is in the raised position for service and the service technician needs to turn the key switch on or start the engine. Example: adjusting the steering linkage.

Lift and block the loader.

Raise the lift arms (if required by the procedure) and install an approved lift arm support device.

Raise the operator cab (if required by the procedure).

Open the rear door of the loader.

Figure 10-60-8

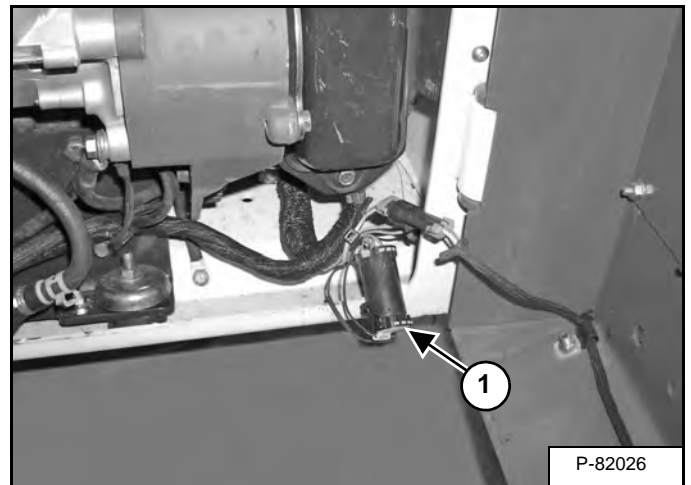
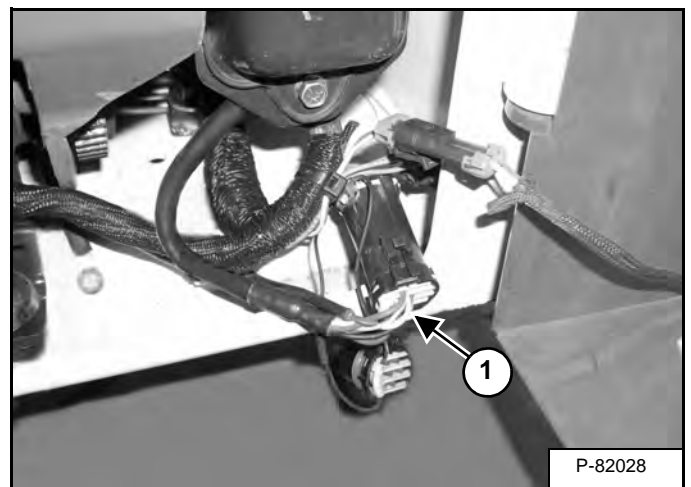

Figure 10-60-9



Remove the plug (Item 1) [Figure 10-60-8] or disconnect the attachment control harness (Item 1) [Figure 10-60-9] if connected.

REMOTE START TOOL KIT - MEL1563 (CONT'D)

Remote Start Procedure (Cont'd)

Figure 10-60-10

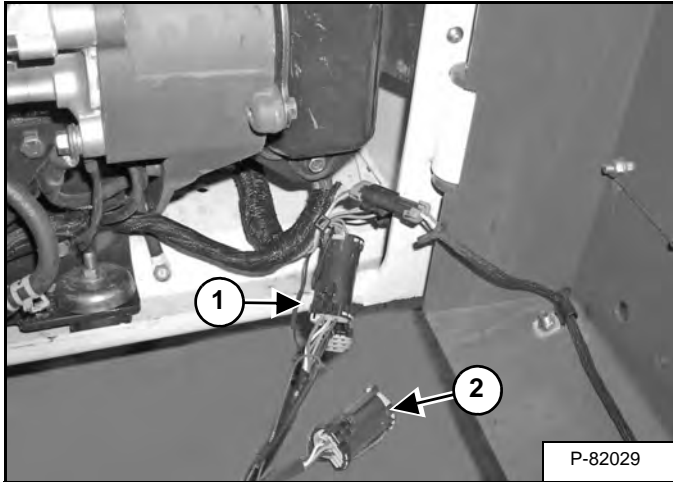

Connect the Remote Start Tool to the engine harness connector (Item 1) [Figure 10-60-10].

NOTE: The key switch on the right-hand side operator panel must be in the off position or the Remote Start Kit will not operate.

NOTE: Make sure the cap (Item 2) [Figure 10-60-10] is installed on the second connector when not in use.

WARNING

UNAUTHORIZED AND UNEXPECTED ENGINE START-UP CAN CAUSE SERIOUS INJURY OR DEATH

With the 7-pin connector plugged into the machine and Remote Start Tool Key Switch in the OFF position, the engine can be started from the operator panel inside the cab.

- Place the key switch of the Remote Start Tool in the RUN position to disconnect the operator panel from the start circuit.
- Remove the operator panel key (key switch), lock the keypad with a unique password (keyless) or otherwise disable the starter before working in the engine area.

W-2457-1110

Figure 10-60-11

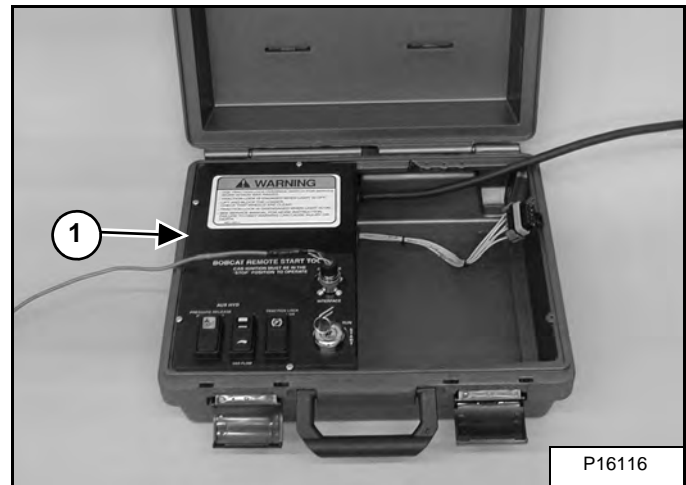

The Remote Start Tool (Item 1) [Figure 10-60-11] has three rocker switches.

REMOTE START TOOL KIT - MEL1563 (CONT'D)

Remote Start Procedure (Cont'd)

Figure 10-60-12

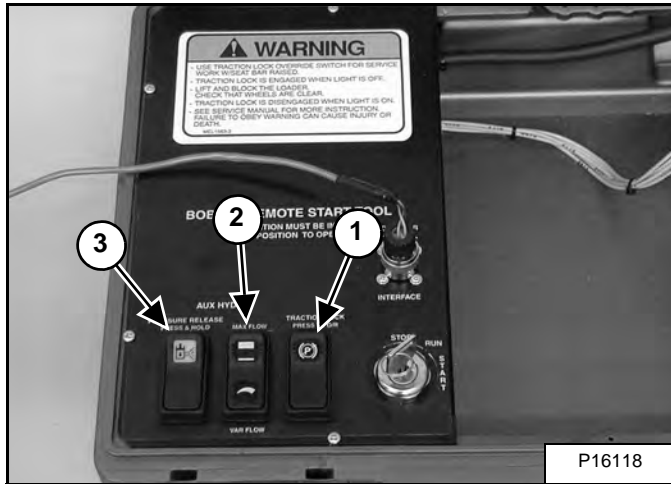

The traction lock switch (Item 1) [Figure 10-60-12] is used to turn traction lock on or off. Push the switch to the override position. The switch will illuminate to indicate traction lock **OVERRIDE**, in this position the wheels are able to turn.

The maximum flow / variable flow switch (Item 2) [Figure 10-60-12] is used to activate the auxiliary hydraulics. Pressing the switch once will activate the auxiliary hydraulics. Pressing the switch again will deactivate the auxiliary hydraulics. The switch is used when checking pressures and flow rate.

NOTE: With the engine off and the auxiliaries enabled, move the auxiliary controls left and right to relieve pressure.

The auxiliary pressure release (Item 3) [Figure 10-60-12] is not used.

WARNING

AVOID INJURY OR DEATH

- Use traction lock override switch for service work with seat bar raised.
- Traction lock is engaged when light is **OFF**.
- Lift and block the loader. Check that wheels are clear.
- Traction lock is disengaged when light is **ON**.
- See Service Manual for more instruction.

W-2785-0209

Figure 10-60-13

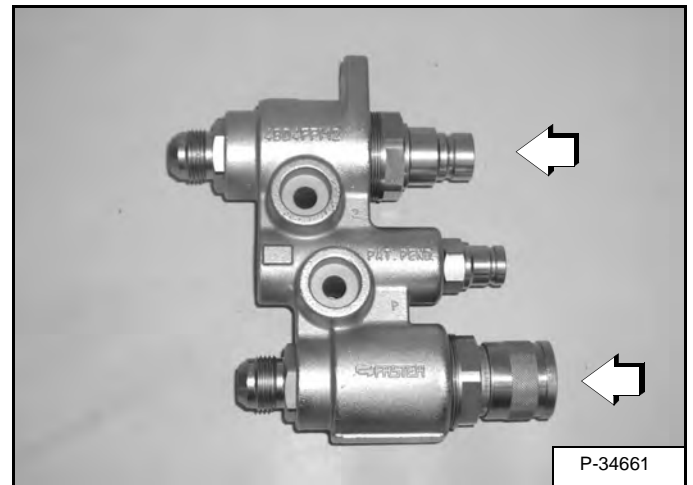

Push the couplers on the front auxiliary block toward the block and hold for five seconds to release the front auxiliary pressure [Figure 10-60-13].



Bobcat®

REMOTE START TOOL (SERVICE TOOL) KIT - 7217666

Description

The Remote Start Tool (Service Tool) Kit is a replacement tool for MEL1563 Remote Start Tool and MEL1400B - BOSS® Diagnostic Tool.

The Remote Start Tool (Service Tool) Kit, P/N 7217666, can be used to service older loaders with the BOSS® system using the supplied BOSS® Service Tool Harness P/N 6689745.

The Remote Start Tool (Service Tool) Kit, P/N 7217666, can be used to service newer loaders using the supplied harness P/N 6689747.

A computer can be connected to the Remote Start Tool (Service Tool) for diagnostics and software updates using the computer harness P/N 6689746 in conjunction with the loader harness.

REMOTE START TOOL (SERVICE TOOL) KIT - 7217666 (CONT'D)

Remote Start Tool (Service Tool) - 7022042

Tools that will be needed to complete the following steps are:

Order from Bobcat Parts P/N: 7217666 - Remote Start Tool (Service Tool) Kit

Kit Includes:

7022042 - Remote Start Tool (Service Tool)
6689747 - Loader Service Tool Harness
6689746 - Computer Service Tool Harness
6689745 - BOSS® Service Tool Harness

Figure 10-61-1

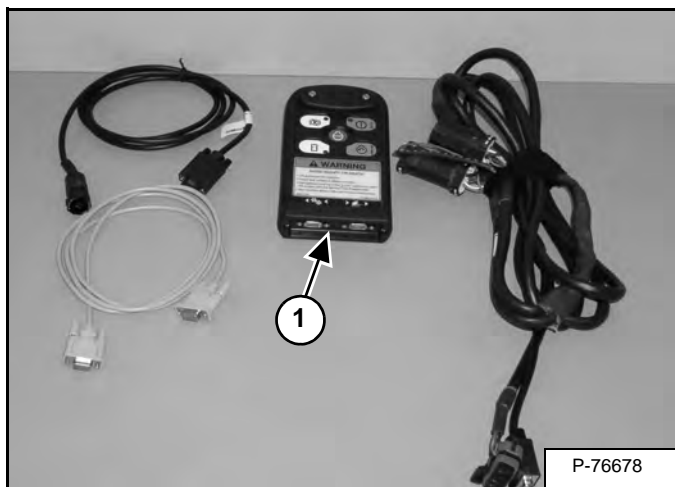

The Remote Start Tool (Item 1) [Figure 10-61-1] is required when the service technician is checking the hydraulic / hydrostatic system or adjusting the steering linkage.

Figure 10-61-2

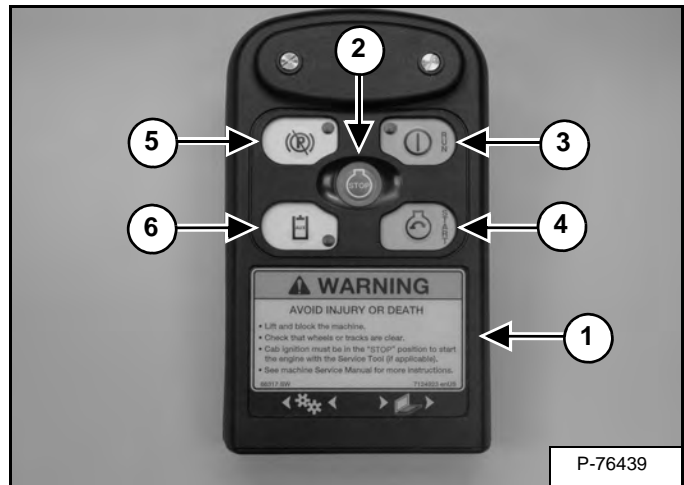

The Remote Start Tool (Service Tool) (Item 1) [Figure 10-61-2] has five buttons.

The STOP button (Item 2) [Figure 10-61-2] is used to stop the Remote Start Tool (Service Tool) from communicating and stop the loader engine.

The RUN button (Item 3) [Figure 10-61-2] is used to turn the Remote Start Tool (Service Tool) on and activates the loader ignition power. The button will illuminate to indicate the service tool is active.

The START button (Item 4) [Figure 10-61-2] is used to start the loader engine.

The traction lock button (Item 5) [Figure 10-61-2] is used to turn traction lock ON or OFF. Push the button and the button will illuminate indicating the traction lock is disabled in which the wheels or tracks are able to turn.

The auxiliary button (Item 6) [Figure 10-61-2] is used to activate the auxiliary hydraulics. The button will illuminate to indicate the auxiliary hydraulics are active. Pressing the button a second time will turn the flow OFF. The button is used when checking pressures and flow rate.

REMOTE START TOOL (SERVICE TOOL) KIT - 7217666 (CONT'D)

Loader Service Tool Harness - 6689747

Figure 10-61-3

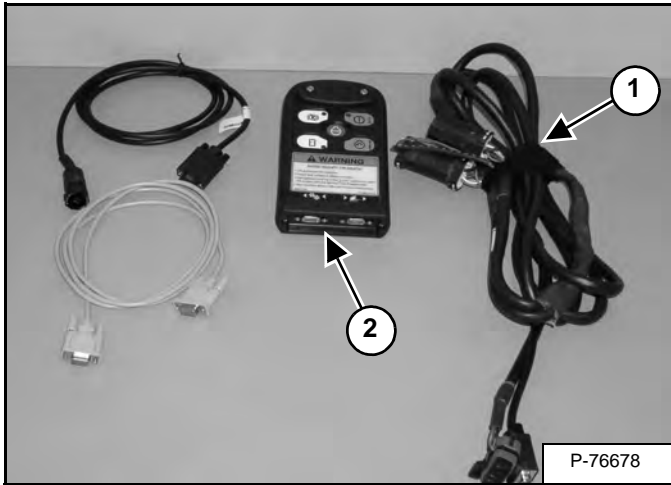

The Loader Service Tool Harness (Item 1) [Figure 10-61-3] is used to connect the Remote Start Tool (Service Tool) (Item 2) [Figure 10-61-3] to the electrical system on the loader.

Figure 10-61-4

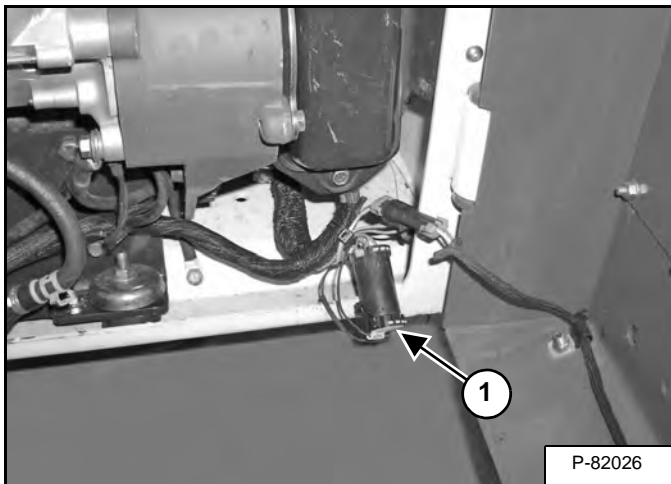

Loaders without an attachment control harness, remove the loader harness cap (Item 1) [Figure 10-61-4] and connect the Loader Service Tool Harness from the Remote Start Tool (Service Tool).

Figure 10-61-5

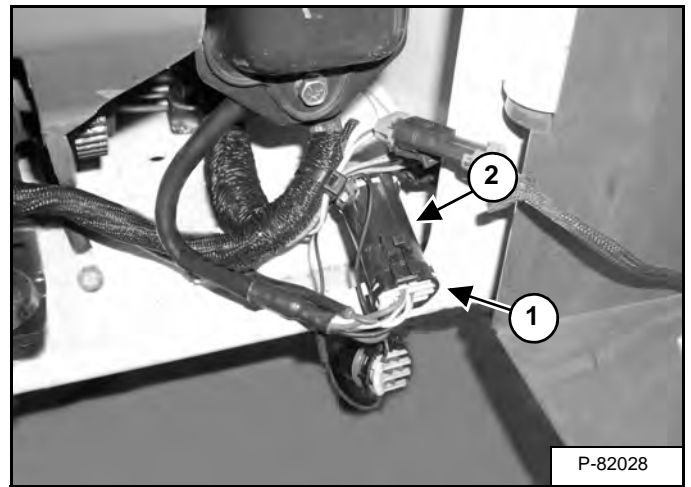

Loaders with an attachment control harness (7 pin or 14 pin), the attachment harness (Item 1) must be disconnected from the loader harness (Item 2) [Figure 10-61-5].

When the remote start procedure is completed, replace the loader connector cap (Item 1) [Figure 10-61-4] or reconnect the attachment control harness to the loader harness [Figure 10-61-5].

REMOTE START TOOL (SERVICE TOOL) KIT -
7217666 (CONT'D)

Loader Service Tool Harness - 6689747 (Cont'd)

Figure 10-61-6

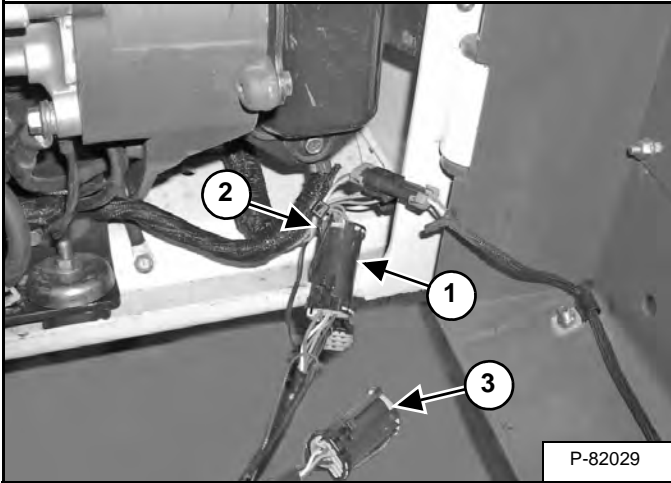

NOTE: The Remote Start Tool (Service Tool) connection harness has two connectors (Item 1) and (Item 3). The main connector (Item 1) [Figure 10-61-6] is always used for connection to the loader harness.

The second connector (Item 3) [Figure 10-61-6] is used for attachment ACD upgrades or attachment operational diagnostics only. This connector has a cap that must be installed when connector is not being used.

Connect the Remote Start Tool (Service Tool) connector (Item 1) to the loader harness connector (Item 2) and the other Remote Start Tool (Service Tool) connector to the ACD harness connector (Item 3) [Figure 10-61-6].

NOTE: The right instrument panel (Key Switch or Keyless) must be in the off position or the Remote Start Tool (Service Tool) will not operate.

! WARNING

AVOID INJURY OR DEATH

- Lift and block the machine.
- Check that wheels or tracks are clear.
- Cab ignition must be in the “STOP” position to start the engine with the Service Tool (if applicable).
- See machine Service Manual for more instructions.

W-2792-0409

REMOTE START TOOL (SERVICE TOOL) KIT - 7217666 (CONT'D)

Computer Service Tool Harness - 6689746

Figure 10-61-7

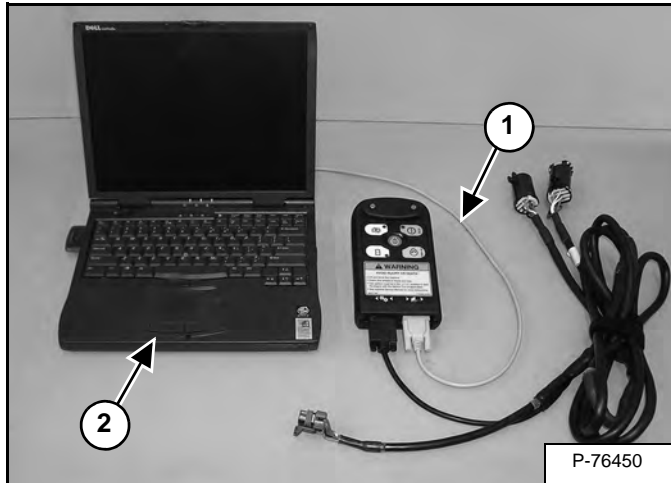

The Computer Service Tool Harness (Item 1) [Figure 10-61-7] is required to connect Remote Start Tool (Service Tool) to the Service PC (Item 2) [Figure 10-61-7].

Remote Start Procedure

WARNING

UNAUTHORIZED AND UNEXPECTED ENGINE START-UP CAN CAUSE SERIOUS INJURY OR DEATH
With the 7-pin connector plugged into the machine and Remote Start Tool RUN button not illuminated, the engine can be started from the operator panel inside the cab.

- Press the RUN button of the Remote Start Tool to disconnect the operator panel from the start circuit.
- Remove the operator panel key (key switch), lock the keypad with a unique password (keyless) or otherwise disable the starter before working in the engine area.

W-2661-1110

The tool listed will be needed to do the following procedure:

7217666: Remote Start Tool (Service Tool) Kit

Figure 10-61-8

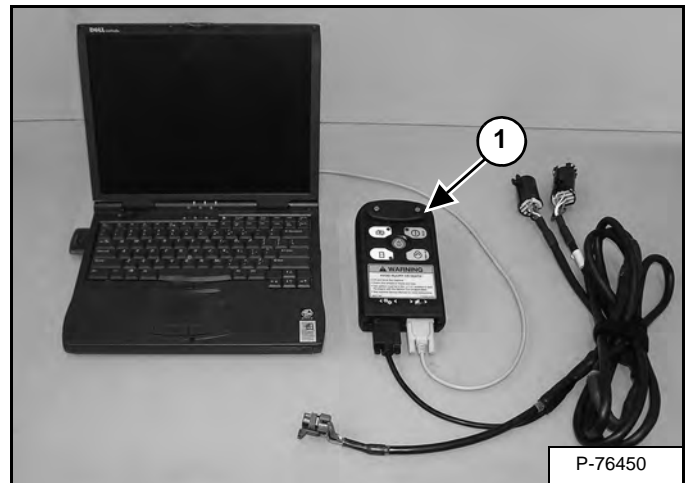

The Remote Start Tool (Service Tool) (Item 1) [Figure 10-61-8] is required when the operator cab is in the raised position for service and the service technician needs to turn on the loader or start the engine. Example: adjusting the steering linkage.

Lift and block the loader.

Raise the lift arms (if required by the procedure) and install an approved lift arm support device.

Raise the operator cab (if required by the procedure).

Open the rear door of the loader.

REMOTE START TOOL (SERVICE TOOL) KIT - 7217666 (CONT'D)

Remote Start Procedure (Cont'd)

Figure 10-61-9

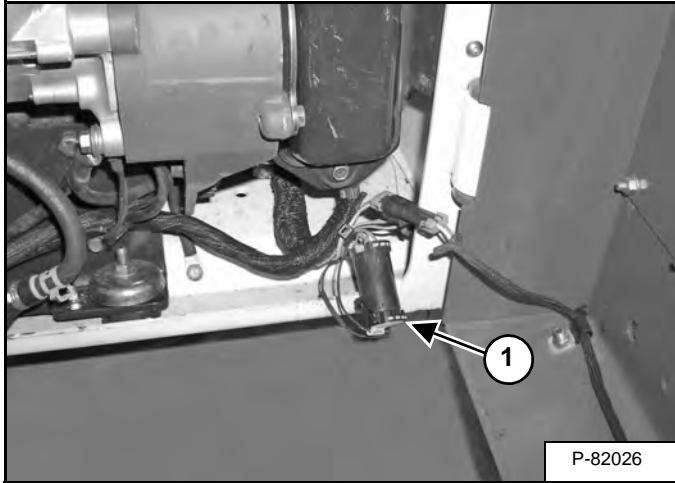

Loaders without an attachment control harness, remove the loader harness cap (Item 1) [Figure 10-61-9] and connect the Loader Service Tool Harness from the Remote Start Tool (Service Tool).

Figure 10-61-10

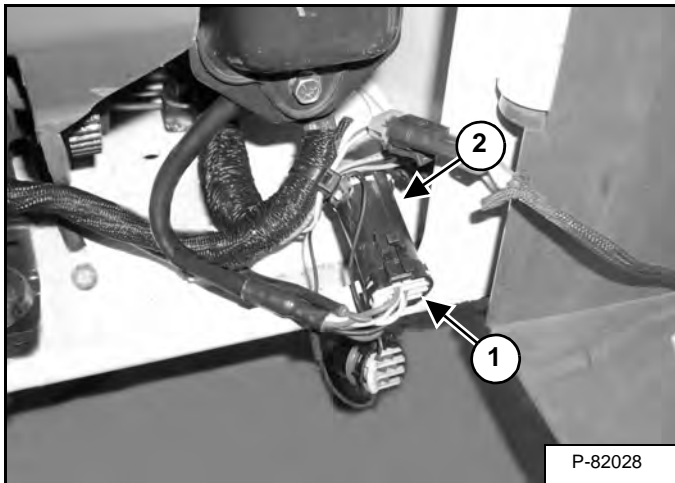

Loaders with an attachment control harness (7 pin or 14 pin), the attachment harness (Item 1) must be disconnected from the loader harness (Item 2) [Figure 10-61-10].

When the remote start procedure is completed, replace the loader connector cap (Item 1) [Figure 10-61-10] or reconnect the attachment control harness to the loader harness [Figure 10-61-10].

Figure 10-61-11

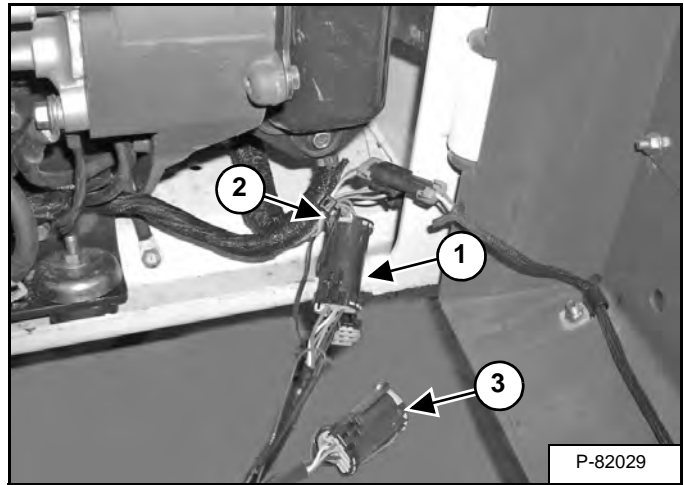

NOTE: The Remote Start Tool (Service Tool) connection harness has two connectors (Item 1) and (Item 3). The main connector (Item 1) [Figure 10-61-11] is always used for connection to the loader harness.

The second connector (Item 3) [Figure 10-61-11] is used for attachment ACD upgrades or attachment operational diagnostics only. This connector has a cap attached to it to prevent damage or corrosion when not in use.

Connect the Remote Start Tool (Service Tool) connector (Item 1) to the loader harness connector (Item 2) and the other Remote Start Tool (Service Tool) connector to the ACD harness connector (Item 3) [Figure 10-61-11].

NOTE: The right instrument panel (Key Switch or Keyless) must be in the off position or the Remote Start Tool (Service Tool) will not operate.

! WARNING

AVOID INJURY OR DEATH

- Lift and block the machine.
- Check that wheels or tracks are clear.
- Cab ignition must be in the “STOP” position to start the engine with the Service Tool (if applicable).
- See machine Service Manual for more instructions.

W-2792-0409

REMOTE START TOOL (SERVICE TOOL) KIT - 7217666 (CONT'D)

Remote Start Procedure (Cont'd)

Figure 10-61-12

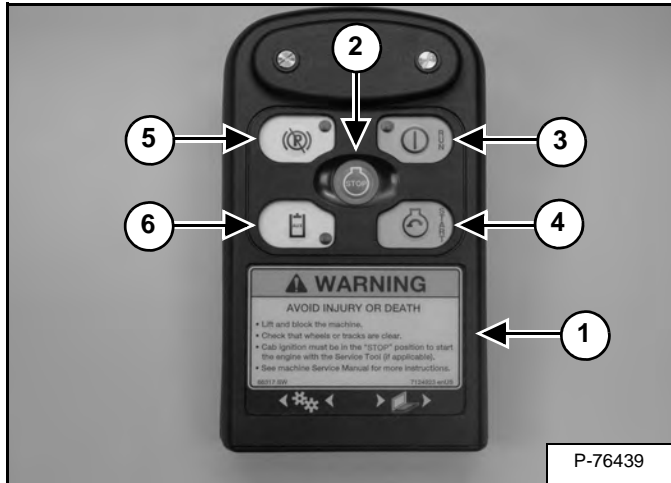

The Remote Start Tool (Service Tool) (Item 1) [Figure 10-61-12] has five buttons.

The STOP button (Item 2) [Figure 10-61-12] is used to stop the Remote Start Tool (Service Tool) from communicating and stop the loader engine.

The RUN button (Item 3) [Figure 10-61-12] is used to turn the Remote Start Tool (Service Tool) on and activates the loader ignition power. The button will illuminate to indicate the service tool is active.

The START button (Item 4) [Figure 10-61-12] is used to start the loader engine.

The traction lock button (Item 5) [Figure 10-61-12] is used to turn traction lock ON or OFF. Push the button and the button will illuminate indicating the traction lock is disabled in which the wheels or tracks are able to turn.

The auxiliary button (Item 6) [Figure 10-61-12] is used to activate the auxiliary hydraulics. The button will illuminate to indicate the auxiliary hydraulics are active. Pressing the button a second time will turn the flow OFF. The button is used when checking pressures and flow rate.

Figure 10-61-13

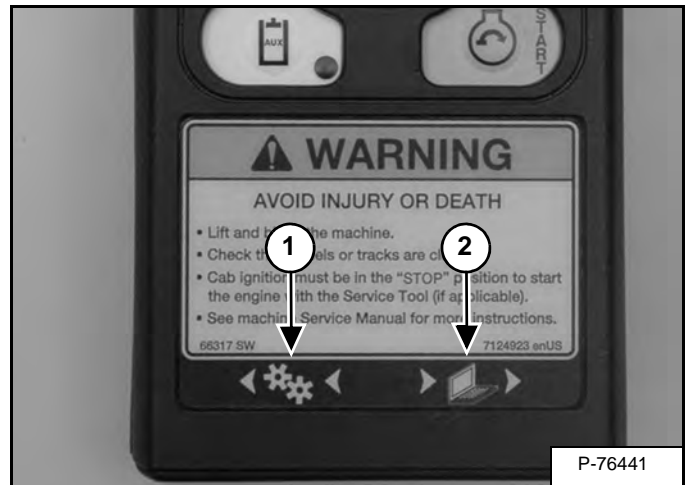

The gear icon with the left facing arrows (Item 1) [Figure 10-61-13] will illuminate and blink when the RUN key is pressed and the loader is communicating with the service tool.

The computer icon with the right facing arrows (Item 2) [Figure 10-61-13] will illuminate and blink when the Remote Start Tool (Service Tool) is transmitting data to and from the computer.

NOTE: To relieve the pressure at the front auxiliaries (if equipped) turn engine off and enable auxiliaries. Move the auxiliary controls left and right to relieve pressure.

Figure 10-61-14

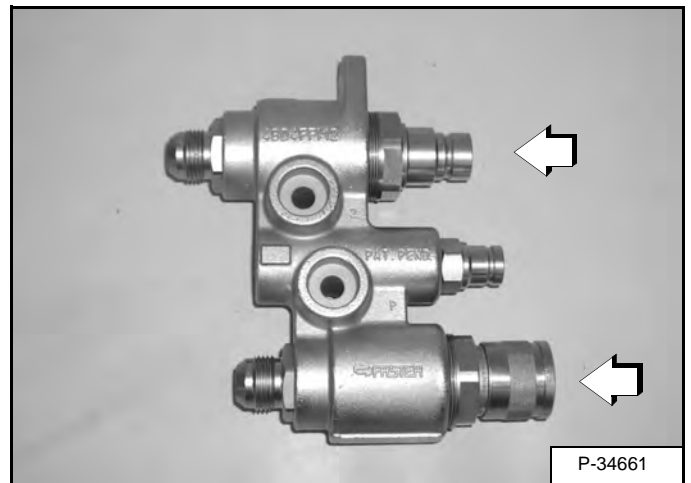

Push the couplers on the front auxiliary block toward the block and hold for five seconds to release the front auxiliary pressure [Figure 10-61-14].



Bobcat®

SERVICE SCHEDULE

Chart

Maintenance work must be done at regular intervals. Failure to do so will result in excessive wear and early failures. The service schedule is a guide for correct maintenance of the Bobcat Loader.

 <b style="font-size: 24pt; margin-left: 10px;">WARNING	<p>Instructions are necessary before operating or servicing machine. Read and understand the Operation & Maintenance Manual, Operator's Handbook and signs (decals) on machine. Follow warnings and instructions in the manuals when making repairs, adjustments or servicing. Check for correct function after adjustments, repairs or service. Untrained operators and failure to follow instructions can cause injury or death.</p> <p style="text-align: right; font-size: 10pt;">W-2003-0807</p>
--	--

SERVICE SCHEDULE		HOURS						
ITEM	SERVICE REQUIRED	8-10	50	100	150	■ 250	■ 500	■ 1000
Engine Oil	Check the oil level and add as needed. Do not overfill.							
Engine Air Filter and Air System	Check condition indicator. Service only when required. Check for leaks and damaged components.							
Engine Cooling System	Clean debris from oil cooler, radiator and e. Check coolant level COLD and add premixed coolant as needed.							
Fuel Filter	Remove the trapped water.							
Lift Arms, Cylinders, Bob-Tach Pivot Pins and Wedges	Lubricate with multipurpose lithium based grease.							
Tires	Check for damaged tires and correct air pressure. Inflate to MAXIMUM pressure shown on sidewall of tire.							
Seat Bar, Control Interlocks, Seat Belt	Check the condition of seat belt. Check the seat bar and control interlocks for correct operation. Clean dirt and debris from moving parts.							
Front Horn / Back-up Alarm	Check for proper function.							
Bobcat Interlock Control Systems (BICST™)	Check for correct function. Lift and Tilt functions MUST NOT operate with seat bar raised. See details in this Manual.							
Safety Signs and Safety Treads	Check for damaged signs (decals) and safety treads. Replace any signs or safety treads that are damaged or worn.							
Operator Cab	Check the fastening bolts, washers and nuts. Check the condition of the cab.							
Indicators and Lights	Check for correct operation of all indicators and lights.							
Heater Filter (If Equipped)	Clean or replace filter as needed.							
Hydraulic Fluid, Hoses and Tubelines	Check fluid level and add as needed. Check for damage and leaks. Repair or replace as needed.							
Final Drive Trans. (Chaincase)	Check oil level and add oil as needed.							
Parking Brake, Foot Pedals and Steering Levers	Check for correct operation. Repair or adjust as needed.							
Wheel Nuts	Check for loose wheel nuts and tighten to correct torque. (See TIRE MAINTENANCE in this manual.)	☐						
Battery	Check cables, connections and electrolyte level. Add distilled water as needed.							
Spark Arrester Muffler	Empty Spark Chamber.							
Engine Oil and Filter	Replace oil and filter.		*					
Alternator Belt	Check tension and adjust as needed.							
Fuel Filter	Replace filter element.							
Steering Shaft	Grease fittings.							
Engine / Hydro. Drive Belt	Check for wear or damage. Adjust or replace as needed.		○					
Bobcat Interlock Control System (BICST™)	Check the function of the lift arm bypass control.							
Hydraulic Reservoir Breather Cap	Replace the reservoir breather cap.							
Hyd./Hydro. Filter	Replace the filter element.		●					
Final Drive Trans. (Chaincase)	Replace the fluid.							
Hydraulic Reservoir	Replace the fluid.							
Coolant	Replace the coolant							Every 2 years

- ☐ Check every 8 - 10 hours for the first 50 hours, then as scheduled.
- * First oil and filter change must occur at 50 hours, then as scheduled.
- Inspect new belt after first 50 hours, then as scheduled.
- Replace the hydraulic / hydrostatic filter element after the first 50 hours; thereafter when the transmission warning light comes ON while operating or as scheduled.
- Or every 12 months.

SS SSL S70 iT4 T4-K-0118



Bobcat®

AIR CLEANER SERVICE

Replacing Filter Elements

Figure 10-80-1

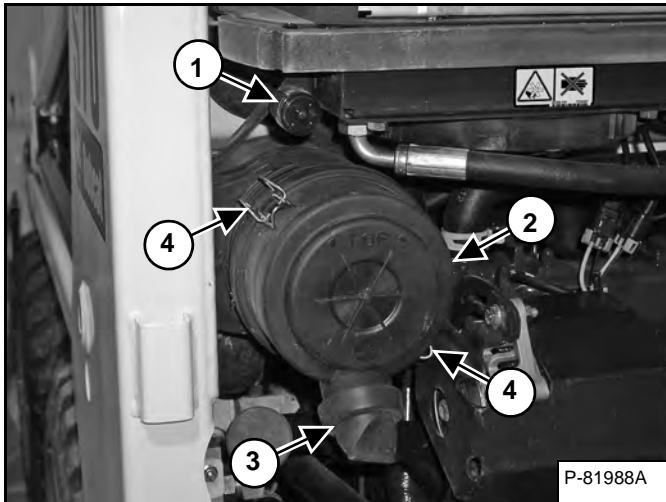

Replace the large (outer) filter element only when the red ring shows in the window of the condition indicator (Item 1) [Figure 10-80-1].

NOTE: Before replacing the filter element, push the button on the condition indicator (Item 1) [Figure 10-80-1]. Start the engine. If the red ring does not show, do not replace the filter element.

Outer Filter

Open the evacuator valve (Item 3) [Figure 10-80-1] to get rid of large particles of dust and dirt.

Remove the dust cover by lifting the lever (Item 4) [Figure 10-80-1].

Figure 10-80-2

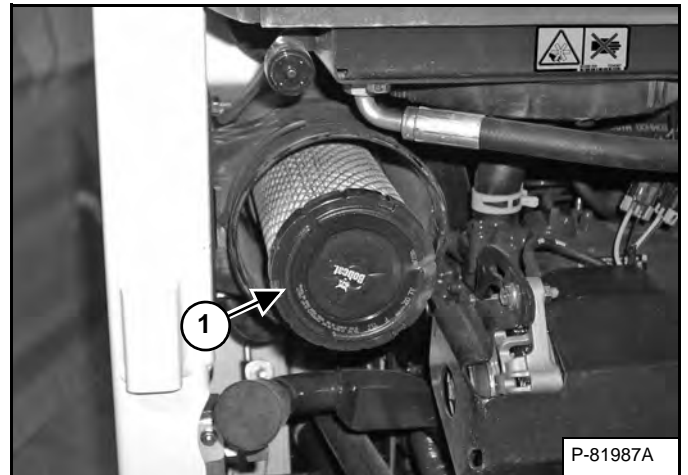

Pull the element straight out (Item 1) [Figure 10-80-2].

Install a new outer element.

Install the dust cover (Item 2) [Figure 10-80-1].

Check the air intake hose and the air cleaner housing for damage. Make sure all connections are tight.

Inner Filter

Replace the inner filter every third time the outer filter is replaced or when the red ring still shows in the indicator window after the outer filter has been replaced.

Figure 10-80-3

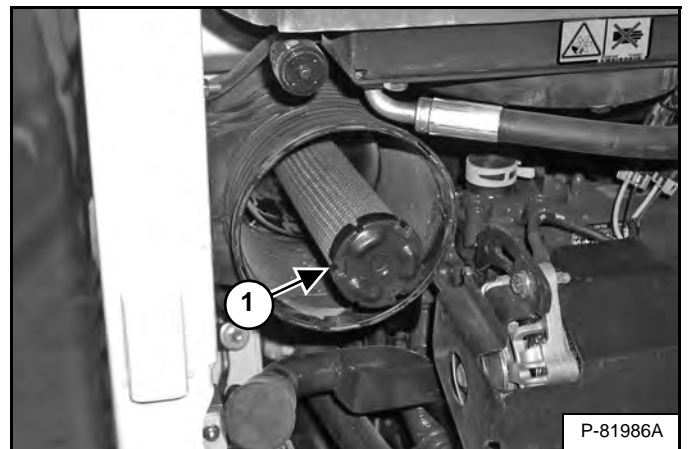

Remove the inner filter (Item 1) [Figure 10-80-3].

NOTE: Make sure all sealing surfaces are free of dirt and debris. Do not use compressed air.

Install a new inner element.

Install the outer element.

Install the dust cover [Figure 10-80-1].



Bobcat®

ENGINE COOLING SYSTEM

Check the cooling system every day to prevent overheating, loss of performance or engine damage.

Cleaning

Open the rear door.

Figure 10-90-1

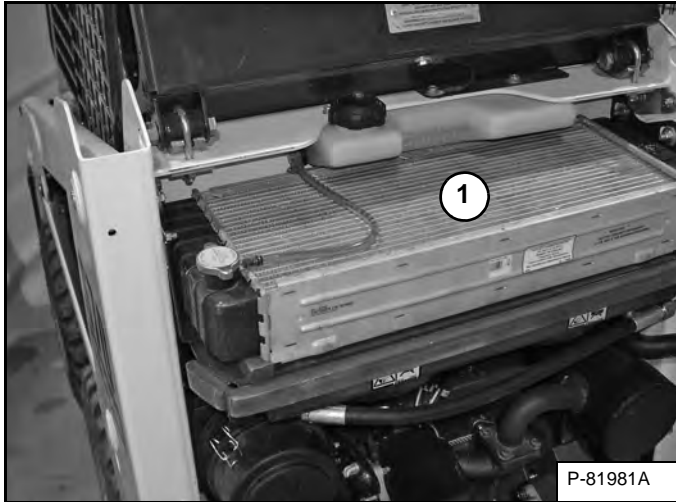

Use low air pressure or water pressure to clean the top of the radiator (Item 1) **[Figure 10-90-1]**.

Check the cooling system for leaks.

Close the rear door.

ENGINE COOLING SYSTEM (CONT'D)

Checking Level

Open the rear door.

! WARNING

AVOID INJURY OR DEATH

Wear safety glasses to prevent eye injury when any of the following conditions exist:

- When fluids are under pressure.
- Flying debris or loose material is present.
- Engine is running.
- Tools are being used.

W-2019-0907

Figure 10-90-2

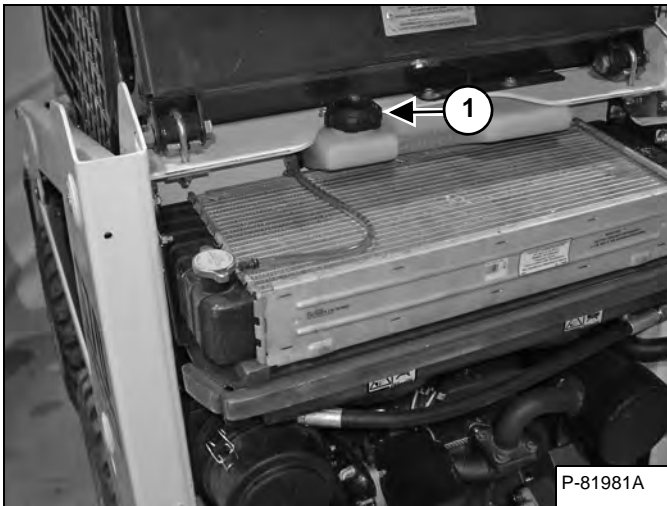

Remove the coolant fill cap (Item 1) [Figure 10-90-2]. Check the coolant level. The level markers are on the tank. Coolant must be at the bottom marker when the engine is cold and on the top marker when hot.

Use a refractometer to check the condition of propylene glycol in your cooling system.

Close the rear door before operating the loader.

IMPORTANT

AVOID ENGINE DAMAGE

Always use the correct ratio of water to antifreeze.

Too much antifreeze reduces cooling system efficiency and may cause serious premature engine damage.

Too little antifreeze reduces the additives which protect the internal engine components; reduces the boiling point and freeze protection of the system.

Always add a premixed solution. Adding full strength concentrated coolant can cause serious premature engine damage.

I-2124-0497

ENGINE COOLING SYSTEM (CONT'D)

Removing And Replacing Coolant

Open the rear door.

Figure 10-90-3

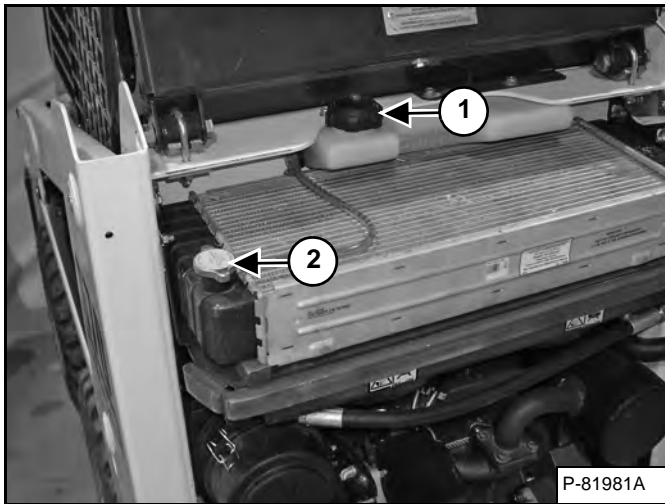

Remove the coolant fill cap (Item 1) [Figure 10-90-3].

Figure 10-90-4

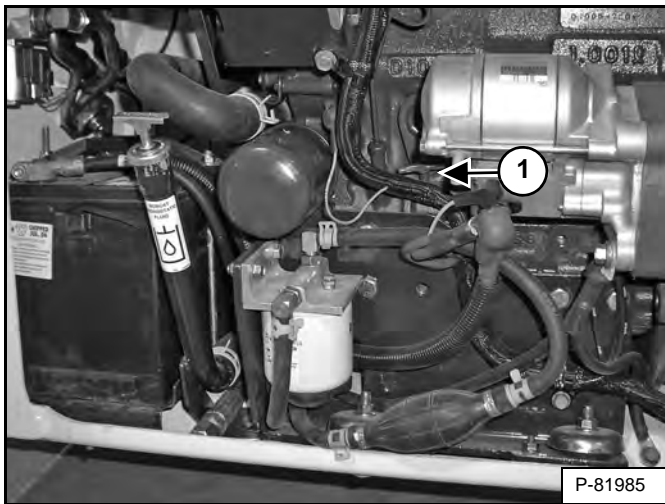

Connect a hose to the engine block drain valve (Item 1) [Figure 10-90-4] (located below the starter). Open the drain valve and drain the coolant into a container.

After all the coolant is removed, close the drain valve and remove the hose.

NOTE: Fluids such as engine oil, hydraulic fluid, coolant, etc. must be disposed of in an environmentally safe manner. Some regulations require that certain spills and leaks on the ground must be cleaned in a specific manner. See local, state and federal regulations for correct disposal.

Mix the coolant in a separate container. (See Capacities on Page SPEC-10-6.) Use 53% propylene glycol and 47% water.

NOTE: The loader is factory filled with propylene glycol coolant (purple color). DO NOT mix propylene glycol with ethylene glycol.

Remove the radiator cap (Item 2) [Figure 10-90-3] and fill the radiator with premixed coolant, 47% water and 53% propylene glycol. Reinstall the radiator cap.

The correct mixture of coolant to provide a -37°C (-34°F) freeze protection is 5 L propylene glycol mixed with 4,4 L of water OR 1 U.S. gal propylene glycol mixed with 3.5 qt of water.

Fill the recovery tank with premixed coolant until it is at the lower marker on the tank.

Use a refractometer to check the condition of propylene glycol in your cooling system and replace the coolant fill cap (Item 1) [Figure 10-90-3].

Run the engine until it is at operating temperature. After stopping the engine, let it cool down and check the coolant level again. Add coolant as needed.

Close the rear door.

IMPORTANT

AVOID ENGINE DAMAGE

Always use the correct ratio of water to antifreeze.

Too much antifreeze reduces cooling system efficiency and may cause serious premature engine damage.

Too little antifreeze reduces the additives which protect the internal engine components; reduces the boiling point and freeze protection of the system.

Always add a premixed solution. Adding full strength concentrated coolant can cause serious premature engine damage.

I-2124-0497



Bobcat®

FUEL SYSTEM

Fuel Specifications

NOTE: Contact your local fuel supplier to receive recommendations for your region.

At a minimum, low sulfur diesel fuel must be used in this machine. Low sulfur is defined as 500 mg/kg (500 ppm) sulfur maximum.

U.S. Standard (ASTM D975)

Use only clean, high quality diesel fuel, Grade Number 2-D or Grade Number 1-D.

Ultra low sulfur diesel fuel may also be used in this machine. Ultra low sulfur is defined as 15 mg/kg (15 ppm) sulfur maximum.

The following is one suggested blending guideline that should prevent fuel gelling during cold temperatures:

TEMPERATURE	GRADE 2-D	GRADE 1-D
Above -9°C (+15°F)	100%	0%
Down to -21°C (-5°F)	50%	50%
Below -21°C (-5°F)	0%	100%

NOTE: Biodiesel blend fuel may also be used in this machine. Biodiesel blend fuel must contain no more than five percent biodiesel mixed with ultra low sulfur petroleum based diesel. This biodiesel blend fuel is commonly marketed as B5 blended diesel fuel. B5 blended diesel fuel must meet ASTM specifications.

E.U. Standard (EN590)

Use only clean, high quality diesel fuel that meets the specifications listed below:

- Low sulfur diesel fuel defined as 500 mg/kg (500 ppm) sulfur maximum.
- Diesel fuel with cetane number of 51.0 and above.

Clean, high quality diesel fuel that meets the EN590 specification may also be used.

NOTE: Biodiesel blend fuel may also be used in this machine. Biodiesel blend fuel must contain no more than seven percent biodiesel mixed with ultra low sulfur petroleum based diesel. This biodiesel blend fuel is commonly marketed as B7 blended diesel fuel. B7 blended diesel fuel must meet EN590 specifications.

Biodiesel Blend Fuel

Biodiesel blend fuel has unique qualities that should be considered before using in this machine:

- Cold weather conditions can lead to plugged fuel system components and hard starting.
- Biodiesel blend fuel is an excellent medium for microbial growth and contamination which can cause corrosion and plugging of fuel system components.
- Use of biodiesel blend fuel may result in premature failure of fuel system components, such as plugged fuel filters and deteriorated fuel lines.
- Shorter maintenance intervals may be required, such as cleaning the fuel system and replacing fuel filters and fuel lines.
- Using biodiesel blended fuels containing more than five percent biodiesel can affect engine life and cause deterioration of hoses, tubelines, injectors, injector pump and seals.

Apply the following guidelines if biodiesel blend fuel is used:

- Ensure the fuel tank is as full as possible at all times to prevent moisture from collecting in the fuel tank.
- Ensure that the fuel tank cap is securely tightened.
- Biodiesel blend fuel can damage painted surfaces, remove all spilled fuel from painted surfaces immediately.
- Drain all water from the fuel filter daily before operating the machine.
- Do not exceed engine oil change interval. Extended oil change intervals can cause engine damage.
- Before vehicle storage; drain the fuel tank, refill with 100% petroleum diesel fuel, add fuel stabilizer and run the engine for at least 30 minutes.

NOTE: Biodiesel blend fuel does not have long term stability and should not be stored for more than three months.

FUEL SYSTEM (CONT'D)

Filling The Fuel Tank

! WARNING

AVOID INJURY OR DEATH

Stop and cool the engine before adding fuel. **NO SMOKING!** Failure to obey warnings can cause an explosion or fire.

W-2063-0807

Figure 10-100-1

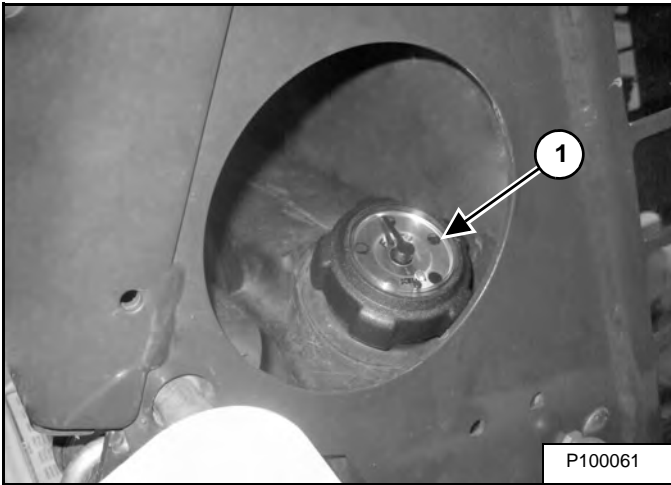

The fuel gauge (Item 1) [Figure 10-100-1] is located on the right side of the loader.

Figure 10-100-2

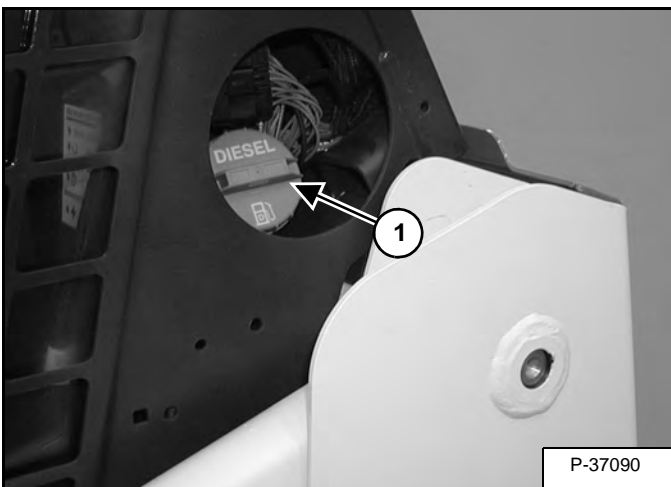

Remove the fill cap (Item 1) [Figure 10-100-2].

Figure 10-100-3

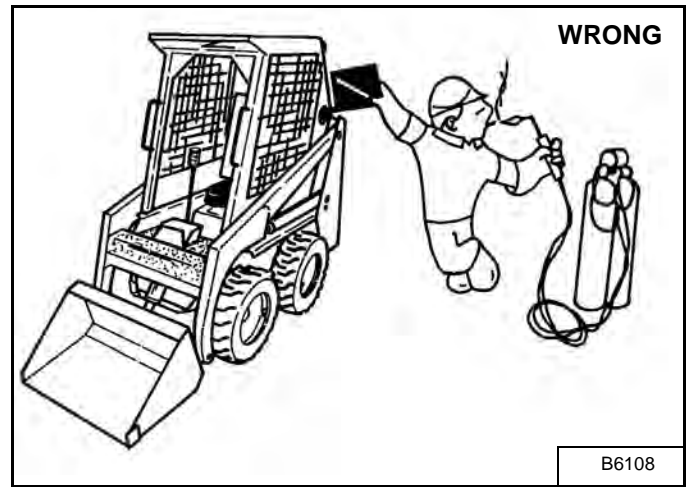

Use a clean, approved safety container to add fuel of the correct specification. Add fuel only in an area that has free movement of air and no open flames or sparks. **NO SMOKING!** [Figure 10-100-3].

Install and tighten the fuel fill cap (Item 1) [Figure 10-100-2].

! WARNING

AVOID INJURY OR DEATH

Always clean up spilled fuel or oil. Keep heat, flames, sparks or lighted tobacco away from fuel and oil. Failure to use care around combustibles can cause explosion or fire.

W-2103-0508

FUEL SYSTEM (CONT'D)

Fuel Filter

For the service interval for removing water from, or replacing the fuel filter. (See SERVICE SCHEDULE on Page 10-70-1.)

Removing Water

Figure 10-100-4

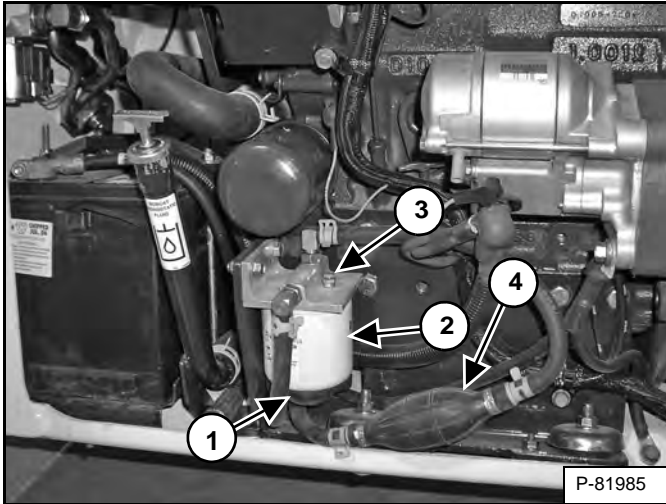

Loosen the drain (Item 1) **[Figure 10-100-4]** at the bottom of the filter element to remove water from the filter.

Replacing Element

Remove the filter element (Item 2) **[Figure 10-100-4]**.

Clean the area around the filter housing. Put clean oil on the seal of the new filter element. Install the fuel filter, and hand tighten.

Remove air from the fuel system. (See Removing Air From The Fuel System below.)

FUEL SYSTEM (CONT'D)

Removing Air From The Fuel System

After replacing the filter element or when the fuel tank has run out of fuel, the air must be removed from the fuel system before starting the engine.

Open the vent (Item 3) [Figure 10-100-4] on the fuel filter housing.

WARNING

AVOID INJURY OR DEATH

Diesel fuel or hydraulic fluid under pressure can penetrate skin or eyes, causing serious injury or death. Fluid leaks under pressure may not be visible. Use a piece of cardboard or wood to find leaks. Do not use your bare hand. Wear safety goggles. If fluid enters skin or eyes, get immediate medical attention from a physician familiar with this injury.

W-2072-0807

Squeeze the hand pump (priming bulb) (Item 4) [Figure 10-100-4] until there are no air bubbles exiting the vent.

Close the vent (Item 3) [Figure 10-100-4] on the fuel filter housing.

With the operator in the seat, seat belt fastened, seat bar lowered and parking brake engaged, start the engine.

NOTE: If the engine fails to start, remove air from the fuel injection pump as follows.

Put jackstands under rear of the frame and raise operator cab. (See OPERATOR CAB on Page 10-30-1.)

Figure 10-100-5

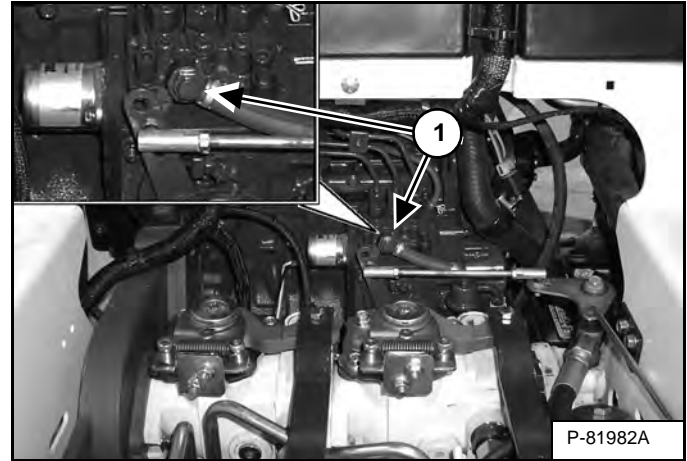

Open the valve (Item 1) [Figure 10-100-5] on the injector pump and squeeze the hand pump (Item 4) [Figure 10-100-4] several times until fuel comes from the valve.

Close the valve.

Lower the operator cab. (See Lowering on Page 10-30-3.)

Remove the jackstands.

ENGINE LUBRICATION SYSTEM

Checking And Adding Engine Oil

Check the engine oil level every day before starting the engine for the work shift.

Figure 10-110-1

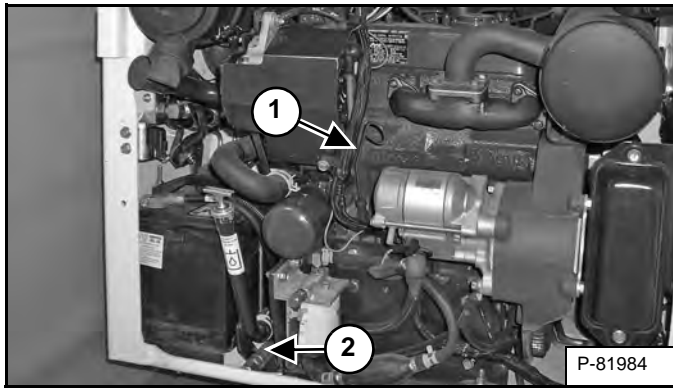

Park the machine on level ground. Open the rear door and remove the dipstick (Item 1) [Figure 10-110-1]. Keep the oil level between the marks on the dipstick. Do not overfill.

Engine Oil Chart

Figure 10-110-2

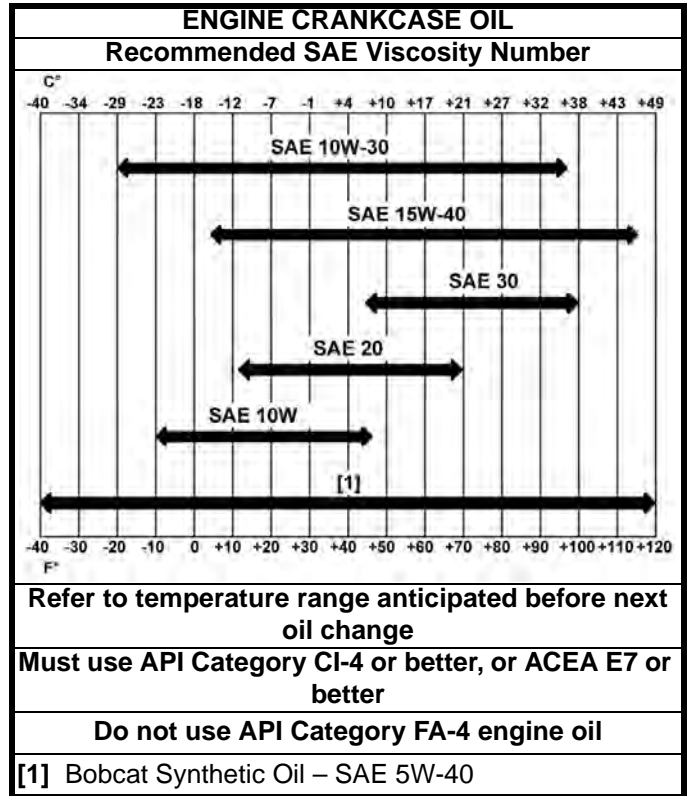

Bobcat engine oils are recommended for use in this machine. If Bobcat engine oil is not available, use a good quality engine oil that meets API Service Category of CI-4 or better, or ACEA E7 or better [Figure 10-110-2].

IMPORTANT

AVOID ENGINE DAMAGE

Use of API Service Category FA-4 engine oil is not approved and may cause irreversible damage to the engine.

I-2384-0916

ENGINE LUBRICATION SYSTEM (CONT'D)

Removing And Replacing Oil And Filter

For the service interval for replacing the engine oil and filter. (See SERVICE SCHEDULE on Page 10-70-1.)

Run the engine until it is at operating temperature. Stop the engine.

Open the rear door and remove the drain hose (Item 2) [Figure 10-110-1] from its storage position.

Figure 10-110-3

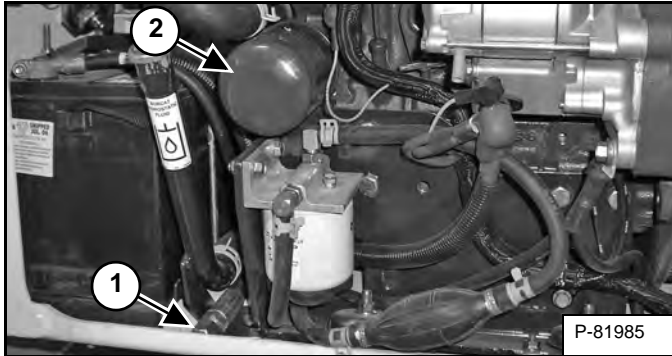

Remove the oil drain cap (Item 1) [Figure 10-110-3] and drain the oil into a container. Recycle or dispose of used oil in an environmentally safe manner.

Remove the oil filter (Item 2) [Figure 10-110-3] and clean the filter housing surface.

Use genuine Bobcat filter only. Put oil on the new filter gasket, install the filter and hand tighten.

Install and tighten the oil drain cap and return the drain hose to the stored position.

Remove the fill cap and put oil in the engine. For the correct quantity (See Capacities on Page SPEC-10-6.). Do not overfill.

Start the engine and let it run for several minutes. Stop the engine and check for leaks at the filter.

Add oil as needed if it is not at the top mark on the dipstick. Install the dipstick and close the rear door.



WARNING

AVOID INJURY OR DEATH

Always clean up spilled fuel or oil. Keep heat, flames, sparks or lighted tobacco away from fuel and oil. Failure to use care around combustibles can cause explosion or fire.

W-2103-0508

HYDRAULIC / HYDROSTATIC SYSTEM

Checking And Adding Fluid

Check the hydraulic / hydrostatic fluid level every day before starting the work shift.

Park the loader on a level surface.

Lower the lift arms and tilt the Bob-Tach® fully back.

Stop the engine and exit the loader. (See STOPPING THE ENGINE AND LEAVING THE LOADER on Page 10-220-1.)

Figure 10-120-1

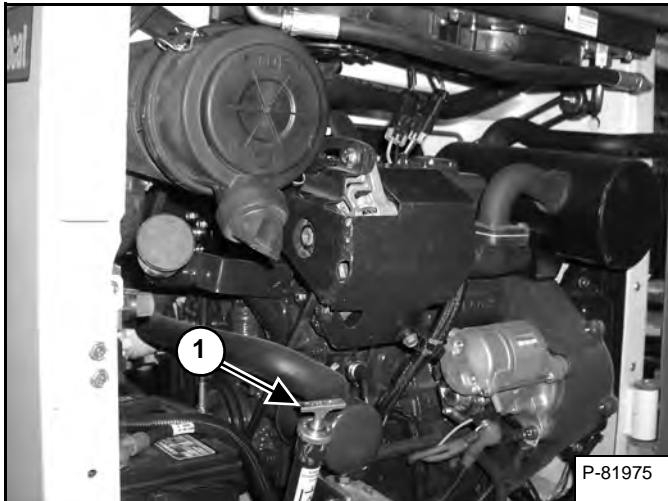

Remove the dipstick (Item 1) [Figure 10-120-1] and allow the oil level to stabilize for 10 - 15 seconds. Install the dipstick and remove to check the fluid level.

NOTE: Hydraulic oil level in the dipstick tube must be allowed to stabilize before it is checked or the dipstick may incorrectly indicate a low fluid condition.

If fluid is needed, add fluid through the dipstick / fill tube.

Hydraulic / Hydrostatic Fluid Chart

Figure 10-120-2

HYDRAULIC / HYDROSTATIC FLUID RECOMMENDED ISO VISCOSITY GRADE (VG) AND VISCOSITY INDEX (VI)

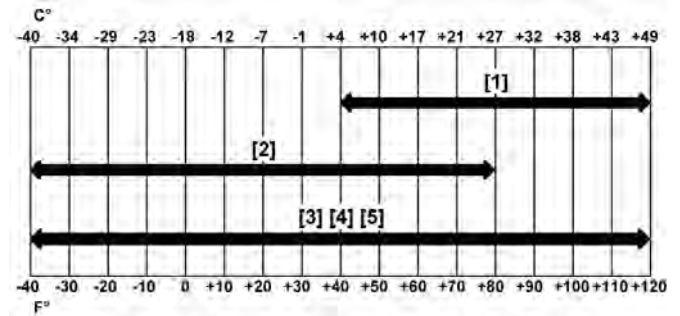

TEMPERATURE RANGE ANTICIPATED DURING MACHINE USE

- [1] VG 100; Minimum VI 130
- [2] VG 46; Minimum VI 150
- [3] BOBCAT All-Season Fluid
- [4] BOBCAT Synthetic Fluid
- [5] BOBCAT Biodegradable Hydraulic / Hydrostatic Fluid (Unlike biodegradable fluids that are vegetable based, Bobcat biodegradable fluid is formulated to prevent oxidation and thermal breakdown at operating temperatures.)

Use only recommended fluid in the hydraulic system [Figure 10-120-2]. (See Hydraulic System on Page SPEC-10-5.)

HYDRAULIC / HYDROSTATIC SYSTEM (CONT'D)

Removing And Replacing Hydraulic Fluid

For the correct service interval. (See SERVICE SCHEDULE on Page 10-70-1.)

Replace the fluid if it becomes contaminated or after major repair.

Always replace the hydraulic / hydrostatic filter whenever the hydraulic fluid is replaced. (See Checking And Adding Fluid on Page 10-120-1.) and (See Capacities on Page SPEC-10-6.).

Figure 10-120-3

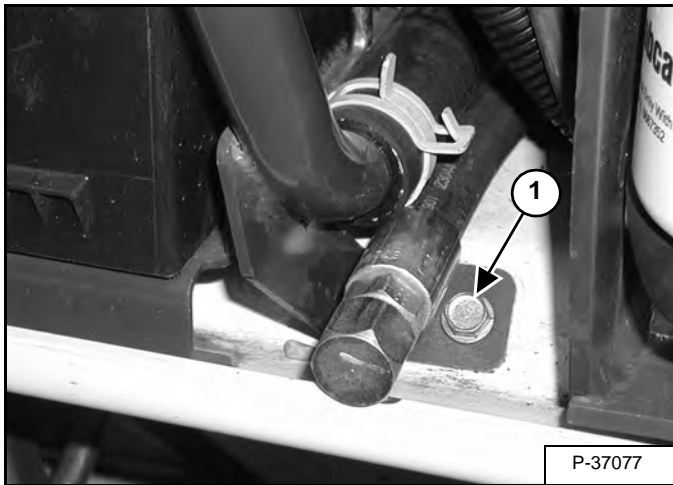

Remove the bolt (Item 1) [Figure 10-120-3] from the dipstick / fill tube mounting bracket.

Figure 10-120-4



Remove the dipstick from the hydraulic fill tube and rotate the tube down into a container [Figure 10-120-4] to drain the reservoir.

NOTE: Fluids such as engine oil, hydraulic fluid, coolant, etc. must be disposed of in an environmentally safe manner. Some regulations require that certain spills and leaks on the ground must be cleaned in a specific manner. See local, state and federal regulations for correct disposal.

After the hydraulic fluid is completely drained, rotate the hydraulic fill tube back to the original position and reinstall the bolt (Item 1) [Figure 10-120-3] to the fill tube mounting bracket.

Fill the hydraulic system with the correct amount and type of hydraulic fluid. (See Hydraulic / Hydrostatic Fluid Chart on Page 10-120-1.) and (See Capacities on Page SPEC-10-6.).

HYDRAULIC / HYDROSTATIC SYSTEM (CONT'D)

Removing And Replacing Hydraulic / Hydrostatic Filter

For the correct service interval (See SERVICE SCHEDULE on Page 10-70-1.).

Stop the engine and exit the loader. (See STOPPING THE ENGINE AND LEAVING THE LOADER on Page 10-220-1.)

Raise the operator cab. (See Raising on Page 10-30-2.)

Figure 10-120-5

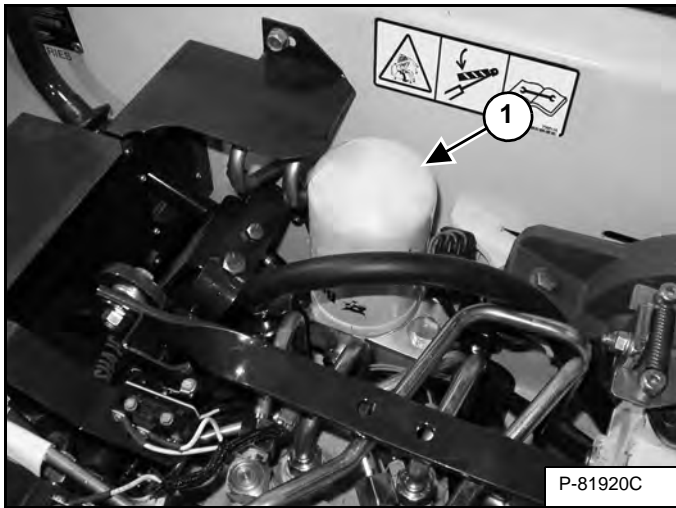

Remove the filter (Item 1) [Figure 10-120-5].

Clean the surface of the filter housing where the filter seal contacts the housing.

Put clean oil on the seal of the new filter element. Install and hand tighten the filter element.

WARNING

AVOID INJURY OR DEATH

Always clean up spilled fuel or oil. Keep heat, flames, sparks or lighted tobacco away from fuel and oil. Failure to use care around combustibles can cause explosion or fire.

W-2103-0508

Lower the operator cab. (See Lowering on Page 10-30-3.)

Start the engine and operate the loader hydraulic controls.

Stop the engine and exit the loader. (See STOPPING THE ENGINE AND LEAVING THE LOADER on Page 10-220-1.)

Check for leaks at the filter.

WARNING

AVOID INJURY OR DEATH

Diesel fuel or hydraulic fluid under pressure can penetrate skin or eyes, causing serious injury or death. Fluid leaks under pressure may not be visible. Use a piece of cardboard or wood to find leaks. Do not use your bare hand. Wear safety goggles. If fluid enters skin or eyes, get immediate medical attention from a physician familiar with this injury.

W-2072-0807

Check fluid level and add as needed. (See Checking And Adding Fluid on Page 10-120-1.)

HYDRAULIC / HYDROSTATIC SYSTEM (CONT'D)

Breather Cap

Replace the breather cap at the correct service interval.
(See SERVICE SCHEDULE on Page 10-70-1.)

Raise the cab. (See Raising on Page 10-30-2.)

Figure 10-120-6

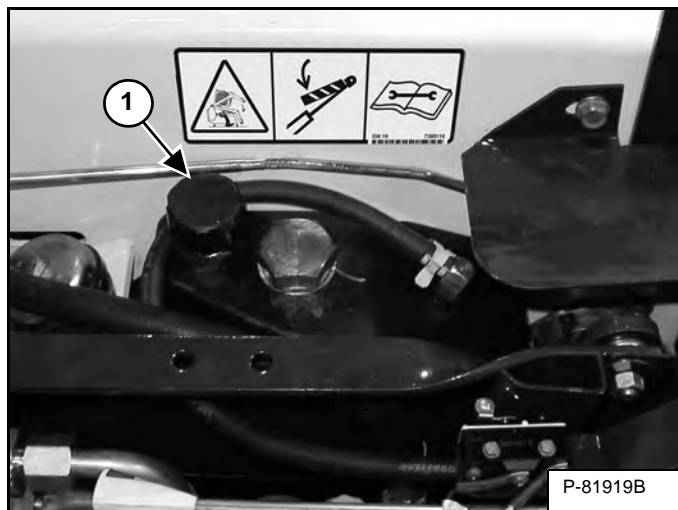

Thoroughly clean the area around the breather cap.

Remove the breather cap (Item 1) **[Figure 10-120-6]** and discard.

Install new breather cap.

Lower the cab. (See Lowering on Page 10-30-3.)

FINAL DRIVE TRANSMISSION (CHAINCASE)

Checking And Adding Oil

The chaincase contains the final drive sprockets and chains. Use the same type of oil as the hydraulic / hydrostatic system. (See Hydraulic System on Page SPEC-10-5.)

Park the loader on a level surface.

Stop the engine and exit the loader. (See Procedure on Page 10-220-1.)

Install jackstands under the rear corners of the loader frame.

Enter the loader and raise the loader lift arms. Install the Lift Arm Support Device. (See Installing on Page 10-20-1.)

Stop the engine and exit the loader. (See Procedure on Page 10-220-1.)

Figure 10-130-1

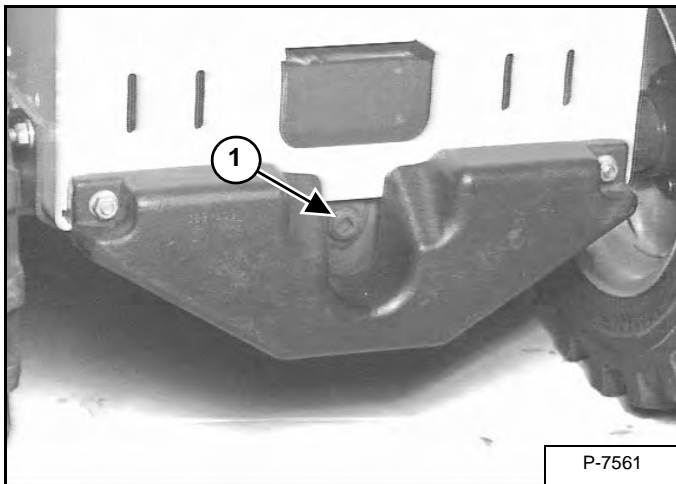

Remove the check plug (Item 1) [Figure 10-130-1] from the front of the chaincase housing.

If oil can be reached with the tip of your finger through the hole, the oil level is correct.

If the level is low, add lubricant through the check plug hole until it reaches the desired level.

Install and tighten the plug.

Lower the lift arms. (See LIFT ARM SUPPORT DEVICE on Page 10-20-1.)

Remove jackstands.

Removing And Replacing Oil

Park the loader on a level surface.

Stop the engine and exit the loader. (See STOPPING THE ENGINE AND LEAVING THE LOADER on Page 10-220-1.)

Install jackstands under the rear corners of the loader frame.

Enter the loader and raise the loader lift arms. Install the Lift Arm Support Device. (See LIFT ARM SUPPORT DEVICE on Page 10-20-1.)

Stop the engine and exit the loader. (See STOPPING THE ENGINE AND LEAVING THE LOADER on Page 10-220-1.)

Remove the check plug (Item 1) [Figure 10-130-1] from the front of the chaincase housing.

Figure 10-130-2



Use a pump to suction the oil from the chaincase [Figure 10-130-2].

Recycle or dispose of the used oil in an environmentally safe manner.

Add new oil until the oil flows from the hole.

Install and tighten the plug.

Lower the lift arms. (See LIFT ARM SUPPORT DEVICE on Page 10-20-1.)

Remove jackstands.



Bobcat®

AUXILIARY CONTROL LOCKBOLT

Procedure

Figure 10-140-1

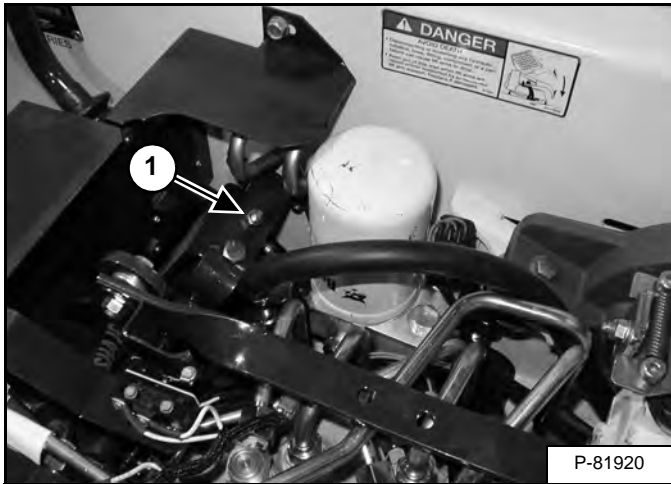

The Auxiliary control has a lockbolt (Item 1) [Figure 10-140-1] that must be removed to use the optional auxiliary hydraulics.

Raise the operator cab. (See Raising on Page 10-30-2.)

Remove the nut and bolt (Item 1) [Figure 10-140-1] from the right hand steering lever.



Bobcat®

BOB-TACH

Inspection And Maintenance

Figure 10-150-1

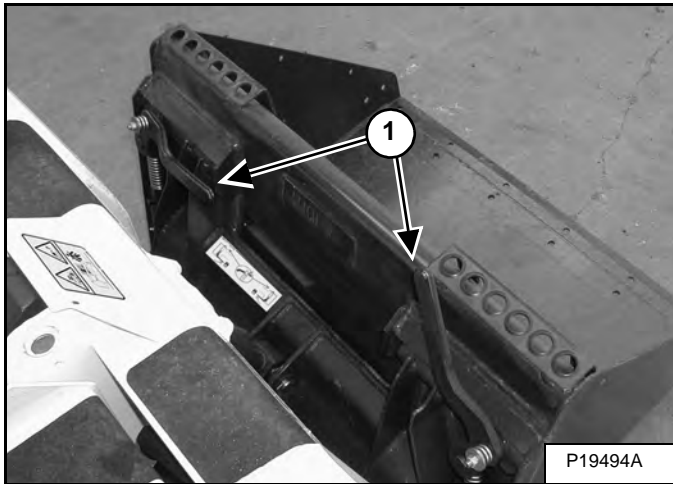

Move the Bob-Tach levers down to engage the wedges [Figure 10-150-1].

The levers and wedges must move freely.

WARNING

AVOID INJURY OR DEATH

The Bob-Tach wedges must extend through the holes in the attachment mounting frame. Levers must be fully down and locked. Failure to secure wedges can allow attachment to come off.

W-2715-0208

Figure 10-150-2

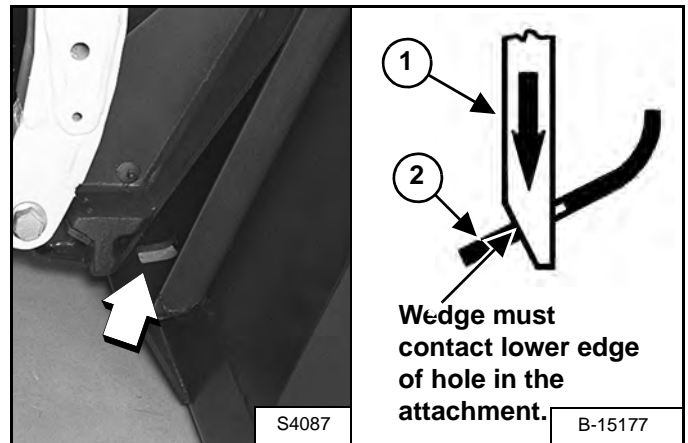

The wedges (Item 1) must extend through the holes in the attachment mounting frame (Item 2) [Figure 10-150-2].

The spring loaded wedge (Item 1) [Figure 10-150-2] must contact the lower edge of the hole in the attachment (Item 2).

If the wedge does not contact the lower edge of the hole [Figure 10-150-2], the attachment will be loose and can come off the Bob-Tach.

Figure 10-150-3

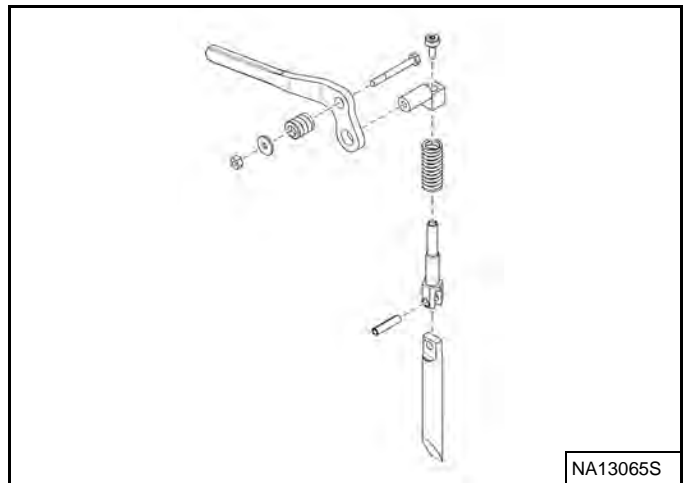

Inspect the mounting frame on the attachment and Bob-Tach, linkages and wedges for excessive wear or damage [Figure 10-150-3]. Replace any parts that are damaged, bent or missing. Keep all fasteners tight.

Look for cracked welds. Contact your Bobcat dealer for repair or replacement parts.

Lubricate the wedges. (See SERVICE SCHEDULE on Page 10-70-1.) and (See LUBRICATING THE LOADER on Page 10-160-1.)



Bobcat®

LUBRICATING THE LOADER

Lubrication Locations

Lubricate the loader as specified for the best performance of the loader. (See SERVICE SCHEDULE on Page 10-70-1.)

Record the operating hours each time you lubricate the Bobcat loader.

Always use a good quality lithium based multi-purpose grease when you lubricate the loader. Apply the lubricant until extra grease shows.

Lubricate the following locations on the loader:

Figure 10-160-1

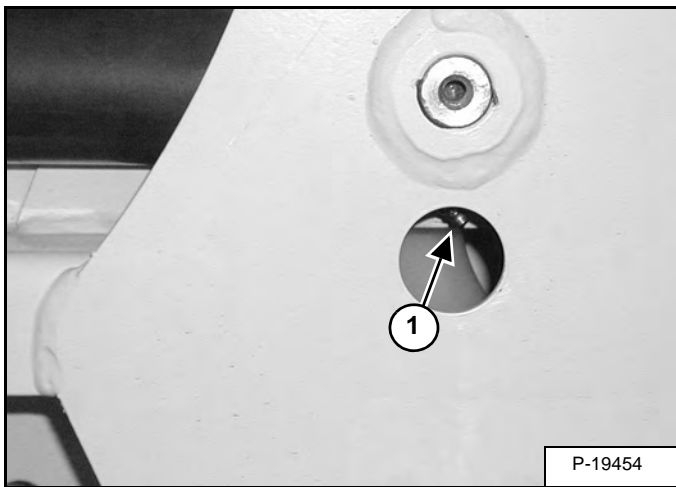

1. Base End Lift Cylinder (Both Sides) [Figure 10-160-1].

Figure 10-160-2

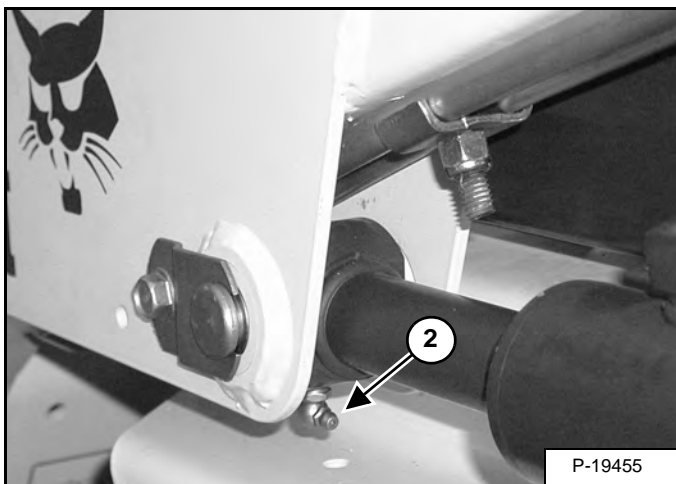

2. Rod End Lift Cylinder (Both Sides) [Figure 10-160-2].

Figure 10-160-3

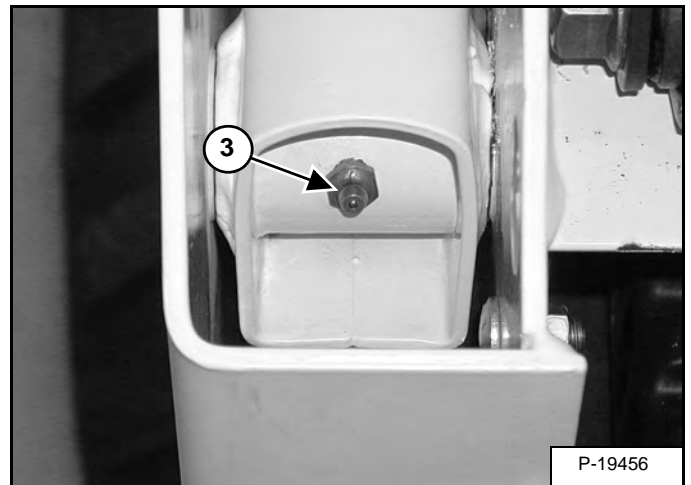

3. Lift Arm Pivot Pin (Both Sides) [Figure 10-160-3].

Figure 10-160-4

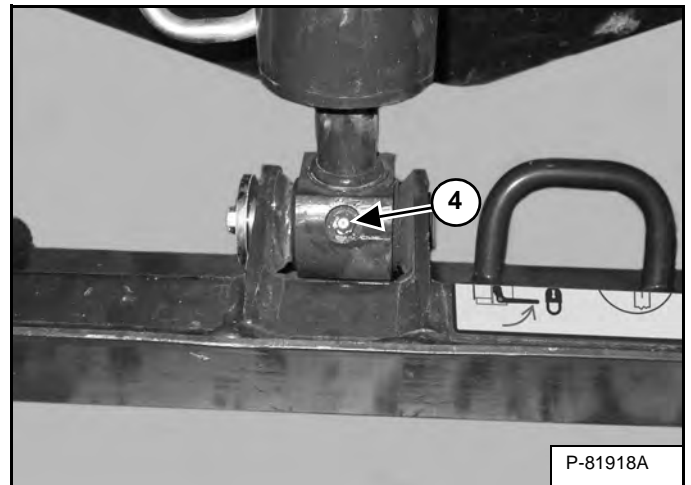

4. Rod End Tilt Cylinder (Item 1) [Figure 10-160-4].

Figure 10-160-5

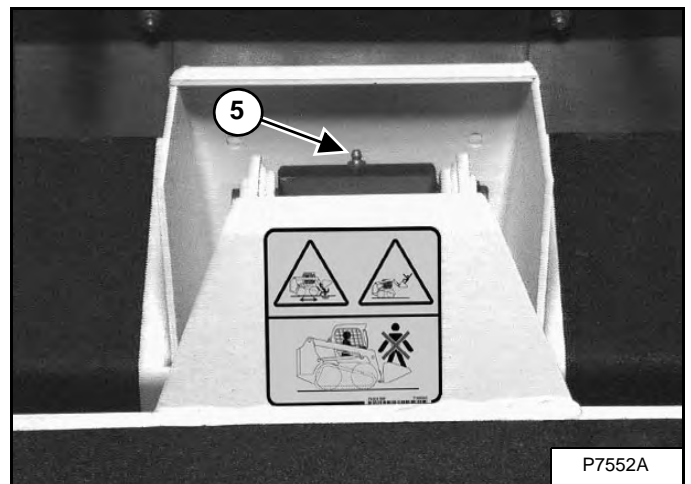

5. Base End Tilt Cylinder [Figure 10-160-5].

LUBRICATING THE BOBCAT LOADER (CONT'D)

Lubrication Locations (Cont'd)

Figure 10-160-6

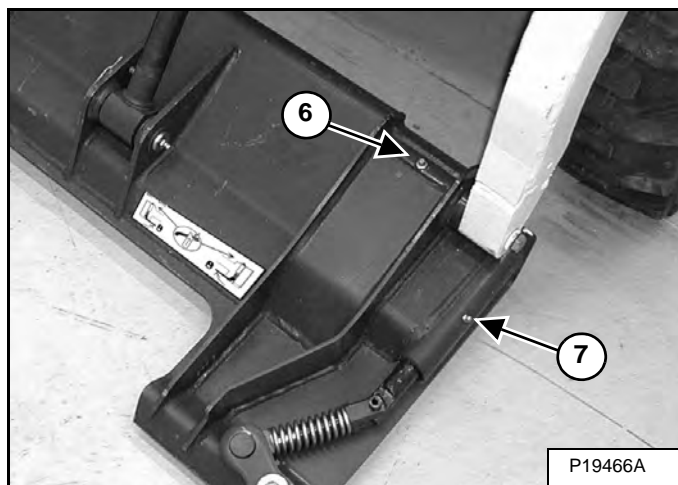

6. Bob-Tach Pivot Pin (Both Sides) [Figure 10-160-6].

7. Bob-Tach Wedge (Both Sides) [Figure 10-160-6].

Figure 10-160-7

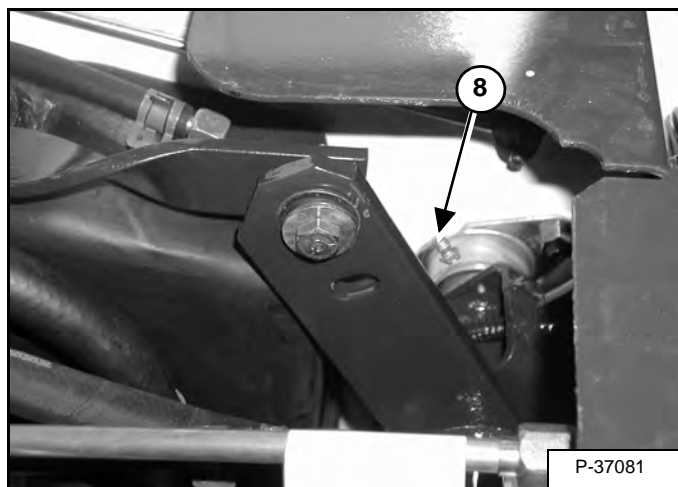

8. 250 Hours: Steering shaft pivot bearings (Both Sides) [Figure 10-160-7].

TIRE MAINTENANCE

Wheel Nuts

Figure 10-170-1



See the SERVICE SCHEDULE for the service interval to check the wheel nuts [Figure 10-170-1]. (See SERVICE SCHEDULE on Page 10-70-1.)

When *installing* wheel nuts, tighten to 217 N•m (160 ft-lb) torque.

When *checking* wheel nut torque, set the torque wrench to 190 N•m (140 ft-lb) to prevent over-tightening.

Rotating

Check the tires regularly for wear, damage and pressure. Inflate tires to the maximum pressure shown on the sidewall of the tire.

Figure 10-170-2

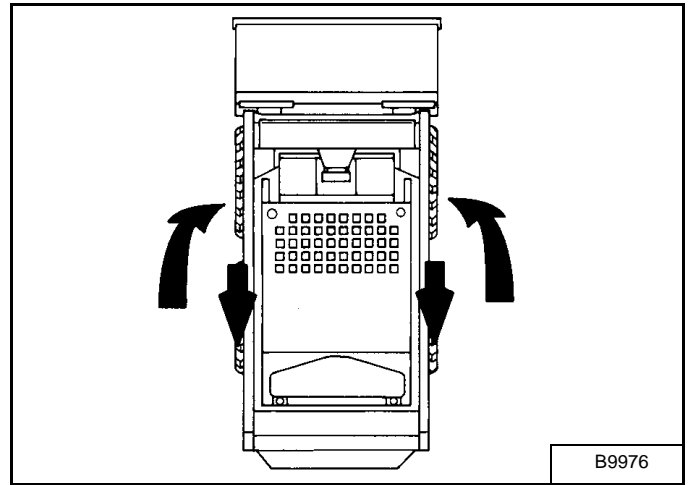

Rear tires usually wear faster than front tires. To keep tire wear even, move the front tires to the rear and rear tires to the front [Figure 10-170-2].

It is important to keep all tires the same size. If different sizes are used, each tire will be turning at a different rate and cause excessive wear. The tread bars of all the tires must face the same direction.

Recommended tire pressure must be maintained to avoid excessive tire wear and loss of stability and handling capability. Check for the correct pressure before operating the loader.

TIRE MAINTENANCE (CONT'D)

Mounting

Tires are to be repaired only by an authorized person using the proper procedures and safe equipment.

Tires and rims must always be checked for correct size before mounting. Check rim and tire bead for damage.

The rim flange must be cleaned and free of rust.

The tire bead and rim flange must be lubricated with a rubber lubricant before mounting the tire.

Avoid excessive pressure which can rupture the tire and cause serious injury or death.

During inflation of the tire, check the tire pressure frequently to avoid over inflation.



WARNING

AVOID INJURY OR DEATH

Do not inflate tires above specified pressure. Failure to use correct tire mounting procedure can cause an explosion which can result in injury or death.

W-2078-1007

IMPORTANT

Inflate tires to the MAXIMUM pressure shown on the sidewall of the tire. DO NOT mix brands of tires used on the same machine.

I-2057-1010

SPARK ARRESTER MUFFLER

Cleaning Procedure

See the SERVICE SCHEDULE for service interval for cleaning the spark arrester muffler. (See SERVICE SCHEDULE on Page 10-70-1.)

Do not operate the loader with a defective exhaust system.

IMPORTANT

This machine is factory equipped with a U.S.D.A. Forestry Service approved spark arrester exhaust system.

The spark arrester muffler, if equipped, must be cleaned to keep it in working condition. The spark arrester muffler must be serviced by dumping the spark chamber every 100 hours of operation.

On some models, the turbocharger functions as the spark arrester and must operate correctly for proper spark arrester function.

If this machine is operated on flammable forest, brush, or grass covered land, it must be equipped with a spark arrester attached to the exhaust system and maintained in working order. Failure to do so will be in violation of California State Law, Section 4442. PRC. Refer to local laws and regulations for spark arrester requirements.

I-2284-0111

Stop the engine and open the rear door.

Figure 10-180-1

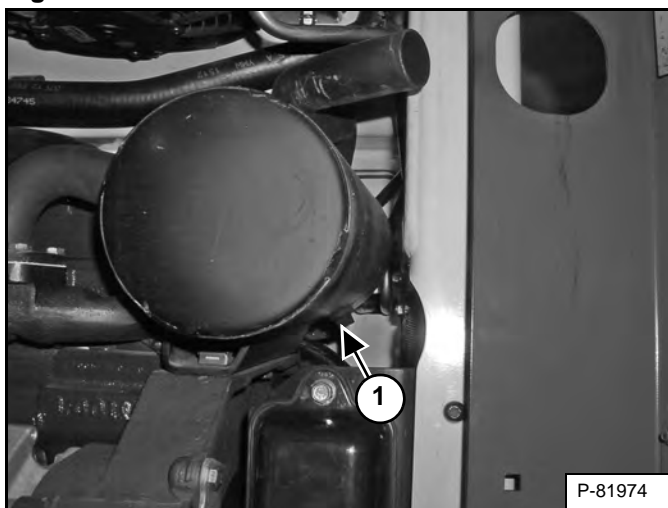

Remove the plug (Item 1) [Figure 10-180-1] from the bottom of the muffler.

! WARNING

When the engine is running during service, the driving and steering controls must be in neutral and the parking brake engaged. Failure to do so can cause injury or death.

W-2006-1209

Start the engine and run for about 10 seconds while a second person, wearing safety goggles, holds a piece of wood over the outlet of the muffler. This will force contaminants out through the cleanout hole.

Stop the engine.

Install and tighten the plug.

Close the rear door.

! WARNING

AVOID INJURY OR DEATH

When an engine is running in an enclosed area, fresh air must be added to avoid concentration of exhaust fumes. If the engine is stationary, vent the exhaust outside. Exhaust fumes contain odorless, invisible gases which can kill without warning.

W-2050-0807

! WARNING

Stop engine and allow the muffler to cool before cleaning the spark chamber. Wear safety goggles. Failure to obey can cause serious injury.

W-2011-1285

! WARNING

Never use machine in atmosphere with explosive dust or gases or where exhaust can contact flammable material. Failure to obey warnings can cause injury or death.

W-2068-1285



Bobcat®

PIVOT PINS

Inspection And Maintenance

Figure 10-190-1

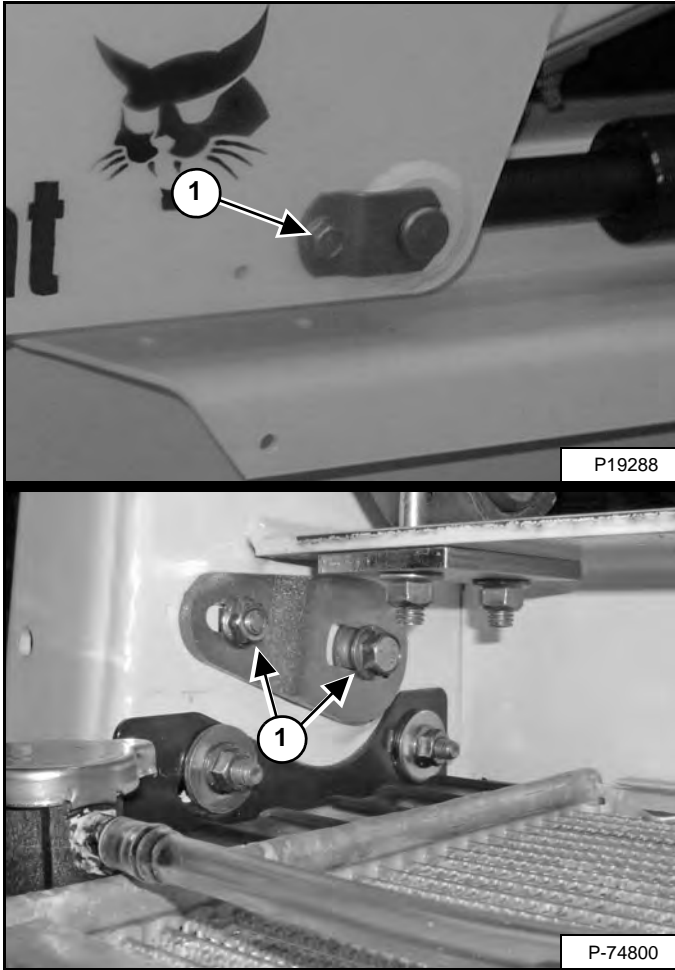

All lift arm and cylinder pivots have a large pin held in position with a retainer bolt and locknut (Item 1) [Figure 10-190-1].

Figure 10-190-2

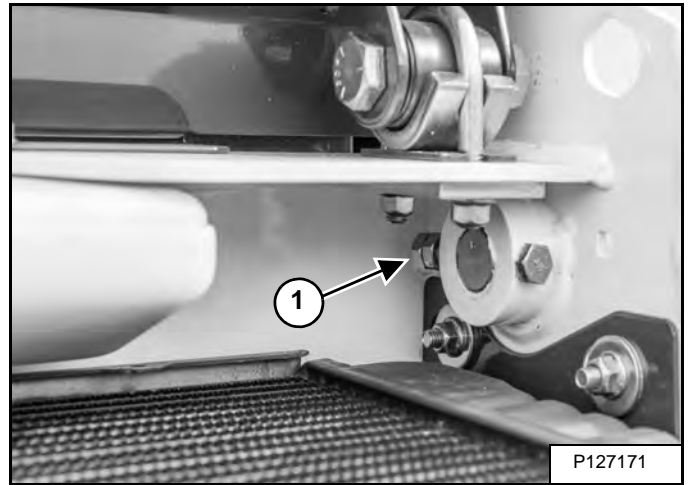

Some pivot pins use a bolt with double nut (Item 1) [Figure 10-190-2]. Do not tighten the first nut all the way. Tighten the two nuts together to the specified torque. The bolt should be free to turn.

PIVOT PINS (CONT'D)

Inspection And Maintenance (Cont'd)

Figure 10-190-3

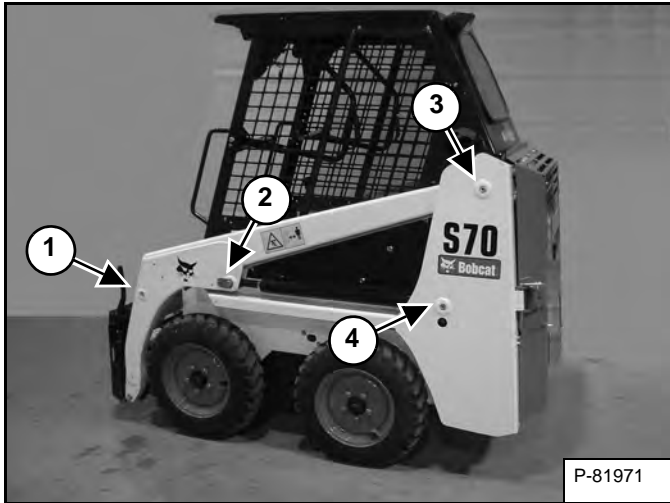
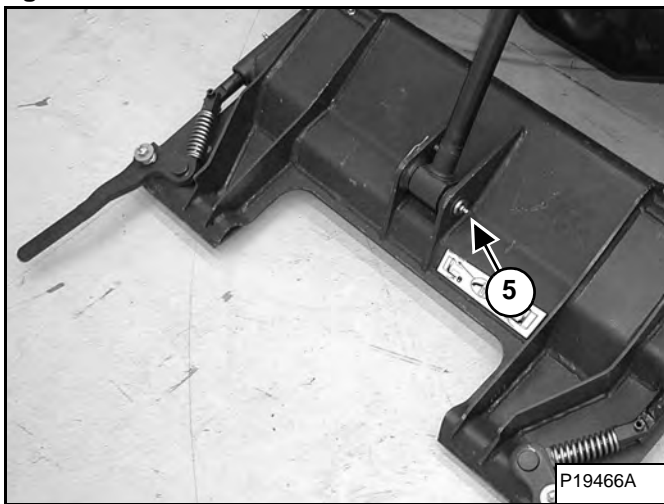

Figure 10-190-4



Check the following pivot pins (Items 1 - 5) [Figure 10-190-3] and [Figure 10-190-4].

Repeat for (Items 1 - 4) [Figure 10-190-3] on the opposite side of the loader.

Tighten to 48 - 54 N•m (35 - 40 ft-lb) torque.

Do not over tighten.

SEAT BAR RESTRAINT SYSTEM

Description

The seat bar restraint system has a pivoting seat bar with armrests.

The operator controls the use of the seat bar. The seat bar in the down position helps to keep the operator in the seat.

The foot pedals have mechanical interlocks for the lift and tilt functions. The mechanical interlocks require the operator to lower the seat bar in order to operate the foot pedal controls.

When the seat bar is down, the PRESS TO OPERATE LOADER button is activated and the engine is running, the lift, tilt and traction drive functions can be operated.

When the seat bar is up, the lift and tilt control pedals are locked when returned to the NEUTRAL position.

Inspecting

Sit in the seat and fasten the seat belt. Engage the parking brake. Pull the seat bar all the way down. Start the engine. Press the PRESS TO OPERATE LOADER button.

Operate the hydraulic controls to check that both the lift and tilt functions operate correctly. Raise the lift arms until the attachment is about 600 mm (2 ft) off the ground.

Raise the seat bar. Move the hydraulic controls. Pedals must be firmly locked in the NEUTRAL position. There must be no motion of the lift arms or tilt (attachment) when the controls are moved.

Lower the seat bar, press the PRESS TO OPERATE LOADER button, lower the lift arms. Operate the lift control. While the lift arms are going up, raise the seat bar. The lift arms must stop.

Lower the seat bar, press the PRESS TO OPERATE LOADER button, lower the lift arms and put the attachment flat on the ground. Stop the engine. Raise the seat bar. Operate the foot pedals to be sure they are firmly locked in the NEUTRAL position.



The seat bar system must deactivate the lift and tilt control functions when the seat bar is up. See your Bobcat dealer for service if hydraulic controls do not deactivate.

W-2465-0111

SEAT BAR RESTRAINT SYSTEM (CONT'D)

Maintaining

See the service schedule for correct service interval.
(See SERVICE SCHEDULE on Page 10-70-1.)

Figure 10-200-1

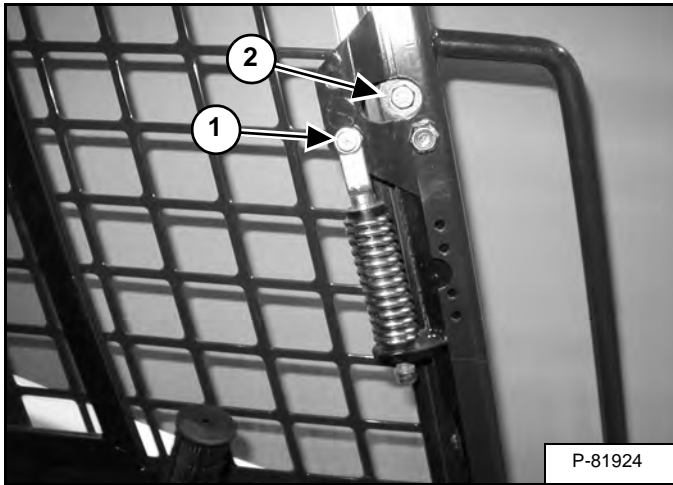
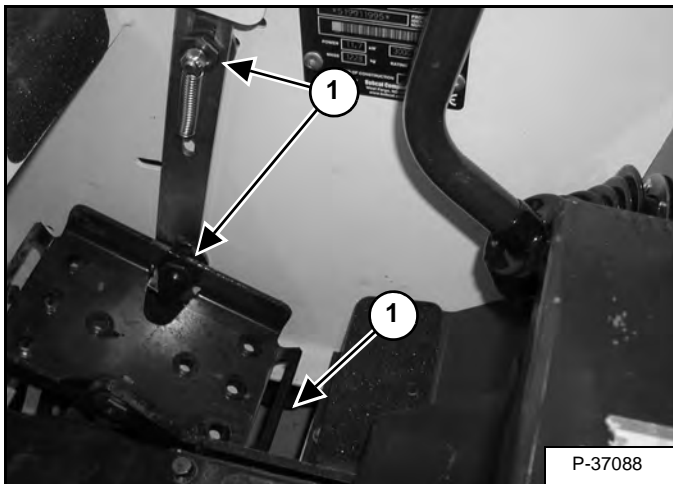

Figure 10-200-2



Use compressed air to clean any debris or dirt from the pivot parts (Item 1) [Figure 10-200-1] and [Figure 10-200-2]. Do not lubricate. Inspect all mounting hardware. The correct bolt torque is 34 - 38 N•m (25 - 28 ft-lb) for the seat bar pivot (Item 2) [Figure 10-200-1].

If the seat bar system does not function correctly, check for free movement of each linkage part. Check for excessive wear. Adjust pedal control linkage. Replace parts that are worn or damaged. Use only genuine Bobcat replacement parts.

LOADER STORAGE AND RETURN TO SERVICE

Storage

Sometimes it may be necessary to store your Bobcat loader for an extended period of time. Below is a list of items to perform before storage.

- Thoroughly clean the loader including the engine compartment.
- Lubricate the loader.
- Replace worn or damaged parts.
- Park the loader in a dry protected shelter.
- Lower the lift arms all the way and put the bucket flat on the ground.
- Put blocks under the frame to remove weight from the tires.
- Put grease on any exposed cylinder rods.
- Put fuel stabilizer in the fuel tank and run the engine a few minutes to circulate the stabilizer to the pump and fuel injectors.
- Drain and flush the cooling system. Refill with premixed coolant.
- Replace all fluids and filters (engine, hyd. / hydro.).
- Replace air cleaner, heater and air conditioning filters.
- Put all controls in neutral position.
- Remove the battery. Be sure the electrolyte level is correct then charge the battery. Store it in a cool dry place above freezing temperatures and charge it periodically during storage.
- Cover the exhaust pipe opening.
- Tag the machine to indicate that it is in storage condition.

Return To Service

After the Bobcat loader has been in storage, it is necessary to follow a list of items to return the loader to service.

- Check the engine and hydraulic oil levels; check coolant level.
- Install a fully charged battery.
- Remove grease from exposed cylinder rods.
- Check all belt tensions.
- Be sure all shields and guards are in place.
- Lubricate the loader.
- Check tire inflation and remove blocks from under frame.
- Remove cover from exhaust pipe opening.
- Start the engine and let run for a few minutes while observing the instrument panels and systems for correct operation.
- Operate machine, check for correct function.
- Stop the engine and check for leaks. Repair as needed.



Bobcat®

STOPPING THE ENGINE AND LEAVING THE LOADER

Procedure

Stop the Bobcat Loader on level ground.

Lower the lift arms fully and put the attachment flat on the ground.

Figure 10-220-1

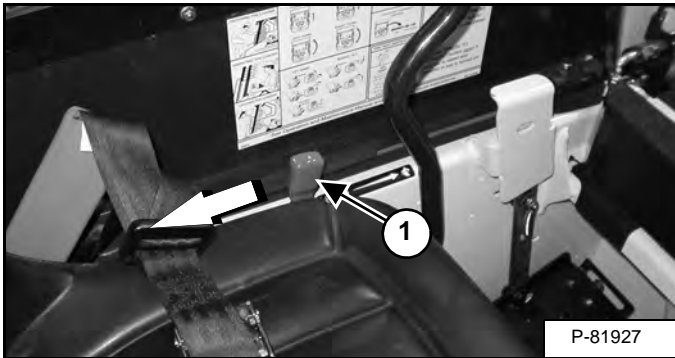

Pull the engine speed control lever (Item 1) [Figure 10-220-1] fully backward to decrease the engine speed.

Figure 10-220-2

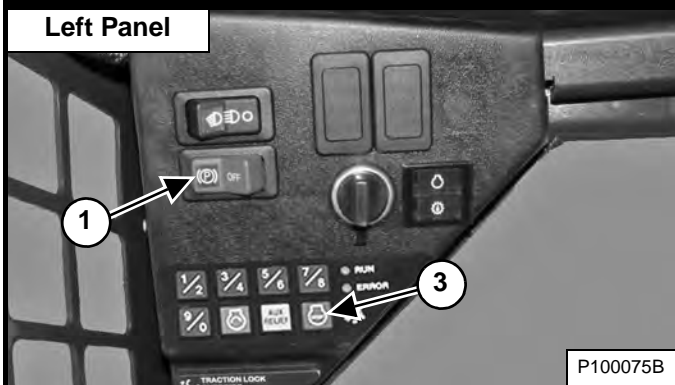
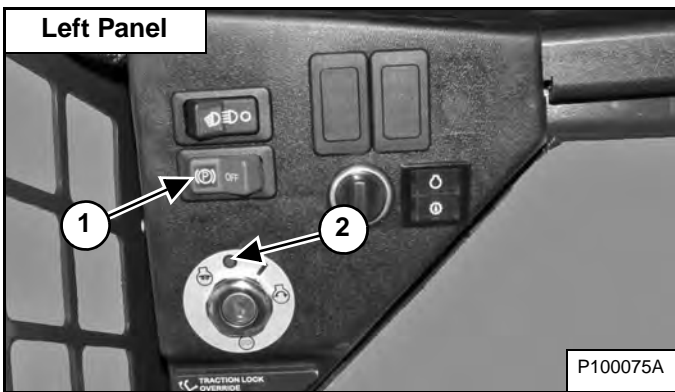

Turn the key switch to the OFF position (Item 2) or press the STOP button (Item 3) [Figure 10-220-2].

Engage the parking brake by pressing the left side of the parking brake switch (Item 1) [Figure 10-220-2].

Raise the seat bar and make sure the lift and tilt functions are deactivated. Move the pedals until they both lock.

Move auxiliary hydraulic control lever out of detent position.

Unbuckle the seat belt.

Remove the key from the switch to prevent operation of the loader by unauthorized personnel. (Standard Key Panel only.)

Figure 10-220-3



Exit the loader using grab handles, safety tread and steps (maintaining a 3-point contact) [Figure 10-220-3].

WARNING

Before you leave the operator's seat:

- Lower the lift arms, put the attachment flat on the ground.
- Stop the engine.
- Engage the parking brake.
- Raise the seat bar, move pedals until both lock.
- Move auxiliary hydraulic control lever out of detent position.

W-2164-0108



Bobcat®

EMERGENCY EXIT

The front opening on the operator cab and rear window provide exits.

Rear Window

Figure 10-230-1

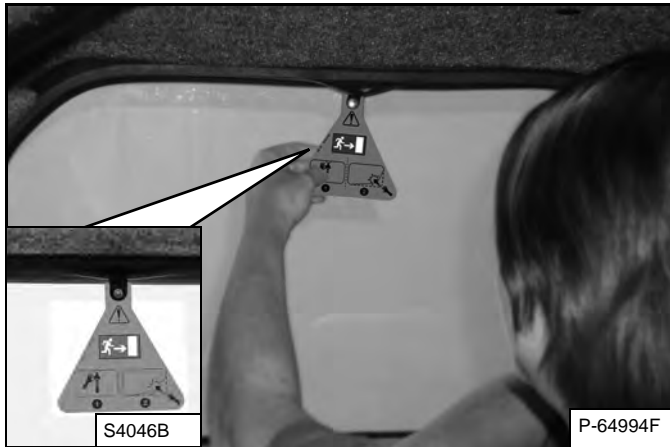

Pull the tag on the top of the rear window [Figure 10-230-1] to remove the rubber cord.

Push the rear window out of the rear of the operator cab.

Figure 10-230-2



Exit through the rear of the operator cab [Figure 10-230-2].

Front Door

This machine may be equipped with a Front Door.

NOTE: When an Operator Cab Enclosure Kit is installed, the window of the front door can be used as an emergency exit [Figure 10-230-3].

NOTE: If the loader has a Special Application Door Kit installed, the window of the front door is NOT an emergency exit.

Figure 10-230-3

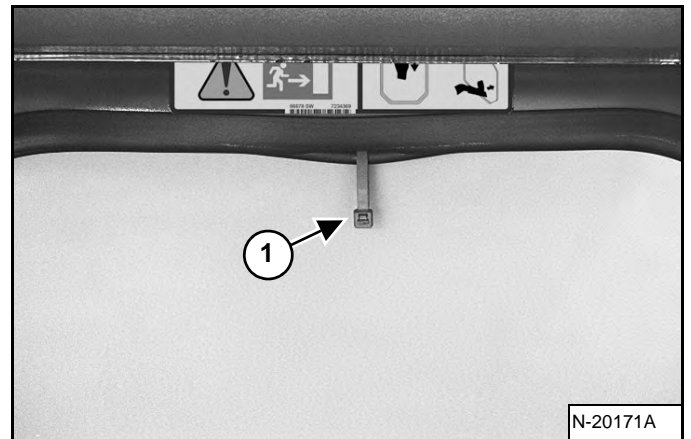

Pull the plastic loop (Item 1) [Figure 10-230-3] at the top of the window in the front door to remove the rubber cord.

Figure 10-230-4

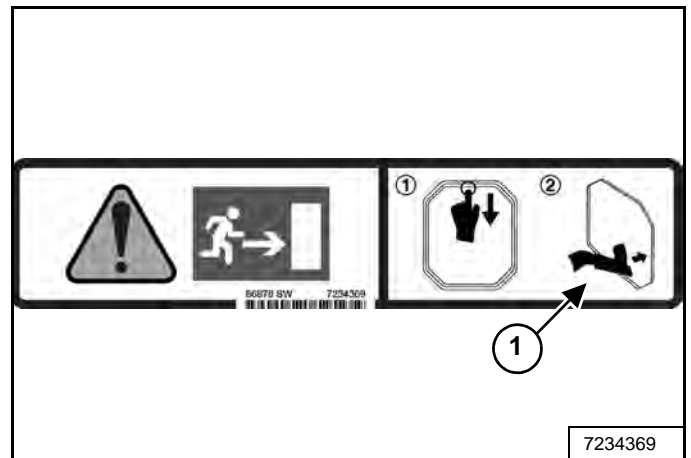

Push the window out with your foot at any corner of the window [Figure 10-230-4].

Exit through the front door.



Bobcat®

SEAT BELT

Inspection And Maintenance

! WARNING

Failure to properly inspect and maintain the seat belt can cause lack of operator restraint resulting in serious injury or death.

W-2466-0703

Check the seat belt daily for correct function.

Inspect the seat belt system thoroughly at least once each year or more often if the machine is exposed to severe environmental conditions or applications.

Any seat belt system that shows cuts, fraying, extreme or unusual wear, significant discolorations due to ultraviolet UV exposure, dusty / dirty conditions, abrasion to the seat belt webbing, or damage to the buckle, latch plate, retractor (if equipped), hardware or any other obvious problem should be replaced immediately.

The items below are referenced in **[Figure 10-240-1]**.

1. Check the webbing. If the system is equipped with a retractor, pull the webbing completely out and inspect the full length of the webbing. Look for cuts, wear, fraying, dirt and stiffness.
2. Check the buckle and latch for correct operation. Make sure latch plate is not excessively worn, deformed or buckle is not damaged or casing broken.
3. Check the retractor web storage device (if equipped) by extending webbing to determine if it looks correct and that it spools out and retracts webbing correctly.
4. Check webbing in areas exposed to ultraviolet (UV) rays from the sun or extreme dust or dirt. If the original color of the webbing in these areas is extremely faded and / or the webbing is packed with dirt, the webbing strength may have deteriorated.
5. Check the hardware on both sides of the seat. Hardware should be tight. Hardware must not be missing, rusted, corroded, or damaged.

Figure 10-240-1

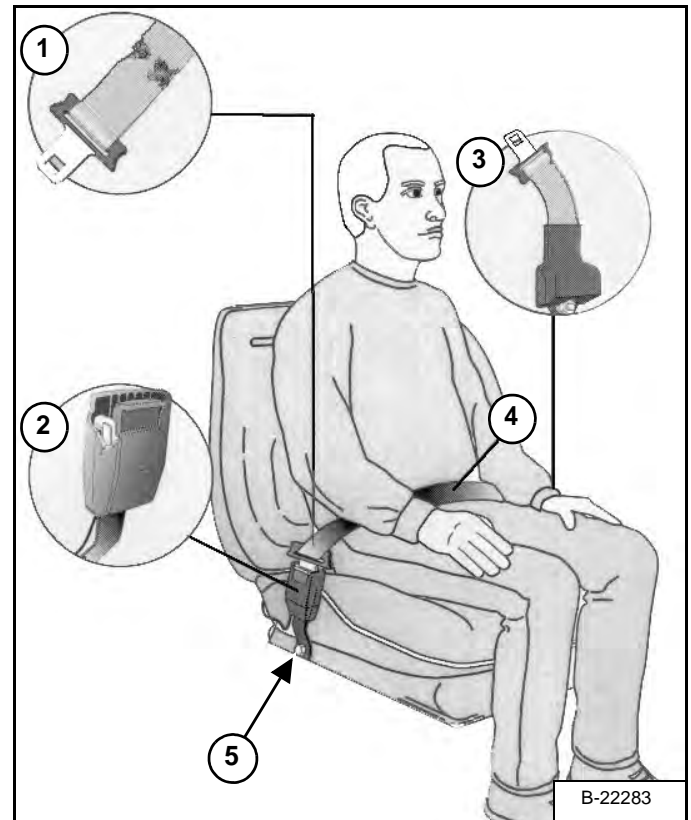



Bobcat®

HYDRAULIC SYSTEM

HYDRAULIC SYSTEM INFORMATION	20-10-1
Glossary Of Hydraulic / Hydrostatic Symbols	20-10-1
Troubleshooting Chart	20-10-5
CYLINDER (LIFT)	20-20-1
Testing	20-20-1
Removal And Installation	20-20-2
Parts Identification	20-20-4
Disassembly And Assembly	20-20-5
CYLINDER (TILT)	20-21-1
Testing	20-21-1
Removal And Installation	20-21-2
Parts Identification	20-21-3
Disassembly And Assembly	20-21-4
MAIN RELIEF VALVE	20-30-1
Description	20-30-1
Testing Without Auxiliaries	20-30-2
Testing With Auxiliaries	20-30-3
Removal And Installation	20-30-4

HYDRAULIC CONTROL VALVE	20-40-1
Description	20-40-1
BICS™ Valve Removal And Installation	20-40-2
BICS™ Valve, Lift Arm Bypass Orifice Removal And Installation	20-40-3
Pressure Differential Valve Removal And Installation	20-40-4
BICS™ Valve, Check Valve Removal And Installation	20-40-5
BICS™ Valve, Solenoid Removal And Installation	20-40-6
BICS™ Valve, Solenoid Testing	20-40-7
BICS™ Valve, Identification Chart	20-40-7
Removal And Installation	20-40-8
Identification Chart	20-40-10
Disassembly And Assembly	20-40-11
Load Check Valves Removal And Installation	20-40-11
Main Relief Valve Removal And Installation	20-40-12
Port Relief / Anti-Cavitation Valve Removal And Installation	20-40-13
Anti-Cavitation / Check Valves Removal And Installation	20-40-14
Rubber Boot Removal And Installation	20-40-15
Lift And Tilt Lock Block Removal And Installation	20-40-15
Lift Spool And Detent Removal And Installation	20-40-16
Lift Spool And Detent Disassembly	20-40-18
Lift Spool And Detent Assembly	20-40-20
Tilt Spool Removal And Installation	20-40-22
Tilt Spool Disassembly And Assembly	20-40-23
Auxiliary Spool Removal And Installation	20-40-24
Auxiliary Spool Disassembly And Assembly	20-40-25
Spool Seal Installation	20-40-28
Auxiliary Pivot Bracket Removal And Installation	20-40-29
Auxiliary Pivot Bracket Disassembly And Assembly	20-40-29
LIFT ARM BYPASS CONTROL VALVE	20-50-1
Description	20-50-1
Testing	20-50-1
Removal And Installation	20-50-2
Disassembly And Assembly	20-50-3
HYDRAULIC PUMP	20-60-1
Description	20-60-1
Direct Pump Testing	20-60-1
Removal And Installation	20-60-3
Hydraulic Pump Startup	20-60-5
Parts Identification	20-60-6
Disassembly And Assembly	20-60-7
HYDRAULIC / HYDROSTATIC FILTER	20-70-1
Description	20-70-1
Housing Removal And Installation	20-70-1
Housing Disassembly And Assembly	20-70-3

HYDRAULIC FLUID RESERVOIR	20-80-1
Description	20-80-1
Removal And Installation	20-80-2
OIL COOLER	20-90-1
Description	20-90-1
Removal And Installation	20-90-2
BUCKET POSITION VALVE	20-100-1
Description	20-100-1
Solenoid Removal And Installation	20-100-1
Solenoid Testing	20-100-2
Removal And Installation	20-100-3
Disassembly And Assembly	20-100-5
AUXILIARY HYDRAULIC INTERLOCK VALVE	20-110-1
Description	20-110-1
Removal And Installation	20-110-1
Disassembly And Assembly	20-110-2



Bobcat®

HYDRAULIC/HYDROSTATIC SCHEMATIC

**S70 (S/N A3W611001 AND ABOVE)
(S/N A3W711001 AND ABOVE)
(S/N B38V11001 AND ABOVE)
(S/N B38W11001 AND ABOVE)
(S/N B4TY11001 AND ABOVE)
(S/N B4UC11001 AND ABOVE)**

(PRINTED OCTOBER 2019)

[Printable Version Click Here](#)

V-1011 legend

LEGEND

- | | |
|--|--|
| ① VARIABLE DISPLACEMENT
BIDIRECTIONAL HYDROSTATIC PUMP | ⑩ OIL COOLER |
| ② RELIEF / REPLENISHING VALVE – HIGH
PRESSURE: 20684 kPa (207 bar) (3000 psi) | ⑪ ANTICAVITATION VALVE |
| ③ RELIEF VALVE – CHARGE INLET:
S/N A3W611001 – A3W613788 , A3W711001 –
A3W713562: 586 kPa (5,9 bar) (85 psi)

S/N A3W613789 & Above, S/N A3W713563 & Above,
S/N B38V11001 & Above, S/N B38W11001 & Above,
S/N B4TY11001 & Above, S/N B4UC11001 & Above:
862 kPa (8,6 bar) (125 psi) | ⑫ LOAD CHECK VALVE |
| ④ BIDIRECTIONAL HYDROSTATIC DRIVE MOTOR | ⑬ RELIEF / ANTICAVITATION VALVE –
PORT: 24132 kPa (241 bar) (3500 psi) |
| ⑤ HYDRAULIC PUMP.....Gear Type:
8.9 GPM (33,7 L/min) @ High Engine RPM | ⑭ RELIEF VALVE – MAIN – DUAL STAGE:
Main Hydraulic - 13790 kPa (138 bar) (2000 psi)
Auxiliary Hyd - 20684 kPa (207 bar) (3000 psi) |
| ⑥ RESERVOIR:
Capacity at sight gauge 5 L (5.3 qt)
System Capacity 15,1 L (4.0 U,S, gal) | ⑮ SOLENOID ACTIVATED DIRECTIONAL
CONTROL VALVE: Bucket Positioning
On / Off |
| ⑦ FILTER – HYDRAULIC: 11 micron | ⑯ FLOW DIVIDER ADJUSTMENT VALVE |
| ⑧ FILTER BYPASS VALVE: 280-340 kPa (2,8-3,4 bar)
(41-51 psi) | ⑰ PILOT ACTIVATED DIRECTIONAL CONTROL
VALVE: FLOW CONTROL SPOOL |
| ⑨ DIFFERENTIAL PRESSURE SWITCH:
117 – 145 kPa (1,2 – 1,4 bar) (17 - 21 psi) | ⑱ CHECK VALVE – BUCKET POSITION VALVE |
| | ⑲ PILOT ACTIVATED DIRECTIONAL
CONTROL VALVE: UNLOADING SPOOL |
| | ⑳ PILOT ACTIVATED DIRECTIONAL
CONTROL VALVE: BICS Cartridge |
| | ㉑ PILOT ACTIVATED DIRECTIONAL
CONTROL VALVE: BICS Cartridge |
| | ㉒ SOLENOID AVTIVATED DIRECTIONAL
CONTROL VALVE – BICS Control |
| | ㉓ INLET SCREEN / FILTER |
| | ㉔ CHECK VALVE: Inside of Inlet Fitting |
| | ㉕ INLET SCREEN / FILTER |
| | ㉖ MANUALLY AVTIVATED DIRECTIONAL
CONTROL VALVE – Lift Arm Bypass |
| | ㉗ TILT CYLINDER |
| | ㉘ LIFT CYLINDER |
| | ㉙ SOLENOID AVTIVATED DIRECTIONAL
CONTROL VALVE – Auxiliary Hydraulic
Pressure Release |
| | ㉚ QUICKCOUPLER MALE |
| | ㉛ QUICKCOUPLER FEMALE |

NOTE: Unless otherwise specified, springs have
NO significant pressure value.

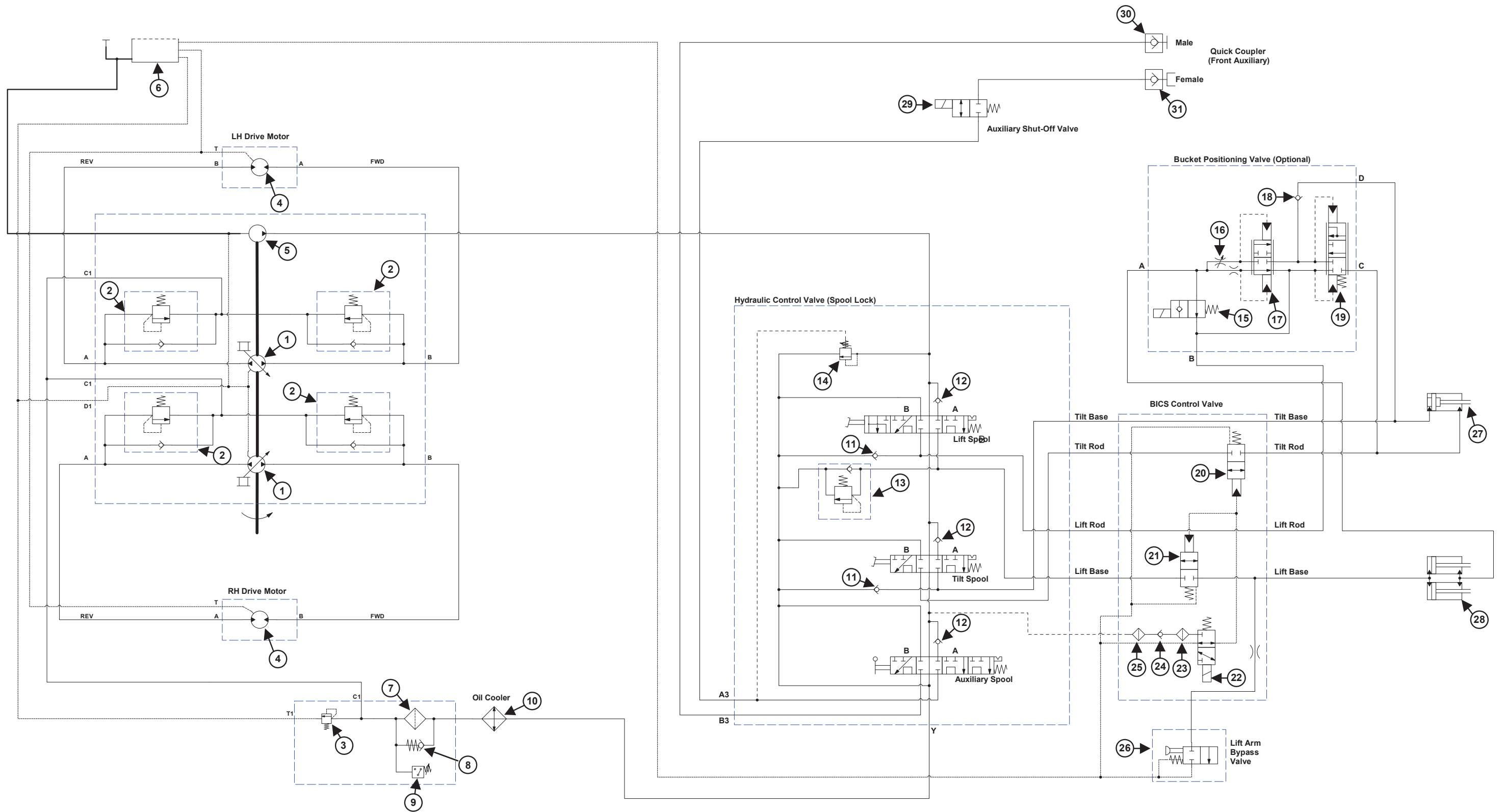

- - - - - ENCLOSURE
 ——— PUMP SUPPLY
 ——— WORKING CIRCUITS
 - - - - - PILOT PRESSURE
 - - - - - DIRECT TANK RETURN
 - - - - - SYSTEM RETURN LINES











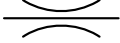

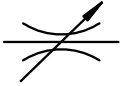

**HYDRAULIC/HYDROSTATIC SCHEMATIC
 S70 (S/N A3W611001 AND ABOVE)
 (S/N A3W711001 AND ABOVE)
 (S/N B38V11001 AND ABOVE)
 (S/N B38W11001 AND ABOVE)
 (S/N B4TY11001 AND ABOVE)
 (S/N B4UC11001 AND ABOVE)**

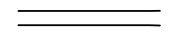
[Printable Version Click Here](#)

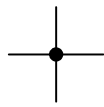
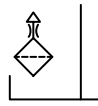
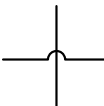
(PRINTED OCTOBER 2019)
 7134082 (D)

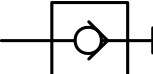

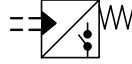







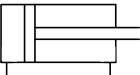

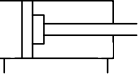
HYDRAULIC SYSTEM INFORMATION

Glossary Of Hydraulic / Hydrostatic Symbols

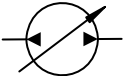
SYMBOL	DESCRIPTION	SYMBOL	DESCRIPTION
FLOW LINES and CONNECTIONS		BASIC and MISCELLANEOUS SYMBOLS	
	WORKING CIRCUITS - Continuous, Solid Line - Working (Main) Line, Return Line (line conducting fluid from working devices to the reservoir) and Feed line (main line conductor).		RESTRICTION - Line with Fixed Restriction - Affected by Viscosity (property of resistance to flowing fluid).
	PILOT PRESSURE - Dashed Line - Pilot Line (Conducts control fluid).		VARIABLE ADJUSTMENT RESTRICTION - Regulated or Variable Restriction.
	DRAIN CIRCUITS - Dotted Line - Drain Line (drain or bleed line - conducting fluid from a component housing to the reservoir).		TEMPERATURE CONTROL - (Indication of temperature).
	COMPONENTS - Long Chain Line - Enclosure outline for several components assembled in one unit.		TEMPERATURE INDICATOR - (temperature measurement - thermometer).
	MECHANICAL CONNECTIONS - Double Line (Shaft, Lever, Piston Rod).		FILTER (strainer or screen) - For fluid conditioning.
	CONNECTED JUNCTION OF OIL LINES (Flow Line Connection).		VENTED AND FILTERED RESERVOIR (reservoir open to atmosphere).
	OIL LINES CROSSING (NOT Connected).		PRESSURIZED, VENTED AND FILTERED RESERVOIR (Reservoir uses a pressured cap).
	COUPLER - Quick - Acting Coupling (uncoupled, closed by non-return valve).		OIL COOLER (heat exchanger) - The arrows in the diamond indicate the extraction of heat (heat dissipation).
			PRESSURE SENSOR - Varies electric signal with pressure.
			DIFFERENTIAL PRESSURE SWITCH - Switch activates when pressure difference reaches specified level.
			PRESSURE SWITCH - Switch activates when pressure reaches specified level.
			MUFFLER (silencer) - Reduces noise.

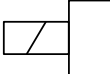

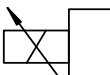
HYDRAULIC SYSTEM INFORMATION (CONT'D)

Glossary Of Hydraulic / Hydrostatic Symbols (Cont'd)

SYMBOL	DESCRIPTION	SYMBOL	DESCRIPTION
			CONTROL MECHANISMS
	<p>CYLINDER: Equipment to convert hydraulic energy into linear energy and in which the fluid pressure operates alternately in both directions (forward and backward strokes).</p>		CONTROL VALVE WITH DETENT (Holds Valve in Position) - device for maintaining a given position (mechanical).
	DOUBLE ACTING HYDRAULIC CYLINDER, UNEQUAL DISPLACEMENT - With single piston rod.		CONTROL VALVE ACTIVATED BY A PULL BUTTON (manual).
	DOUBLE ACTING HYDRAULIC CYLINDER, UNEQUAL DISPLACEMENT and CUSHION ON ONE END - With single piston rod.		CONTROL VALVE ACTIVATED BY A PUSH-PULL BUTTON (manual).
	<p>PUMP: To convert mechanical energy into hydraulic energy.</p>		CONTROL VALVE ACTIVATED BY A LEVER (manual).
	FIXED CAPACITY DISPLACEMENT HYDRAULIC PUMP - With one direction of flow.		CONTROL VALVE ACTIVATED BY A PEDAL (manual).
	VARIABLE CAPACITY DISPLACEMENT BIDIRECTIONAL HYDRAULIC PUMP - With two directions of flow (bidirectional).		CONTROL VALVE WITH SPRING RETURN (mechanical).
	<p>MOTOR: To convert hydraulic energy into rotary mechanical energy.</p>		CONTROL VALVE ACTIVATED BY AN ELECTRIC SOLENOID (electrical).
	FIXED CAPACITY DISPLACEMENT BIDIRECTIONAL HYDRAULIC MOTOR - With two directions of flow (bidirectional).		CONTROL VALVE ACTIVATED BY A PROPORTIONAL ELECTRICAL SOLENOID (electrical).
			CONTROL VALVE ACTIVATED BY DUAL ELECTRICAL SOLENOID (electrical).
			CONTROL VALVE ACTIVATED BY PILOT PRESSURE (indirect control, pilot actuated by application of pressure).

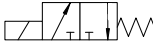
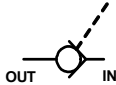
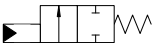
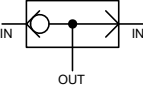
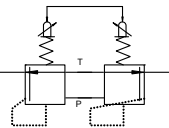
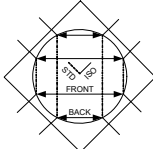
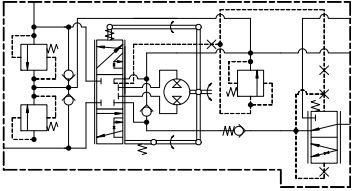
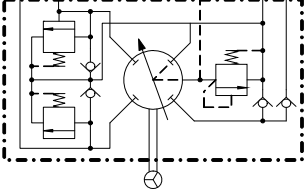
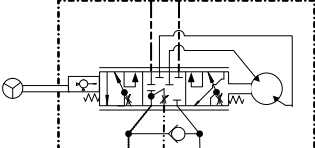

HYDRAULIC SYSTEM INFORMATION (CONT'D)

Glossary Of Hydraulic / Hydrostatic Symbols (Cont'd)

SYMBOL	DESCRIPTION	SYMBOL	DESCRIPTION
	<p>NON-RETURN VALVE (Check Valve) - Used as Replenishing Valve, Lock Check Valve or Anticavitation Valve - Opens if the Inlet pressure is higher than the Outlet pressure. Often contains internal spring which has NO significant pressure value.</p>		<p>TWO PORTS and CLOSED FLOW PATHS</p>
	<p>SPRING LOADED VALVE (bypass Valve) - Opens if the Inlet pressure is greater than the Outlet pressure plus the spring pressure.</p>		<p>SOLENOID ACTIVATED DIRECTIONAL CONTROL VALVE (Two Position) - controlled by an electric solenoid (with return spring).</p>
	<p>PILOT CONTROLLED NON-RETURN VALVE- It is possible to open the valve by pilot pressure.</p>		<p>PILOT ACTIVATED DIRECTIONAL CONTROL VALVE (Two Position) - controlled by pressure (with return spring).</p>
	<p>SHUTTLE VALVE - The Inlet port connected to the higher pressure is automatically connected to the Outlet port while the other Inlet port is closed.</p>		<p>MANUALLY ACTIVATED DIRECTION CONTROL VALVE (Variable Position) Joystick Controlled, variable pressure to shift the pilot activated directional control valve spool.</p>
			<p>MANUALLY ACTIVATED FLOW CONTROL VALVE (Two Position) allows for changing pilot flow to control switching joystick functions for STD / ISO Control (Excavators Only).</p>
			<p>STEERING CONTROL VALVE (Variable Position) - Used for controlling the hydraulic flow for the steering cylinders in relationship to the amount the steering wheel is rotated.</p>
			
			

HYDRAULIC SYSTEM INFORMATION (CONT'D)

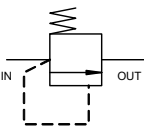
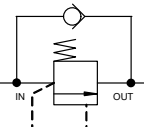
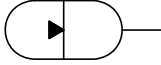
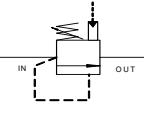
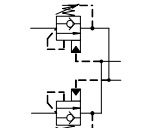
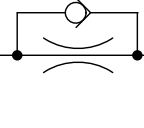
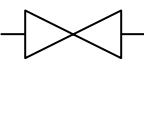
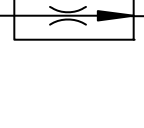
Glossary Of Hydraulic / Hydrostatic Symbols (Cont'd)

SYMBOL	DESCRIPTION	SYMBOL	DESCRIPTION
			MISCELLANEOUS
	<p>PRESSURE CONTROL VALVE: Valve ensuring the control of pressure.</p> 		
	<p>RELIEF VALVE - When the Inlet pressure overcomes the opposing force of the spring, the valve opens permitting flow from the Outlet port.</p> 		<p>ACCUMULATOR - Supplies temporary reserve pressure to the hydraulic system when the engine has been stopped.</p>
	<p>RELIEF / REPLENISHING VALVE or RELIEF / ANTICAVITATION VALVE - When the Inlet pressure overcomes the opposing force of the spring, the valve opens permitting flow from the Outlet port - Allows free flow in the opposite direction.</p> 		
	<p>DUAL PRESSURE RELIEF VALVE - When the Inlet pressure overcomes the opposing force of the spring, the valve opens permitting flow from the Outlet port. Pilot pressure provides a second pressure value.</p> 		
	<p>LOCK VALVE - hydraulic pressure is applied to open the valve to allow the hydraulic cylinder to move.</p> 		
	<p>FLOW CONTROL VALVE: Valve controlling the flow in one or both directions.</p>		
	<p>ONE WAY RESTRICTOR VALVE (Non-Return Valve with Restriction) - Unit allowing free flow in one direction but restricted flow in the other direction.</p> 		
	<p>TOW VALVE - Normally in closed position.</p> 		
	<p>LOAD SENSE BLEED VALVE - Regulates small amount of fluid flow (leakage).</p> 		

HYDRAULIC SYSTEM INFORMATION (CONT'D)

Troubleshooting Chart

The following troubleshooting chart is provided for assistance in locating and correcting problems which are most common. Many of the recommended procedures must be done by authorized Bobcat Service Personnel only.



WARNING

Check for correct function after adjustments, repairs or service. Failure to make correct repairs or adjustments can cause injury or death.

W-2004-1285

PROBLEM	CAUSE
The hydraulic system will not operate.	1, 2, 3, 5, 8
The transmission warning light comes ON when hydraulics are operating.	1, 3
Slow hydraulic system action.	1, 3, 4, 6, 8
Hydraulic action is not smooth.	1, 4, 5, 6, 7
Lift arms go up slowly at full engine rpm.	1, 3, 4, 6, 7, 8, 9
The lift arms or Bob-Tach will move when the pedal is in neutral position.	4
The lift arms come down with the pedal in the neutral position	4, 9, 10, 11
Slow Hydraulic System Action	1, 3, 4, 6, 8, 12

KEY TO CORRECT THE CAUSE
1. The fluid level is not correct.
2. The pedal linkage is disconnected.
3. The hydraulic pump has damage.
4. The pedal linkage is not adjusted correctly.
5. Relief valve is not at the correct pressure.
6. Suction leak on the inlet side of the hydraulic pump.
7. Fluid is cold. Wrong viscosity fluid. (See (S70) LOADER SPECIFICATIONS on Page SPEC-10-1.)
8. Exceeding the loaders rated operating capacity.
9. Internal leak in the lift cylinder(s).
10. External leak from the lift cylinder(s).
11. Damaged lift spool.
12. Debris in the Main Relief Valve.



Bobcat®

CYLINDER (LIFT)

Testing

Open the rear door.

Figure 20-20-1

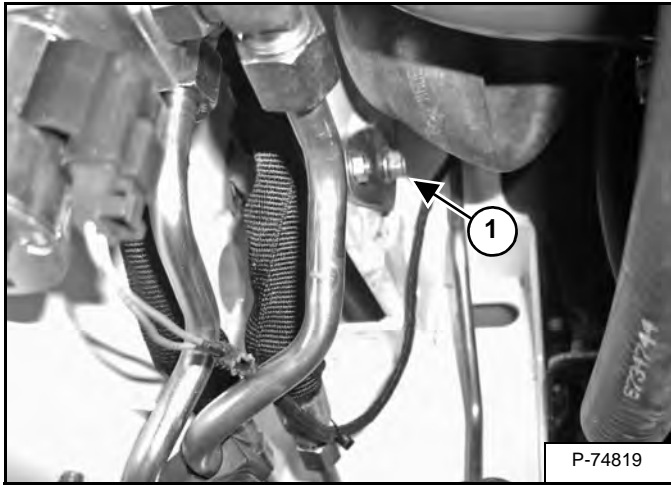

Remove the bolt (Item 1) [Figure 20-20-1] from the base end pin retainer (left side shown).

Figure 20-20-2



Use a slide hammer to remove the pivot pin (left side shown) [Figure 20-20-2].

Pull the cylinder forward. Mark the hoses for correct reassembly.

Check only one cylinder at a time.

WARNING

Hydraulic fluid escaping under pressure can have sufficient force to enter a person's body by penetrating the skin. This can cause serious injury and possible death if proper medical treatment by a physician familiar with this injury is not received immediately.

W-2145-0290

Figure 20-20-3

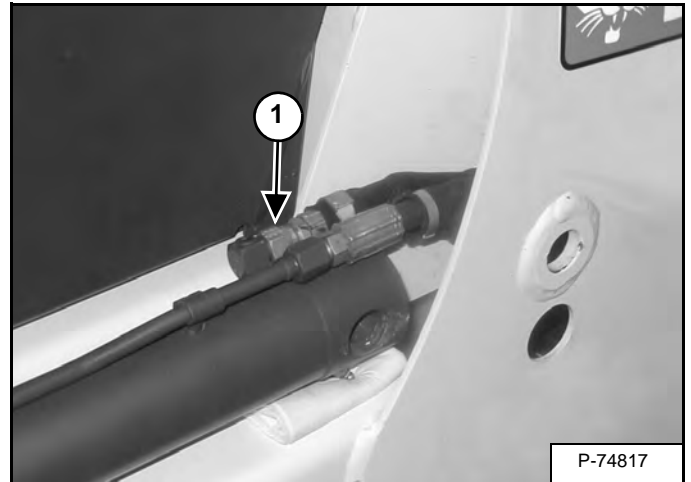

Disconnect the hose (Item 1) [Figure 20-20-3] from the lift cylinder base end port.

Install a plug in the hose and tighten the plug.

Lower the seat bar, engage the parking brake and start the engine. Loaders without seat sensors press the green PRESS TO OPERATE button.

Push the top (toe) of the lift pedal until system relief pressure is reached.

If there is leakage from the open base end port of the lift cylinder, remove the lift cylinder for repair. (See Removal And Installation on Page 20-20-2.)

WARNING

AVOID INJURY OR DEATH

Always clean up spilled fuel or oil. Keep heat, flames, sparks or lighted tobacco away from fuel and oil. Failure to use care around combustibles can cause explosion or fire.

W-2103-0508

CYLINDER (LIFT) (CONT'D)

Removal And Installation

Fully lower the lift arms.

Stop the engine. Pull up on the lift arm bypass control and move the lift pedal to release the hydraulic pressure. Raise the seat bar. Engage the parking brake. Raise the operator cab. (See Raising on Page 10-30-2.)

Figure 20-20-4

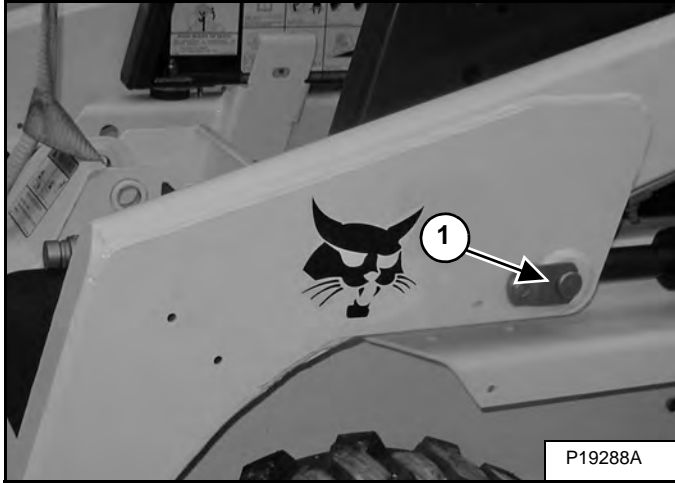

Install a lifting strap around the center of the lift arms crossmember, fasten the strap to a chain hoist and the lift arms slightly as shown [Figure 20-20-4].

Remove the rod end retainer bolt (Item 1) [Figure 20-20-4] from the left cylinder.

Installation: Tighten the bolt to 24 - 27 N•m (18 - 20 ft-lb) torque.

Remove the retainer and the rod end pin [Figure 20-20-4].

Figure 20-20-5

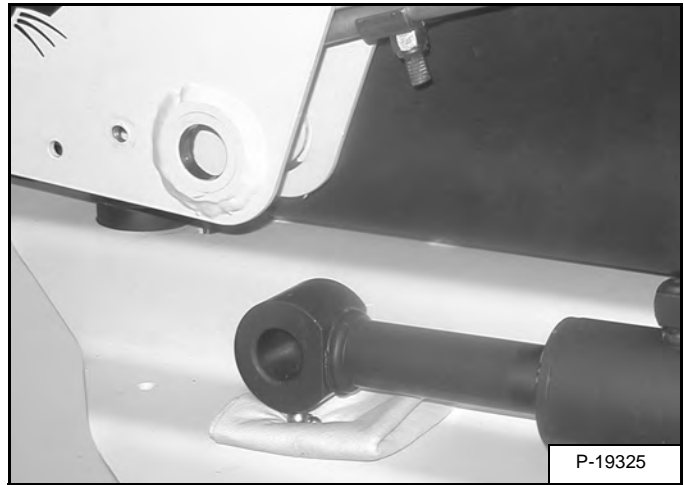

Lower the left cylinder onto the fender [Figure 20-20-5].

Figure 20-20-6

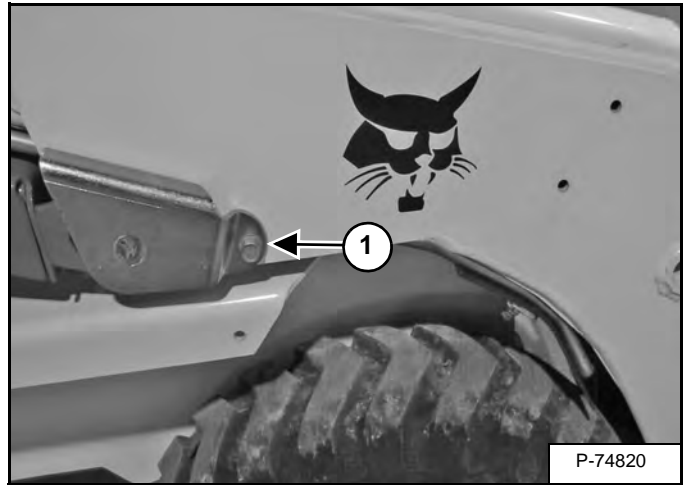

Remove the bolt (Item 1) [Figure 20-20-6] to remove the cover and pivot pin from the right lift cylinder.

Installation: Tighten the bolt to 24 - 27 N•m (18 - 20 ft-lb) torque.

Remove the cover and pivot pin [Figure 20-20-6].

CYLINDER (LIFT) (CONT'D)

Removal And Installation (Cont'd)

Figure 20-20-7

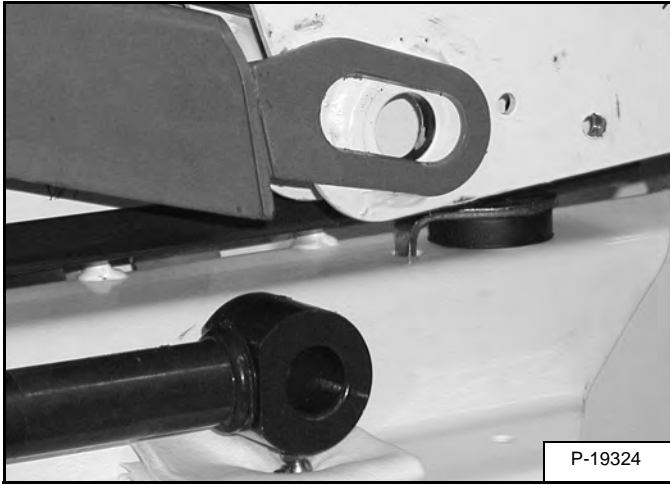

Lower the right lift cylinder onto the fender [Figure 20-20-7].

Figure 20-20-8

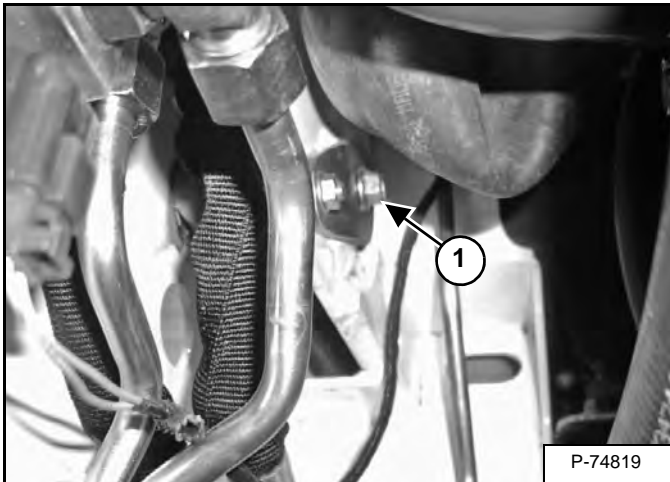

Open the rear door.

Remove the bolt (Item 1) [Figure 20-20-8] from the base end pin retainer (left side shown).

Installation: Tighten the bolt to 24 - 27 N•m (18 - 20 ft-lb) torque.

Figure 20-20-9



Use a slide hammer to remove the pivot pin (left side shown) [Figure 20-20-9].

Figure 20-20-10

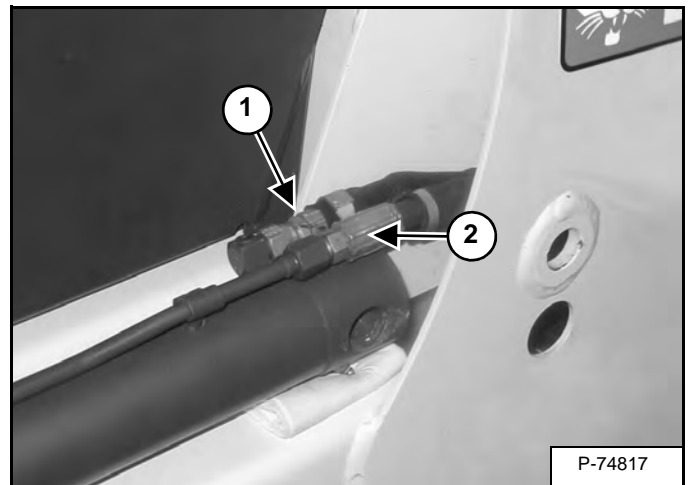

Pull the cylinder forward to remove the hose (Item 1) from the base end and the hose (Item 2) [Figure 20-20-10] from the rod end. Mark the hoses for correct reassembly.

Install the cylinder(s) in the reverse order.

CYLINDER (LIFT) (CONT'D)

Parts Identification

- 1. Tubeline
- 2. Plug
- 3. O-ring*
- 4. Clamp
- 5. Case
- 6. Nut
- 7. Piston
- 8. Seal
- 9. Spacer
- 10. Back-up Ring*
- 11. Rod Seal
- 12. Head
- 13. Wiper
- 14. Rod

* 3 and 10 were replaced by a one-piece seal.
See parts manual for replacement parts.

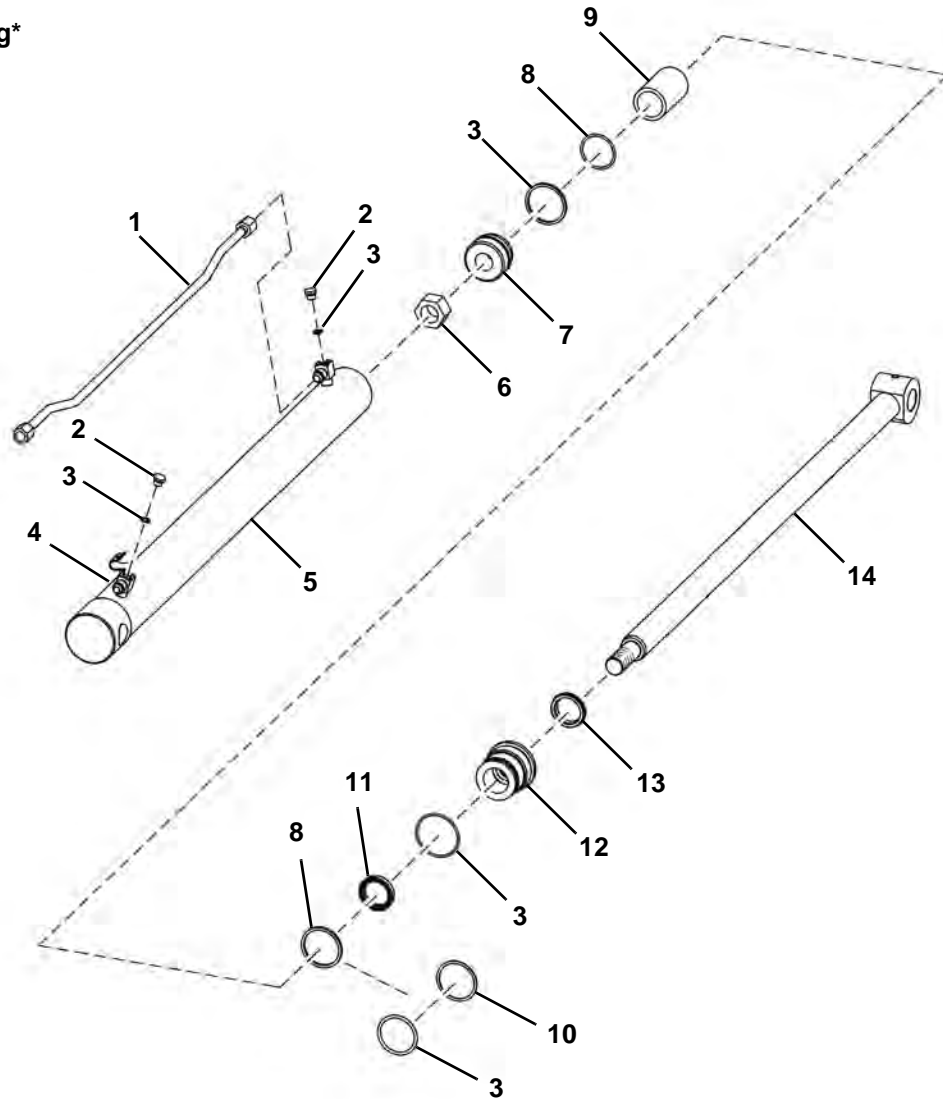

PE-1646S

CYLINDER (LIFT) (CONT'D)

Disassembly And Assembly

Use the following tools to disassemble and assemble the cylinder:

MEL1074 - O-ring Seal Hook
MEL1396 - Seal Installation Tool
MEL1033 - Rod Seal Installation Tool
Piston Ring Compressor
Spanner Wrench

Hold the hydraulic cylinder over a drain pan and move the rod in and out slowly to remove the fluid from the cylinder.

Put the base end of the cylinder in a vise.

Figure 20-20-11

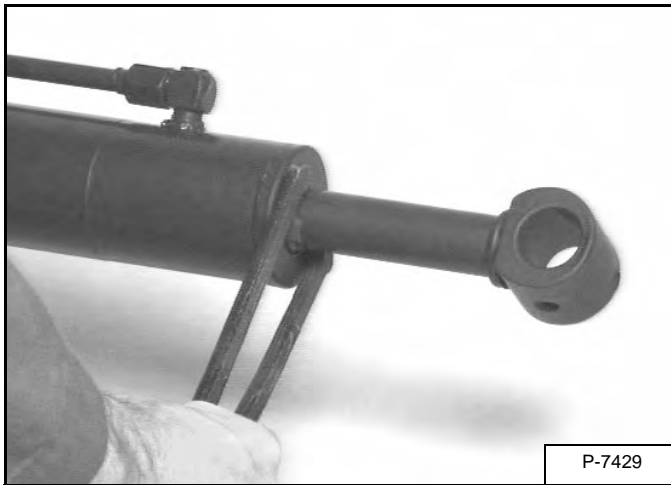

Use a spanner wrench to loosen the head [Figure 20-20-11].

Assembly: Tighten the head [Figure 20-20-11] to 217 N•m (160 ft-lb) torque.

Figure 20-20-12

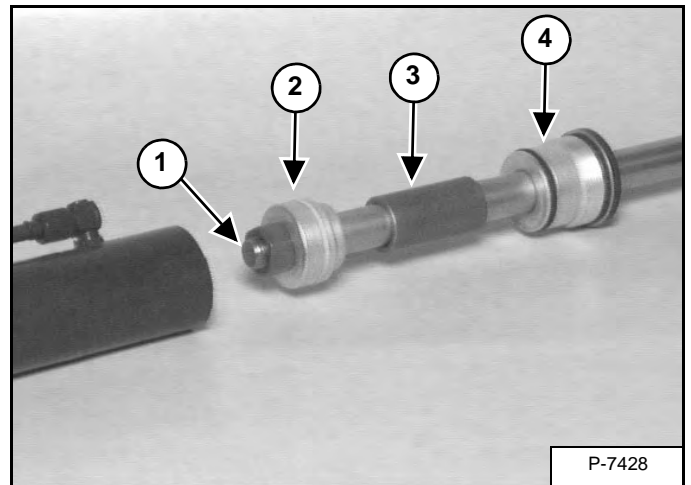

Remove the head and the rod assembly from the cylinder [Figure 20-20-12].

Put the rod end in a vise.

Remove the nut (Item 1), piston (Item 2), spacer (Item 3) and head (Item 4) [Figure 20-20-12].

Assembly: Tighten the nut (Item 1) [Figure 20-20-12] to 407 N•m (300 ft-lb) torque.

Figure 20-20-13

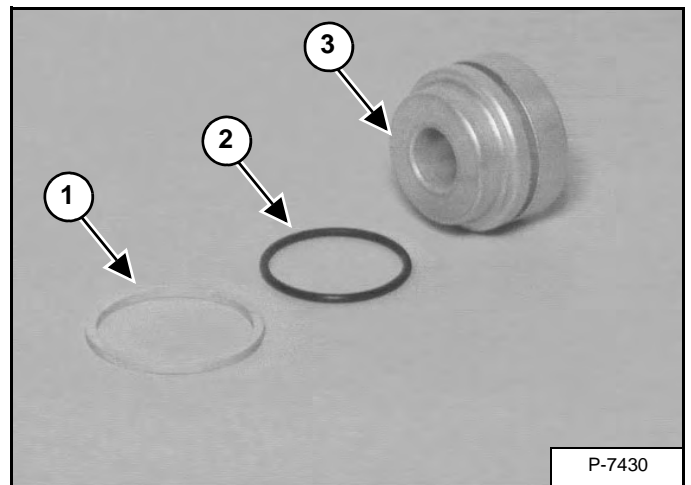

Remove the seal (Item 1) and O-ring (Item 2) from the piston (Item 3) [Figure 20-20-13].

CYLINDER (LIFT) (CONT'D)

Disassembly And Assembly (Cont'd)

Figure 20-20-14

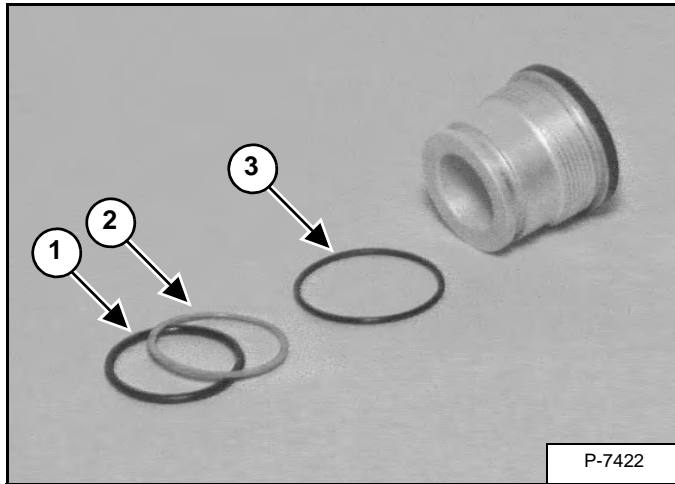

Remove the O-ring (Item 1) and the back-up ring (Item 2) from the groove in the head. Remove the O-ring (Item 3) [Figure 20-20-14].

NOTE: O-ring (Item 1) and back-up ring (Item 2) [Figure 20-20-14] were replaced by a one-piece seal. Use the version currently supplied through parts.

Figure 20-20-15

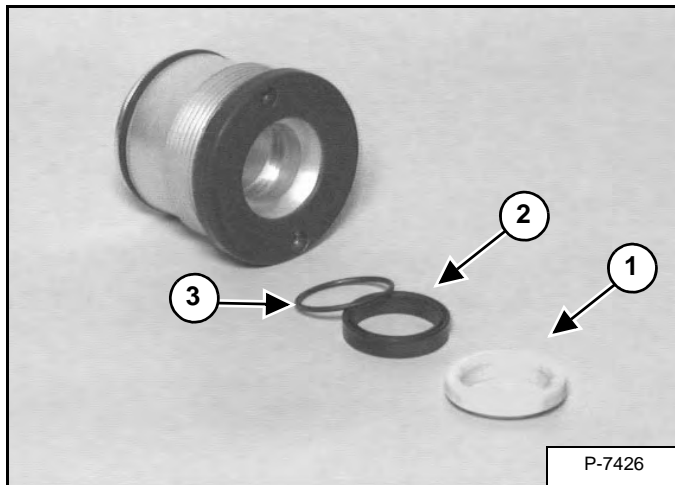

Remove the wiper seal (Item 1), and rod seal (Item 2) [Figure 20-20-15].

Remove the O-ring (Item 3) [Figure 20-20-15] from the rod seal.

Wash the cylinder parts in solvent and air dry them.

Inspect the cylinder for nicks, scratches or other damage. Replace any damaged parts.

Always install new O-rings and seals during assembly.

Lubricate all O-rings and seals with hydraulic oil during installation.

Figure 20-20-16

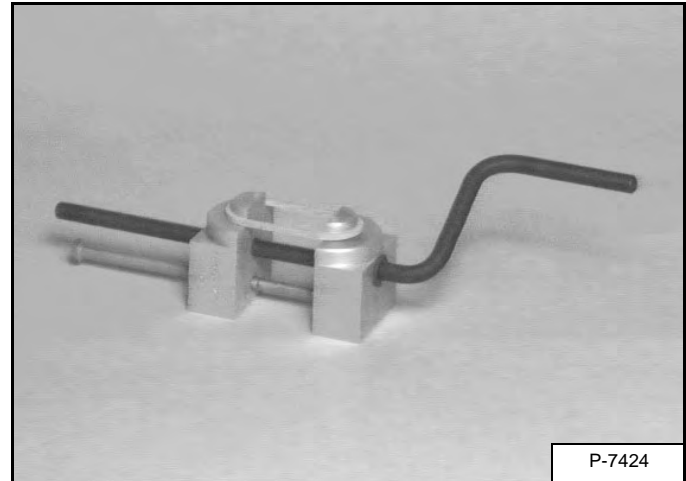

Install a new seal on the tool and slowly stretch it until it fits the piston [Figure 20-20-16].

Allow the seal the stretch for 30 seconds before installing it on the piston.

Use a ring compressor to compress the seal to the correct size. Leave the piston in the compressor for about three minutes.

CYLINDER (LIFT) (CONT'D)

Disassembly And Assembly (Cont'd)

Figure 20-20-17

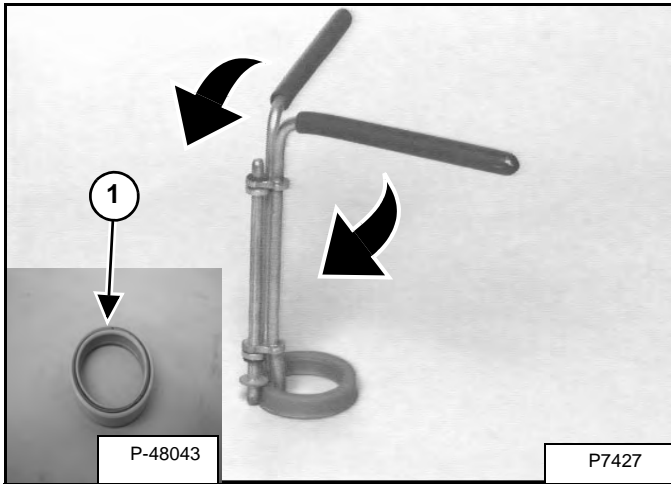

Install the rod seal (Item 1) on the rod seal tool [Figure 20-20-17].

NOTE: During installation of the spring side of the seal (Item 1) [Figure 20-20-17] must be toward the inside of the cylinder.

Rotate the handles to collapse the rod seal.

Figure 20-20-18

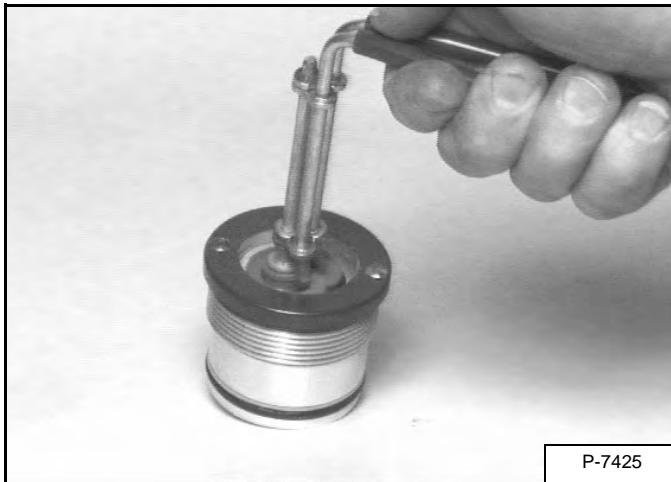

Install the rod seal in the head [Figure 20-20-18].

Install the wiper seal with the wiper toward the outside of the head.

Assemble the cylinder(s) in the reverse order.



Bobcat®

CYLINDER (TILT)

Testing

Remove the attachment. Tilt the Bob-Tach fully forward until it rests on the floor. Stop the engine. Raise the seat bar.

WARNING

Hydraulic fluid escaping under pressure can have sufficient force to enter a person's body by penetrating the skin. This can cause serious injury and possible death if proper medical treatment by a physician familiar with this injury is not received immediately.

W-2145-0290

Figure 20-21-1

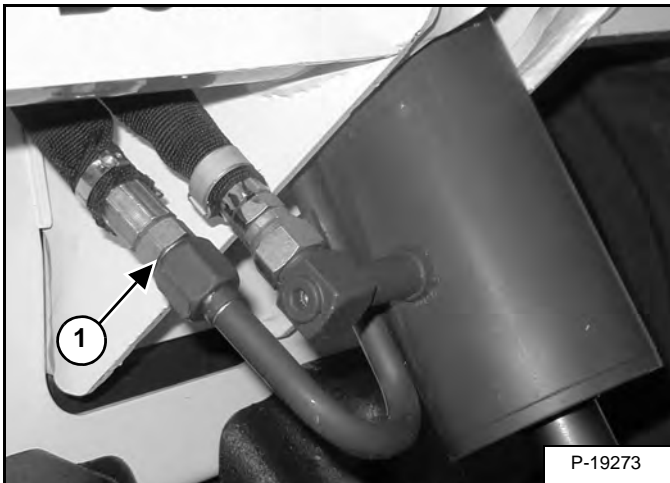

Disconnect the hose (Item 1) [Figure 20-21-1] from the base end of the tilt cylinder.

Install a plug in the hose and tighten the plug.

Lower the seat bar, engage the parking brake and start the engine.

Push the bottom (heel) of the tilt pedal until system relief pressure is reached.

There should be no leaks from the base end of the port.

If there is leakage from the open port of the tilt cylinder, remove the cylinder for repairs.

CYLINDER (TILT) (CONT'D)

Removal And Installation

Remove the attachment. Tilt the Bob-Tach fully forward until it rests on the floor. Stop the engine. Raise the seat bar.

Engage the parking brake.

Figure 20-21-2

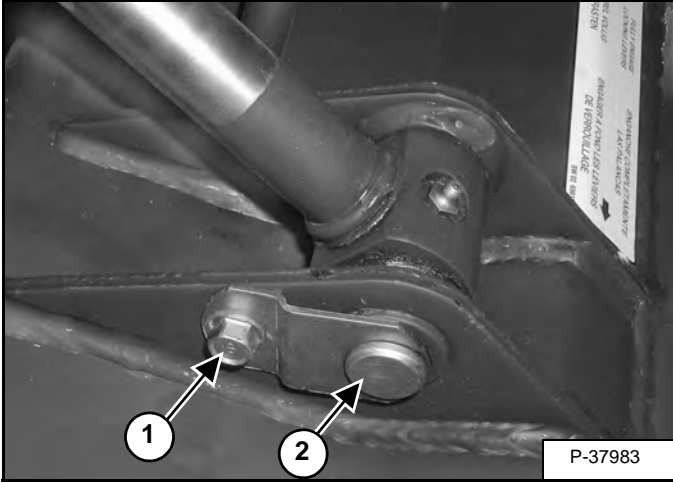

Remove the bolt (Item 1) and the retainer (Item 2) [Figure 20-21-2] from the Bob-Tach and tilt cylinder rod end pivot pin.

Installation: Tighten the bolt to 24 - 27 N•m (18 - 20 ft-lb) torque.

Remove the pivot pin from the Bob-Tach.

Figure 20-21-3

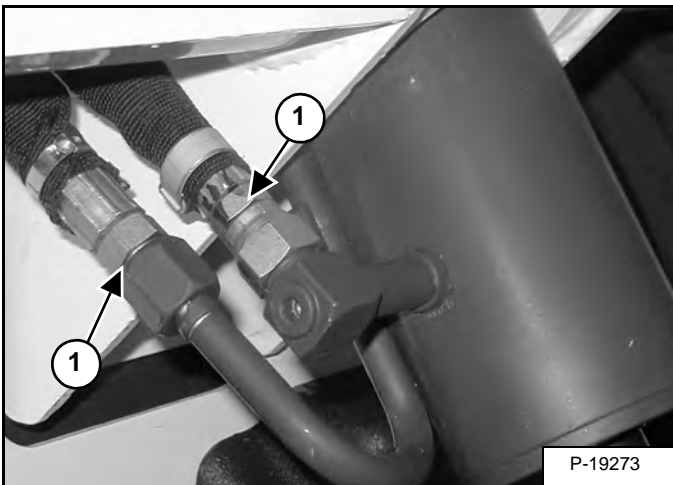

Remove the hoses (Item 1) [Figure 20-21-3] from the tilt cylinder fittings.

Figure 20-21-4

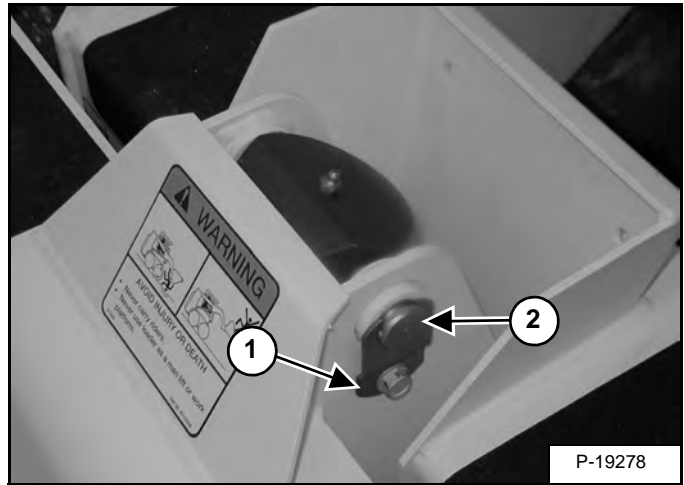

Remove the bolt (Item 1) and the retainer (Item 2) [Figure 20-21-4] from the base end of the tilt cylinder.

Figure 20-21-5

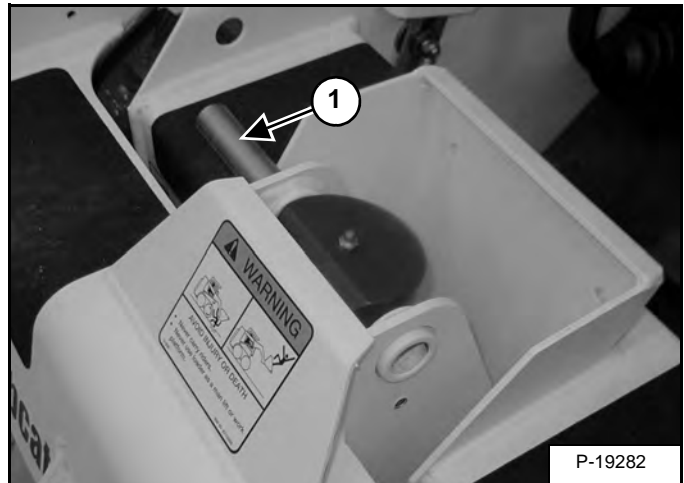

Remove the pivot pin (Item 1) [Figure 20-21-5] from the tilt cylinder base end and the lift arm frame.

CYLINDER (TILT) (CONT'D)

Parts Identification

- 1. Case
- 2. O-ring *
- 3. Plug
- 4. Tubeline
- 5. Clamp
- 6. Nut
- 7. Piston
- 8. Back-up Ring*
- 9. Seal*
- 10. Head
- 11. Rod Seal
- 12. Wiper
- 13. Rod
- 14. Bushing
- 15. Oil Seal

* 2 and 8 were replaced by a one-piece seal.
See parts manual for replacement parts.

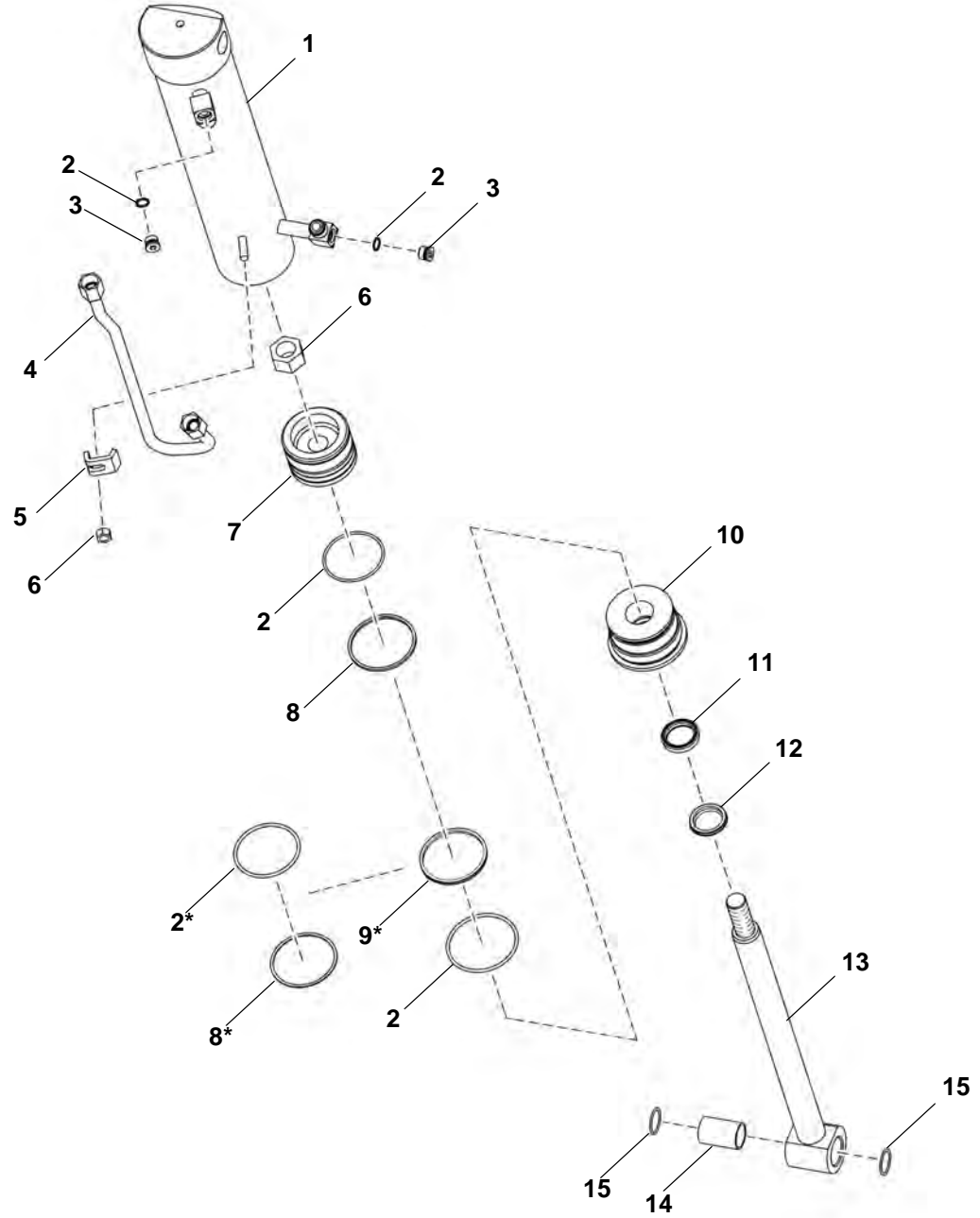

PE1349S

CYLINDER (TILT) (CONT'D)

Disassembly And Assembly

Use the following tools to disassemble and assemble the cylinder:

MEL1074 - O-ring Seal Hook
MEL1396 - Seal Installation Tool
MEL1033 - Rod Seal Installation Tool
Piston Ring Compressor
Spanner Wrench

Hold the hydraulic cylinder over a drain pan and move the rod in and out slowly to remove the fluid from the cylinder.

Put the base end of the cylinder in a vise.

Figure 20-21-6

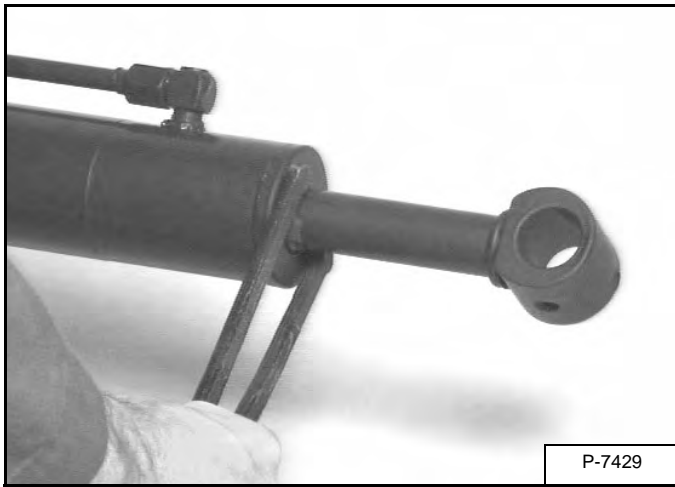

Use a spanner wrench to loosen the head [Figure 20-21-6].

Assembly: Tighten the head [Figure 20-21-6] to 373 N•m (275 ft-lb) torque.

Figure 20-21-7

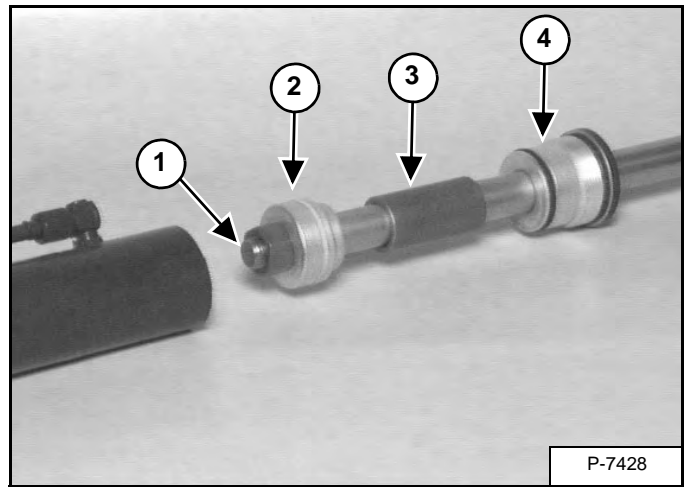

Remove the head and the rod assembly from the cylinder (Item 1) [Figure 20-21-7].

Put the rod end in a vise.

Remove the nut (Item 1), piston (Item 2), spacer (Item 3) and head (Item 4) [Figure 20-21-7].

Assembly: Tighten the nut (Item 1) [Figure 20-21-7] to 339 N•m (250 ft-lb) torque.

Figure 20-21-8

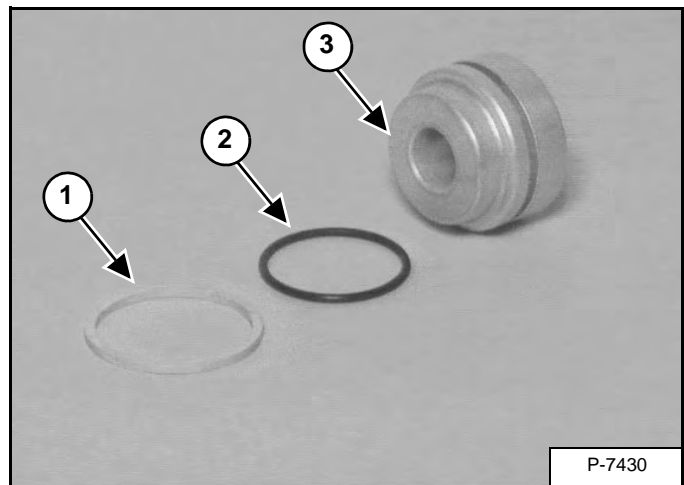

Remove the seal (Item 1) and O-ring (Item 2) from the piston (Item 3) [Figure 20-21-8].

CYLINDER (TILT) (CONT'D)

Disassembly And Assembly (Cont'd)

Figure 20-21-9

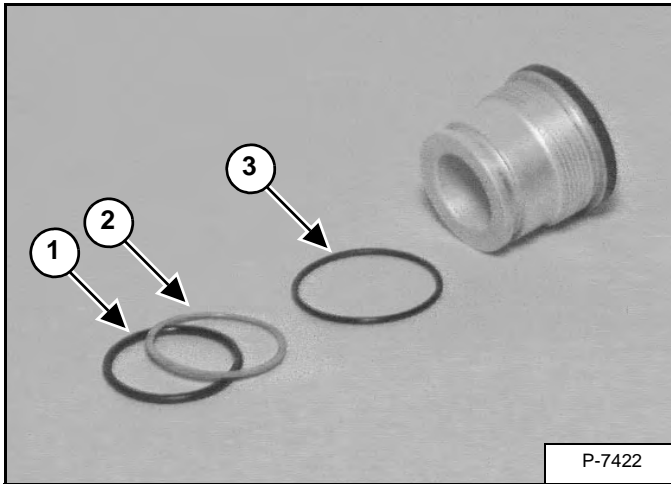

Remove the O-ring (Item 1) and the back-up ring (Item 2) from the groove in the head. Remove the O-ring (Item 3) [Figure 20-21-9].

NOTE: O-ring (Item 1) and back-up ring (Item 2) [Figure 20-21-9] were replaced by a one-piece seal. Use the version currently supplied through parts.

Figure 20-21-10

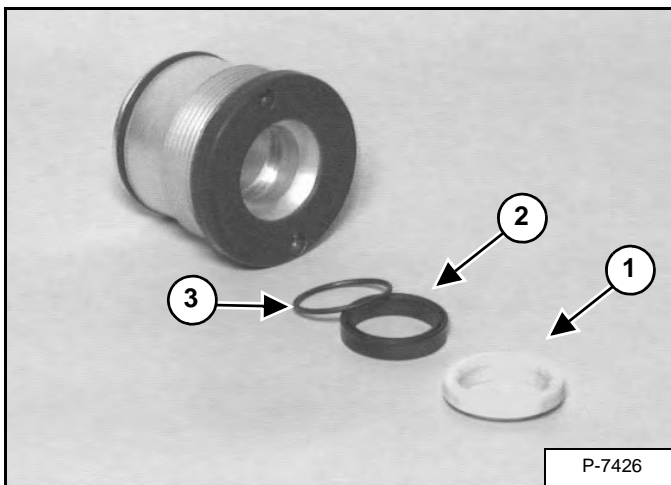

Remove the wiper seal (Item 1), and the rod seal (Item 2) [Figure 20-21-10].

Remove the O-ring (Item 3) [Figure 20-21-10] from the rod seal.

Wash the cylinder parts in solvent and air dry them.

Inspect the cylinder for nicks, scratches or other damage. Replace any damaged parts.

Always install new O-rings and seals during assembly.

Lubricate all O-rings and seals with hydraulic oil during installation.

Figure 20-21-11

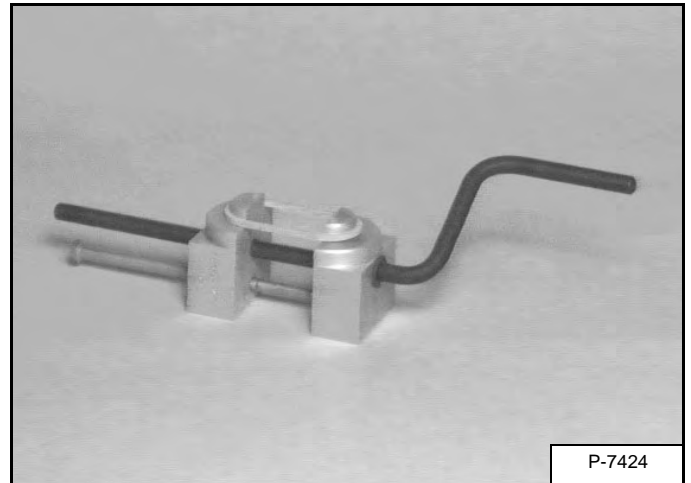

Install a new seal on the tool and slowly stretch it until it fits the piston [Figure 20-21-11].

Allow the seal the stretch for 30 seconds before installing it on the piston.

Use a ring compressor to compress the seal to the correct size. Leave the piston in the compressor for about three minutes.

Figure 20-21-12

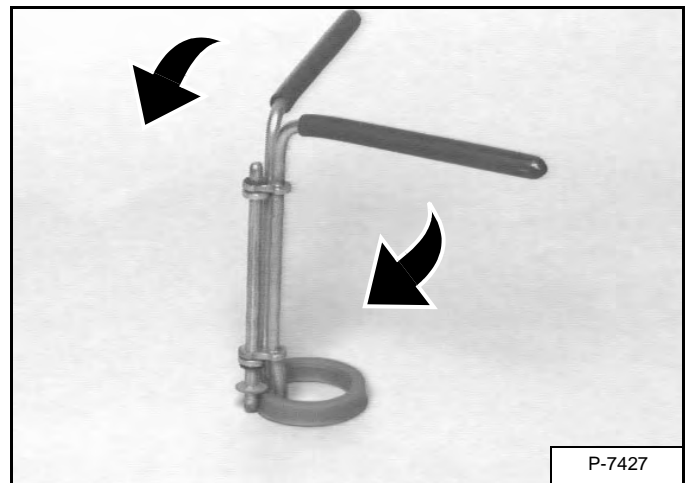

Install the rod seal on the rod seal tool [Figure 20-21-12].

NOTE: During installation the O-ring side of the seal must be toward the inside of the cylinder.

Rotate the handles to collapse the rod seal.

CYLINDER (TILT) (CONT'D)

Disassembly And Assembly (Cont'd)

Figure 20-21-13



Install the rod seal in the head **[Figure 20-21-13]**.

Install the wiper seal with the wiper toward the outside of the head.

Assemble the cylinder(s) in the reverse order.

MAIN RELIEF VALVE

Description

The main relief valve limits the hydraulic system pressure by opening at a certain pressure and allowing the hydraulic oil to flow back to the hydraulic reservoir.

The main relief valve is not adjustable and is located on the hydraulic control valve near the bottom, facing the front of the loader.

MAIN RELIEF VALVE (CONT'D)

Testing Without Auxiliaries

NOTE: The following procedure is for checking the main relief valve only. Use this procedure when it is known that the hydraulic pump is in good working condition. If the hydraulic pump is not working correctly, refer to checking the output of the hydraulic pump. (See HYDRAULIC PUMP on Page 20-60-1.)

WARNING

Put jackstands under the front axles and rear corners of the frame before running the engine for service. Failure to use jackstands can allow the machine to fall or move and cause injury or death.

W-2017-0286

IMPORTANT

The hydraulic tester must be in the fully open position before you start the engine.

I-2024-0284

The tools listed will be needed to do the following procedure:

MEL10003 - Hydraulic Tester
MEL10006 - Hydraulic Test Kit

Lift and block the loader. (See Procedure on Page 10-10-1.)

Figure 20-30-1

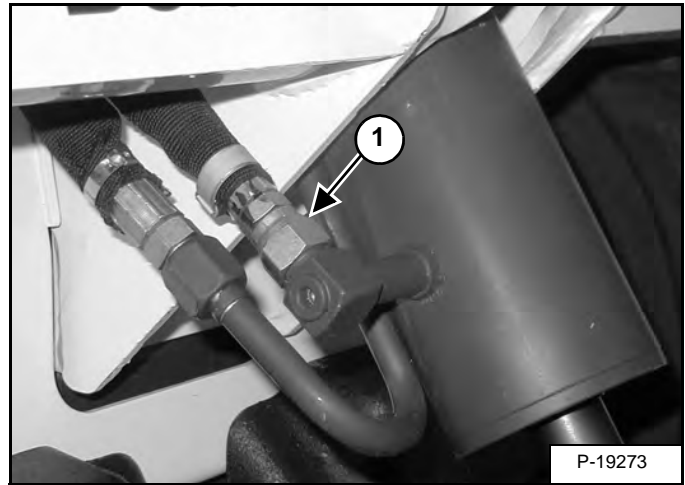

Disconnect the rod end hydraulic hose (Item 1) [Figure 20-30-1] from the tilt cylinder.

Connect the IN port of the hydraulic tester to the rod end hydraulic hose (Item 1) [Figure 20-30-1].

Connect the OUT port of the hydraulic tester to the rod end of the tilt cylinder port. (Where the hydraulic hose was disconnected.)

Check the hose routing, from the tester, for clearance while doing this procedure.

Sit in the operator seat, lower the seat bar and fasten the seat belt.

Start the engine and run at low rpm. Push the bottom (heel) of the right foot pedal to retract the tilt cylinder.

Check for hydraulic leaks. Be sure the tester is showing flow.

Increase the engine speed to full rpm.

Push the bottom (heel) of the right foot pedal until the system relief pressure is reached.

The correct pressure for the main relief valve is 13790 kPa (138 bar) (2000 psi).

If the relief valve pressure is not correct, stop the engine. Replace the main relief valve. (See Removal And Installation on Page 20-30-4.)

When the test is complete return the foot pedal to neutral position, reduce the engine rpm to idle.

Stop the engine.

MAIN RELIEF VALVE (CONT'D)

Testing With Auxiliaries

NOTE: The following procedure is for checking the main relief valve only. Use this procedure when it is known that the hydraulic pump is in good working condition. If the hydraulic pump is not working correctly, refer to checking the output of the hydraulic pump. (See **HYDRAULIC PUMP** on Page 20-60-1.)

The tools listed will be needed to do the following procedure:

MEL10003 - Hydraulic Tester
MEL10006 - Hydraulic Test Kit

Lift and block the loader. (See Procedure on Page 10-10-1.)

WARNING

Put jackstands under the front axles and rear corners of the frame before running the engine for service. Failure to use jackstands can allow the machine to fall or move and cause injury or death.

W-2017-0286

Figure 20-30-2

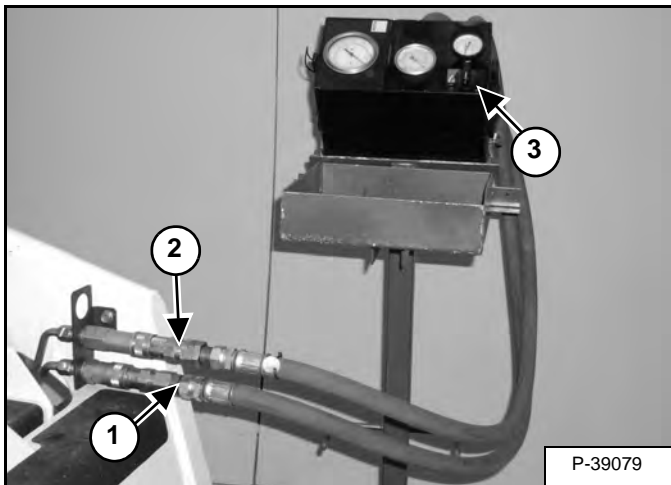

Connect the IN port of the hydraulic tester to the bottom (female) quick coupler (Item 1) [Figure 20-30-2] on the loader.

Connect OUT port of the hydraulic tester to the top (male) quick coupler (Item 2) [Figure 20-30-2] on the loader.

Open the restrictor (Item 3) [Figure 20-30-2] fully (counterclockwise) before testing the relief valve.

IMPORTANT

The hydraulic tester must be in the fully open position before you start the engine.

I-2024-0284

Remove the auxiliary hydraulics lock bolt. (See Procedure on Page 10-140-1.)

Figure 20-30-3

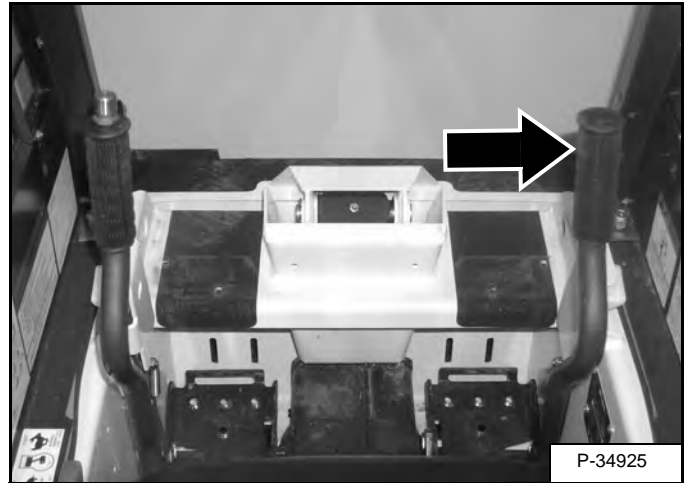

Start the engine and run at low idle rpm. Push the right steering lever all the way to the right to engage the front auxiliary hydraulics *detent* [Figure 20-30-3].

Increase the engine speed to full rpm. Watch the flow meter on the hydraulic tester to make sure the flow is correct.

There should be 33,7 L/min (8.9 U.S. gpm) free flow.

Slowly turn the restrictor control knob (Item 3) [Figure 20-30-2], on the tester, until the main relief valve opens. Record the pressure reading. The correct pressure for the main relief valve is 20684 kPa (207 bar) (3000 psi).

MAIN RELIEF VALVE (CONT'D)

Removal And Installation

Raise the operator cab. (See Raising on Page 10-30-2.)

Figure 20-30-4

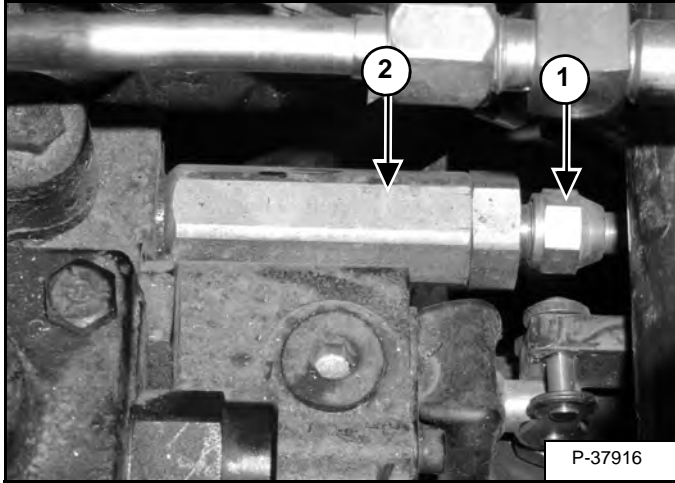

Clean the area around the control valve. Remove the pilot hose (Item 1) from the main relief valve. Remove the main relief valve (Item 2) [Figure 20-30-4].

Installation: Tighten the main relief valve to 47 - 54 N•m (35 - 40 ft-lb) torque.

IMPORTANT

When repairing hydrostatic and hydraulic systems, clean the work area before disassembly and keep all parts clean. Always use caps and plugs on hoses, tubelines and ports to keep dirt out. Dirt can quickly damage the system.

I-2003-0888

Figure 20-30-5

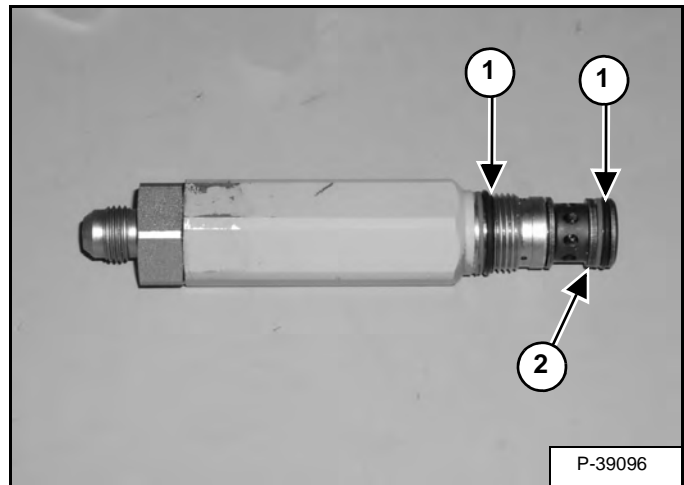

Remove the O-rings (Item 1) and back-up ring (Item 2) [Figure 20-30-5]. Install new O-rings and back-up ring.

HYDRAULIC CONTROL VALVE

Description

The hydraulic control valve is located inside the main frame, below the operator cab.

The hydraulic control valve is the component that uses spools to direct the flow of hydraulic fluid to the lift, tilt and auxiliary functions. A separate BICS™ valve is mounted to the hydraulic control valve.

The lift and tilt functions are operated using mechanical linkages to connect the foot pedals to the lift and tilt spools.

The auxiliary functions are operated using mechanical linkages to connect the right steering lever to the auxiliary spool. Move the lever to the right or left to activate the auxiliary hydraulics.

HYDRAULIC CONTROL VALVE (CONT'D)

BICS™ Valve Removal And Installation

Figure 20-40-1

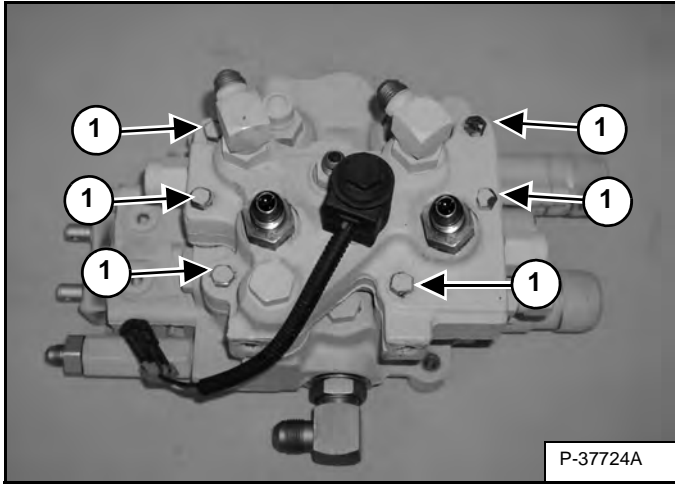

Remove the control valve from the loader. (See Removal And Installation on Page 20-40-8.)

Remove the six mounting bolts (Item 1) [Figure 20-40-1] to remove the BICS™ valve from the control valve. Note the bolt locations.

Figure 20-40-2

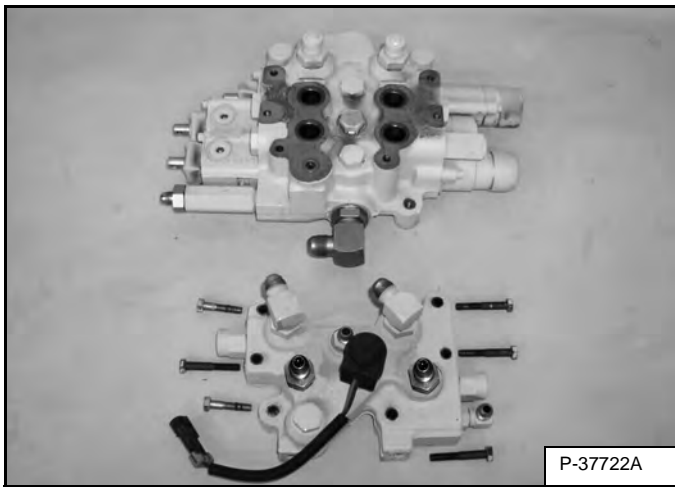

Remove the BICS™ valve assembly from the top of the control valve [Figure 20-40-2].

Figure 20-40-3

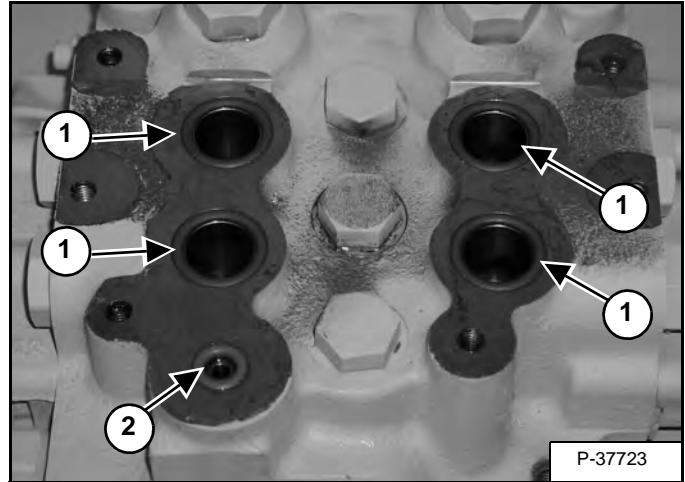

Remove and discard the four large O-rings (Item 1) and the small O-ring (Item 2) [Figure 20-40-3] from the top of the control valve.

Install new O-rings during assembly.

Figure 20-40-4

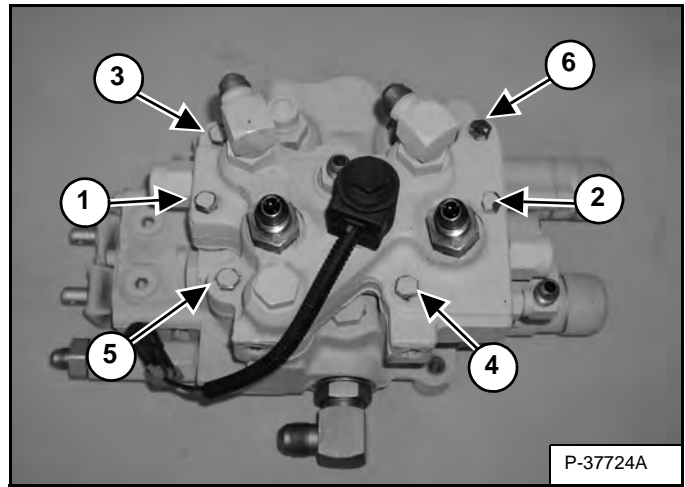

Install the six mounting bolts [Figure 20-40-4].

The chart below lists the correct torque specifications and tightening sequence when reinstalling the BICS™ valve assembly to the control valve. Thoroughly clean and dry the bolts and the threads in the valve. Use liquid adhesive Loctite® #242 or equivalent.

STEP	TORQUE	SEQUENCE
1	12,4 - 14,7 N•m (110 - 130 in-lb)	1, 2, 3, 4, 5 and 6
2	21,5 - 23,7 N•m (190 - 210 in-lb)	
3*	21,5 - 23,7 N•m (190 - 210 in-lb)	

*Torque must be 21,5 - 23,7 N•m (190 - 210 in-lb) for every bolt or repeat step 3.

HYDRAULIC CONTROL VALVE (CONT'D)

BICS™ Valve, Lift Arm Bypass Orifice Removal And Installation

Figure 20-40-5

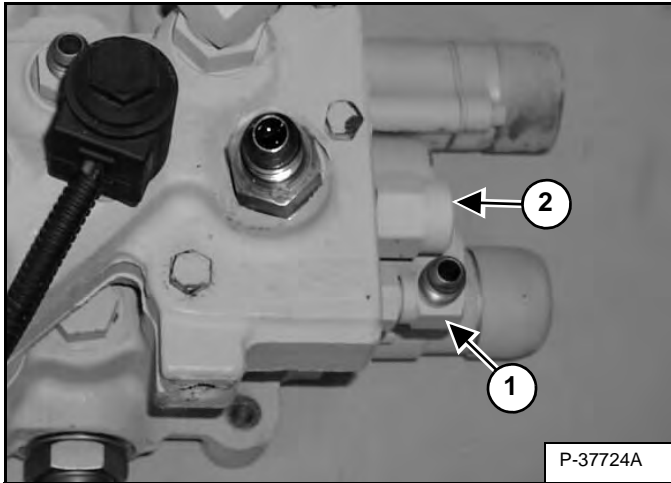

The lift arm bypass orifice is located in the port with the 90 degree fitting (Item 1) [Figure 20-40-5].

The pressure differential / check valve (Item 2) must be removed to remove the fitting (Item 1) [Figure 20-40-5].

Figure 20-40-6

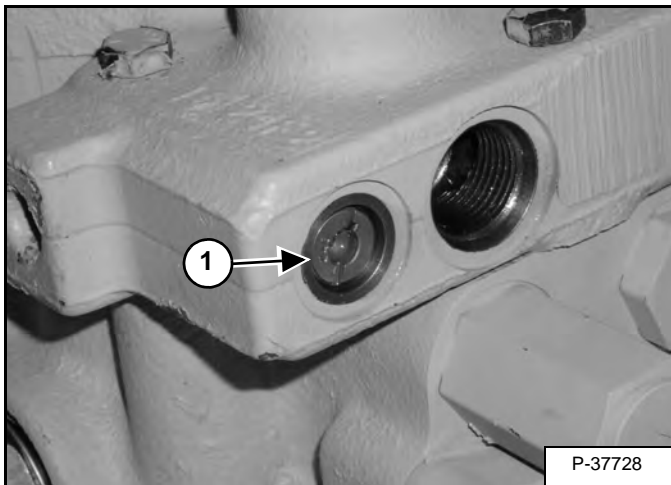

Use a flat blade screw driver to remove the lift arm bypass orifice (Item 1) [Figure 20-40-6] from the BICS™ valve.

Figure 20-40-7

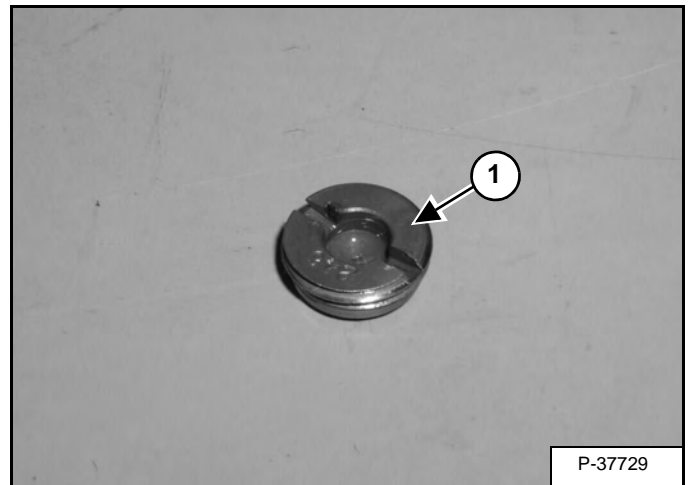

Check the condition of the orifice (Item 1) [Figure 20-40-7] and replace if needed.

The orifice hole must be 1,994 mm (0.0785 in) diameter.

HYDRAULIC CONTROL VALVE (CONT'D)

Pressure Differential Valve Removal And Installation

Figure 20-40-8

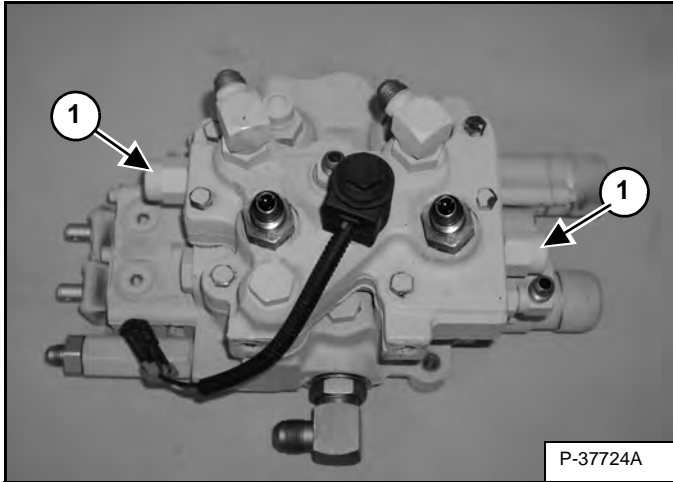

Remove the two pressure differential valves (Item 1) [Figure 20-40-8] from the BICS™ valve.

Figure 20-40-9

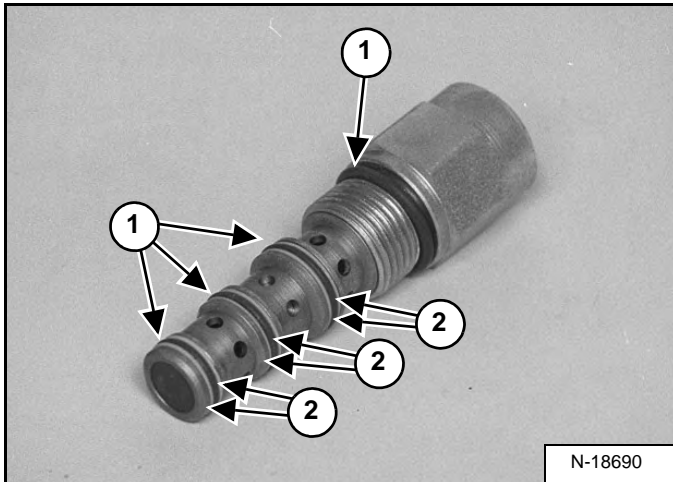

Remove the O-rings (Item 1) and back-up rings (Item 2) [Figure 20-40-9] from both the tilt pressure differential valve.

Install new O-rings and back-up rings during assembly.

HYDRAULIC CONTROL VALVE (CONT'D)

BICS™ Valve, Check Valve Removal And Installation

Figure 20-40-10

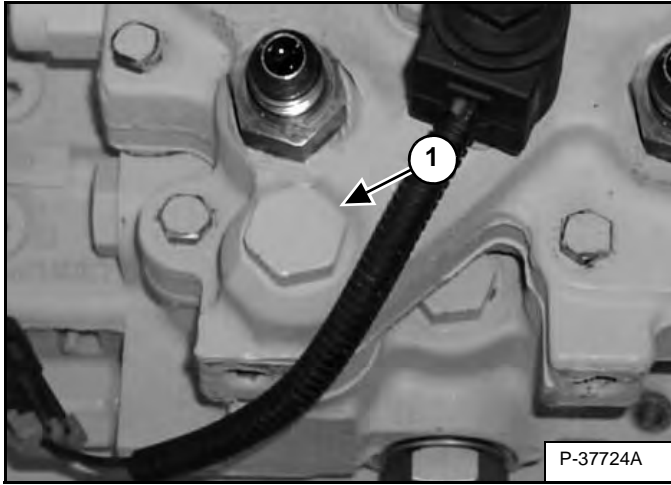

Remove the check valve (Item 1) [Figure 20-40-10].

Installation: Tighten the valve to 30 N•m (22 ft-lb) torque.

Figure 20-40-11

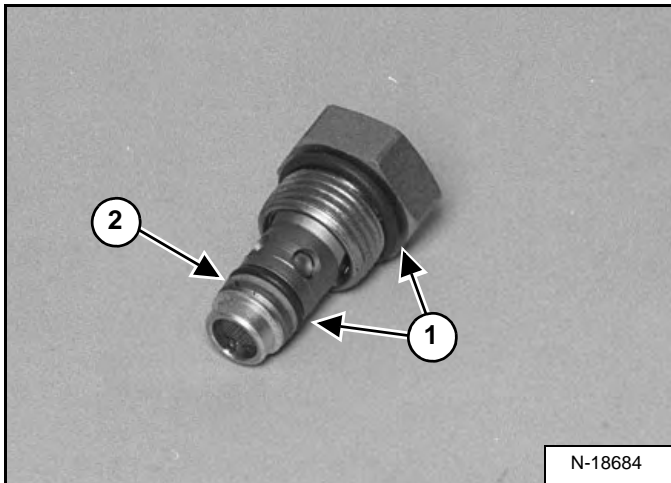

Remove the O-rings (Item 1) and back-up ring (Item 2) [Figure 20-40-11] from the check valve.

Install new O-rings and back-up ring on the check valve.

Figure 20-40-12

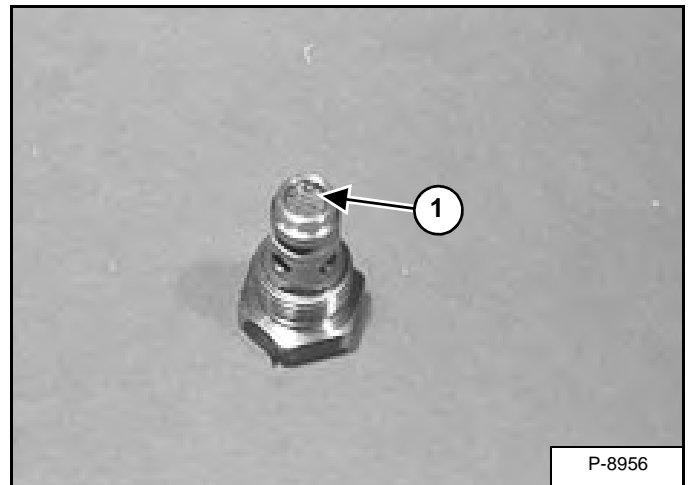

Clean and inspect the screen (Item 1) [Figure 20-40-12] on the end of the valve.

HYDRAULIC CONTROL VALVE (CONT'D)

BICS™ Valve, Solenoid Removal And Installation

Figure 20-40-13

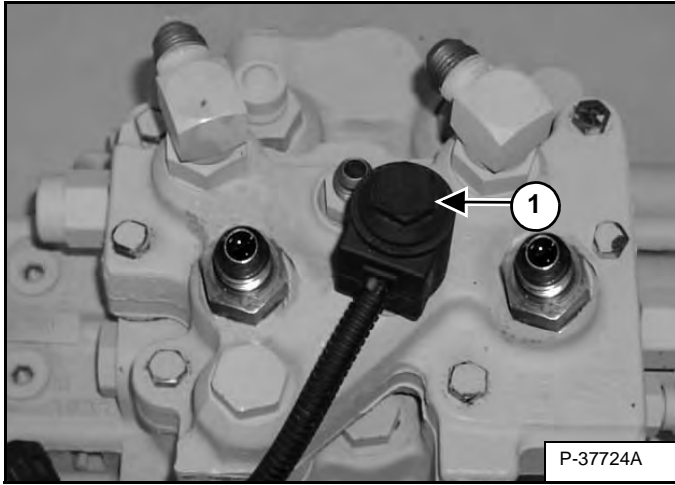

Remove the mounting nut (Item 1) [Figure 20-40-13] from the solenoid stem.

Installation: Tighten the nut to 6 N•m (53 in-lb) torque.

Remove the coil.

Figure 20-40-14

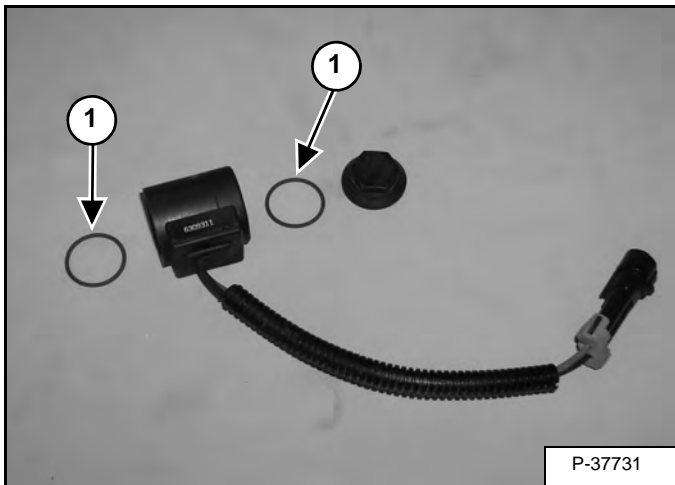

Remove the O-rings (Item 1) [Figure 20-40-14] from both ends of the coil.

Figure 20-40-15

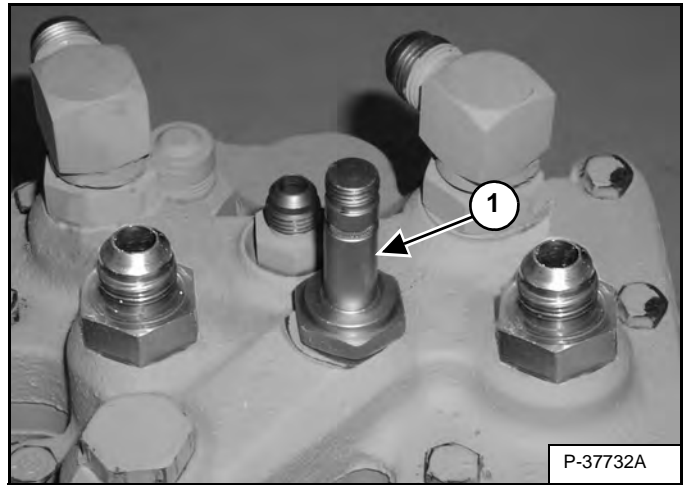

Remove the solenoid stem (Item 1) [Figure 20-40-15].

Installation: Tighten the solenoid stem to 29,8 N•m (22 ft-lb) torque.

Figure 20-40-16

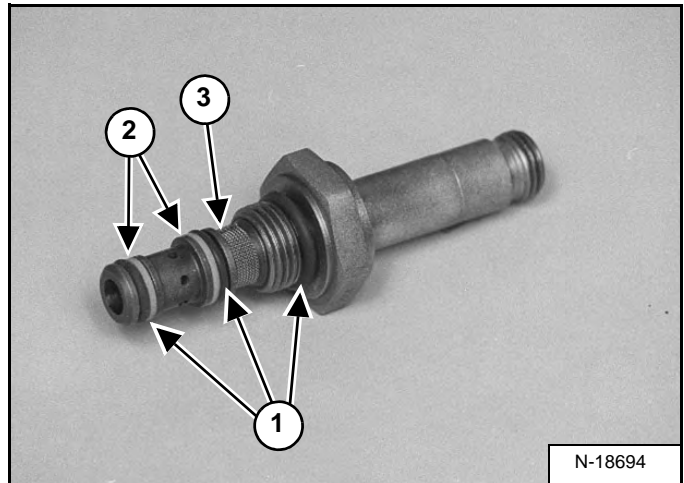

Remove the O-rings (Item 1) and back-up rings (Item 2) [Figure 20-40-16] from the solenoid stem.

Clean the solenoid stem in solvent and dry with compressed air.

Inspect the solenoid stem for wear and replace if it is showing excessive wear.

NOTE: The screen (Item 3) [Figure 20-40-16] may be cleaned with solvent. If it is torn or worn replace the solenoid stem.

Apply oil to the new O-rings and back-up rings and install on the solenoid stem.

HYDRAULIC CONTROL VALVE (CONT'D)

BICS™ Valve, Solenoid Testing

Figure 20-40-17



Use a test meter to measure the coil resistance [Figure 20-40-17]. Coil wires do not have polarity. Correct resistance for the coil is 7 - 10 ohm.

Replace the test meter with 12 volt power. You can see and hear the spool shift.

BICS™ Valve, Identification Chart

Figure 20-40-18

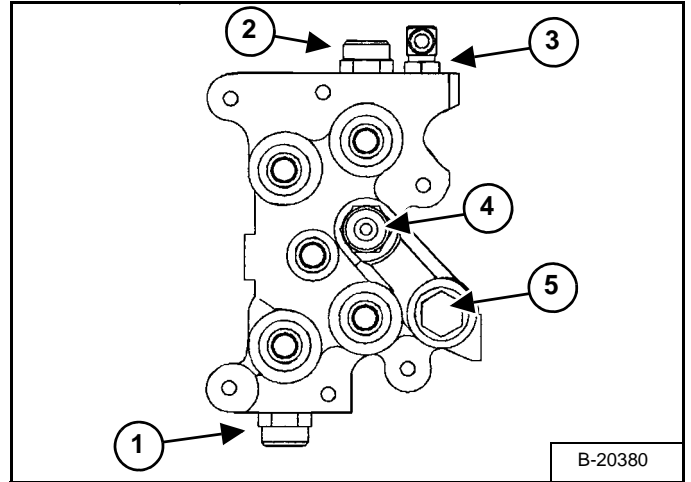

Item	S70
1	Tilt Cylinder Rod End Lock Valve
2	Lift Cylinder Base End Lock Valve
3	Orifice
4	Solenoid
5	Check Valve

HYDRAULIC CONTROL VALVE (CONT'D)

Removal And Installation

! DANGER

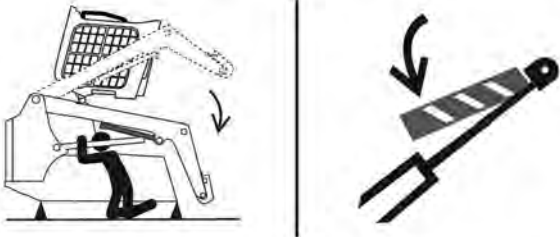

P-90328

AVOID DEATH

- Disconnecting or loosening any hydraulic tubeline, hose, fitting, component or a part failure can cause lift arms to drop.
- Keep out of this area when lift arms are raised unless supported by an approved lift arm support. Replace if damaged.

D-1009-0409

! WARNING

Never work on a machine with the lift arms up unless the lift arms are secured by an approved lift arm support device. Failure to use an approved lift arm support device can allow the lift arms or attachment to fall and cause injury or death.

W-2059-0598

IMPORTANT

When repairing hydrostatic and hydraulic systems, clean the work area before disassembly and keep all parts clean. Always use caps and plugs on hoses, tubelines and ports to keep dirt out. Dirt can quickly damage the system.

I-2003-0888

Install jackstands under the rear corners of the loader. (See Procedure on Page 10-10-1.)

Raise the operator cab. (See Raising on Page 10-30-2.)

Remove the center control shield and the steering lever covers. (See Control Shield And Steering Lever Panels Removal And Installation on Page 50-90-1.)

Remove the steering levers. (See Lever Removal And Installation on Page 50-100-1.)

Thoroughly clean the control valve area.

Figure 20-40-19

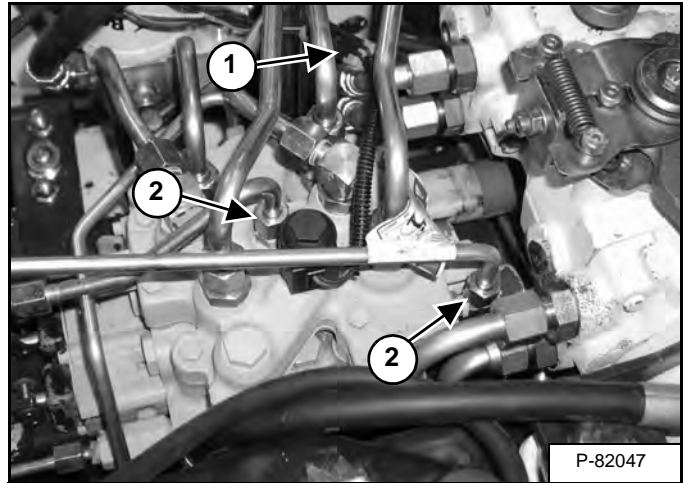

P-82047

Disconnect the solenoid connector (Item 1) and remove the two tubelines (Item 2) [Figure 20-40-19] that route to the lift arm bypass control valve.

Figure 20-40-20

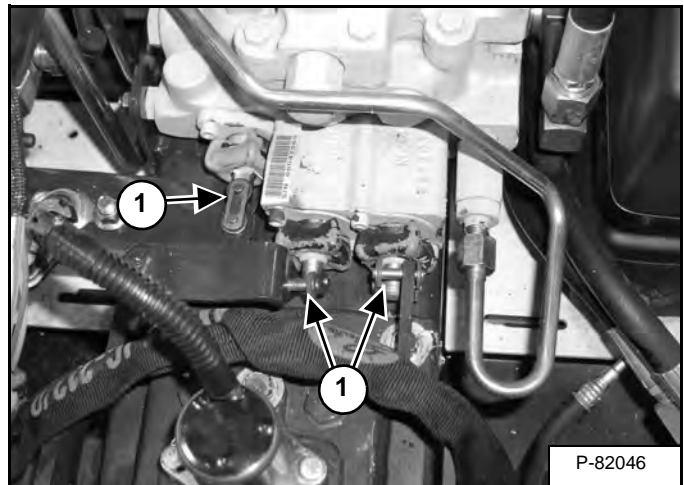

P-82046

Remove the hair pins and the fastener links (Item 1) [Figure 20-40-20] from the three spools in the control valve spool.

HYDRAULIC CONTROL VALVE (CONT'D)

Removal And Installation (Cont'd)

Figure 20-40-21

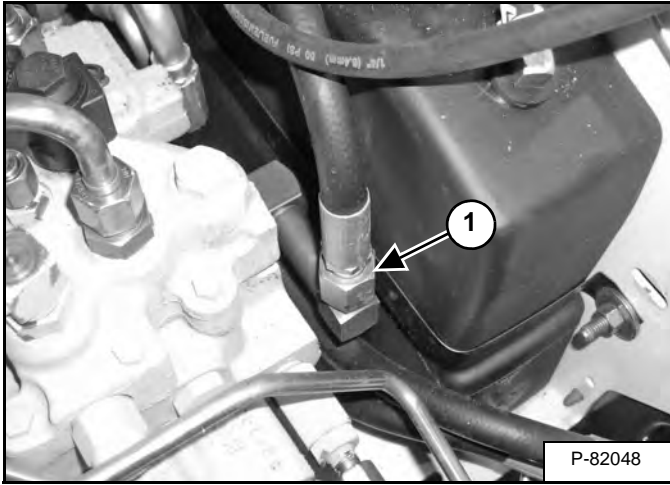

Remove the inlet hose (Item 1) [Figure 20-40-21] from the control valve.

Figure 20-40-22

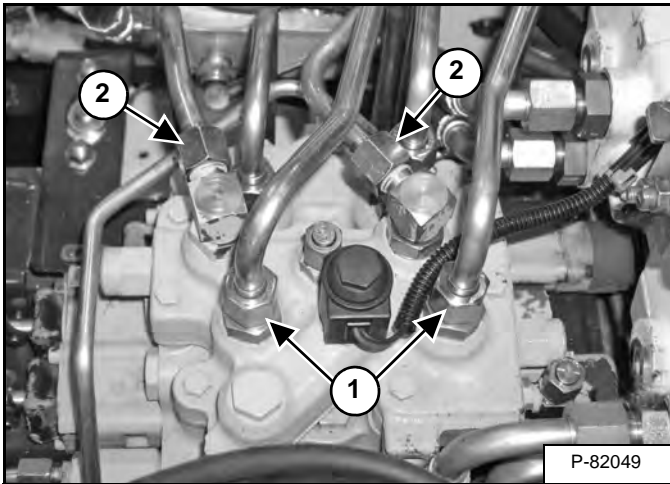

Remove the lift tubelines (Item 1) [Figure 20-40-22] from the control valve.

Remove the tilt tubelines (Item 2) [Figure 20-40-22] from the control valve.

Figure 20-40-23

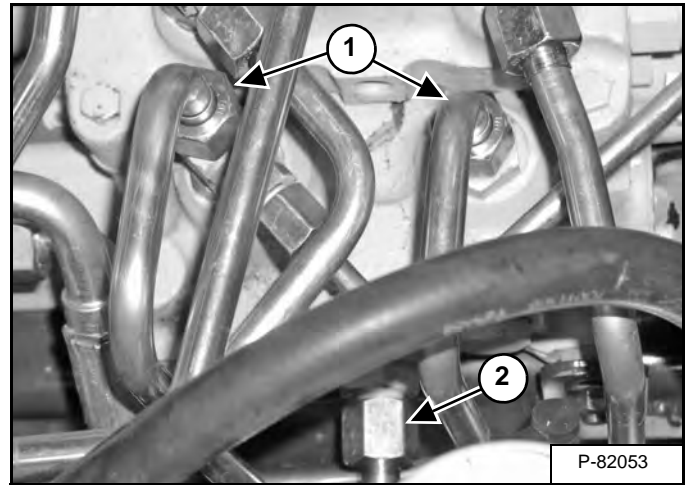

Remove the auxiliary tubelines (Item 1) [Figure 20-40-23] from the control valve.

Remove the outlet tubeline (Item 2) [Figure 20-40-23] from the control valve.

Figure 20-40-24

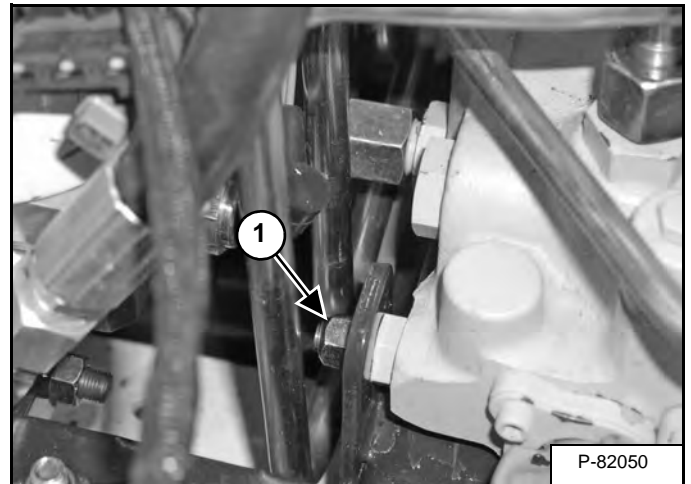

Remove the nut (Item 1) [Figure 20-40-24] from the mounting bracket on the right front corner of the control valve.

HYDRAULIC CONTROL VALVE (CONT'D)

Removal And Installation (Cont'd)

Figure 20-40-25

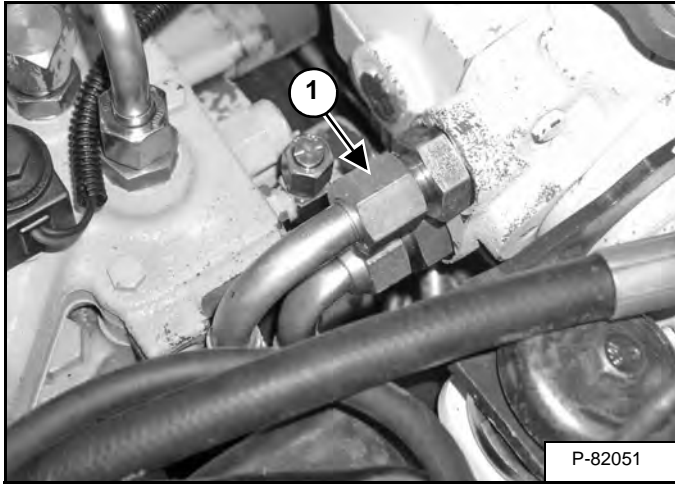

Remove the top left drive motor hose (Item 1) [Figure 20-40-25] from the hydrostatic pump.

Figure 20-40-26

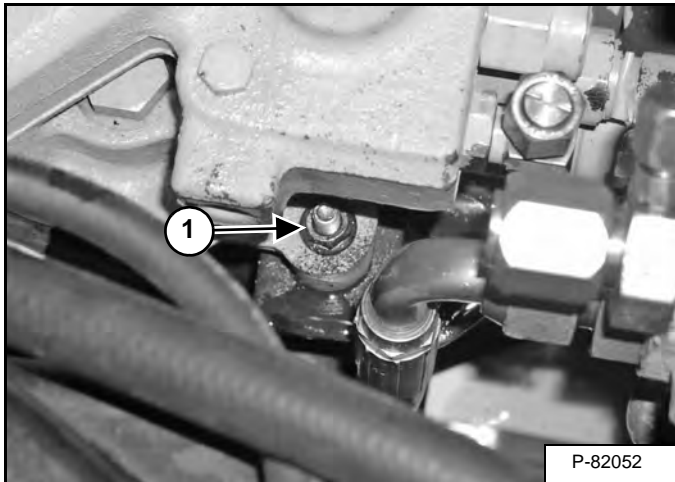

Remove the left rear mounting bolt (Item 1) [Figure 20-40-26] from the control valve.

Lift and pull the control valve forward to remove it from the loader.

Identification Chart

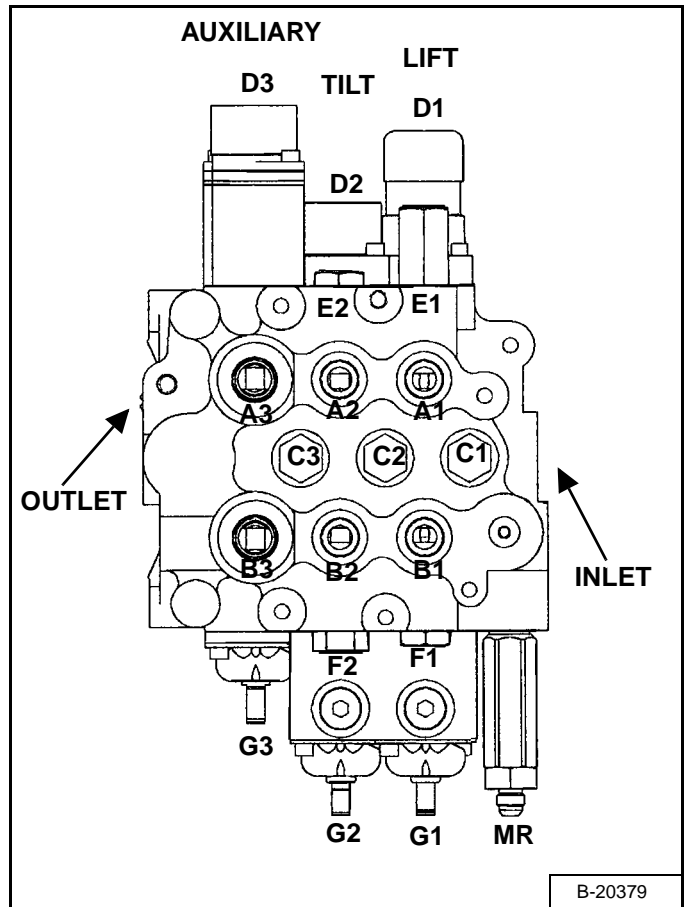

ITEM	S70
A1	Lift Cylinder Base End
A2	Tilt Cylinder Base End
A3	Auxiliary Hydraulics
B1	Lift Cylinder Rod End
B2	Tilt Cylinder Rod End
B3	Auxiliary Hydraulics
C1	Load Check Valve / Lift Function
C2	Load Check Valve / Tilt Function
C3	Load Check Valve / Auxiliary Function
D1	Lift Spool Detent
D2	Centering Spring Tilt Spool
D3	Auxiliary Spool Detent
E1	Port Relief / Anti-Cavitation Valve
E2	Anti-Cavitation / Check Valve
F1	Anti-Cavitation / Check Valve
F2	Plug
G1	Lift Spool
G2	Tilt Spool
G3	Auxiliary Spool
MR	Main Relief Valve

HYDRAULIC CONTROL VALVE (CONT'D)

Disassembly And Assembly

(See Identification Chart on Page 20-40-10.) for the control valve parts assembly.

IMPORTANT

When repairing hydrostatic and hydraulic systems, clean the work area before disassembly and keep all parts clean. Always use caps and plugs on hoses, tubelines and ports to keep dirt out. Dirt can quickly damage the system.

I-2003-0888

Mark each valve section and spool so that the parts will be returned to their original bore during assembly.

Use bolts to fasten the control valve to a work bench for easier disassembly and assembly.

Load Check Valves Removal And Installation

Figure 20-40-27

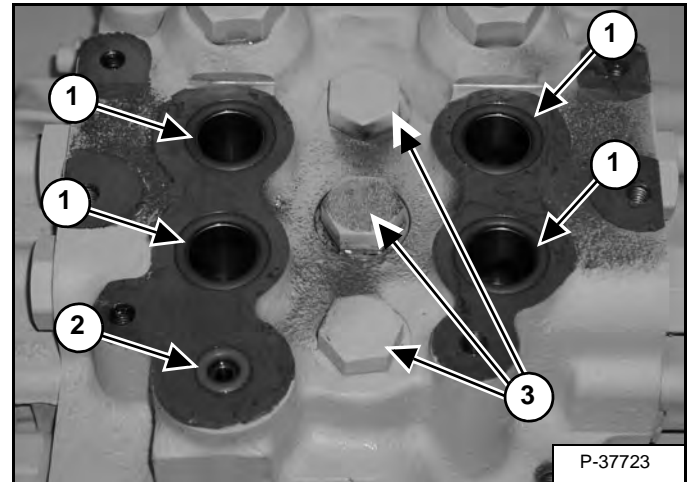

Remove the BICST™ valve assembly from the control valve. (See BICST™ Valve Removal And Installation on Page 20-40-2.)

Remove and discard the four large O-rings (Item 1) and small O-ring (Item 2) [Figure 20-40-27] from the top of the control valve. Install new O-rings during assembly.

Loosen the load check plug (Item 3) [Figure 20-40-27].

Assembly: Always use new O-rings. Tighten the plugs to 47 - 54 N•m (35 - 40 ft-lb) torque.

Figure 20-40-28

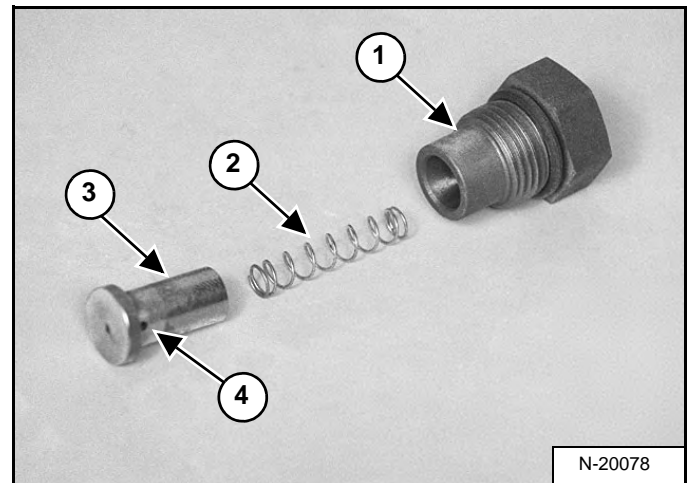

Remove the load check plug (Item 1), spring (Item 2), and poppet (Item 3) [Figure 20-40-28].

All poppets have an orifice (Item 4) [Figure 20-40-28].

HYDRAULIC CONTROL VALVE (CONT'D)

Main Relief Valve Removal And Installation

NOTE: The main relief valve is non-adjustable.

Figure 20-40-29

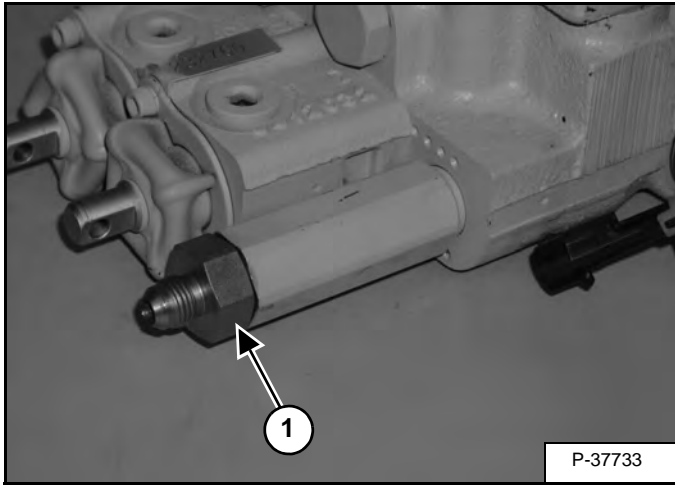

Remove the main relief valve adapter fitting (Item 1) [Figure 20-40-29].

Figure 20-40-30

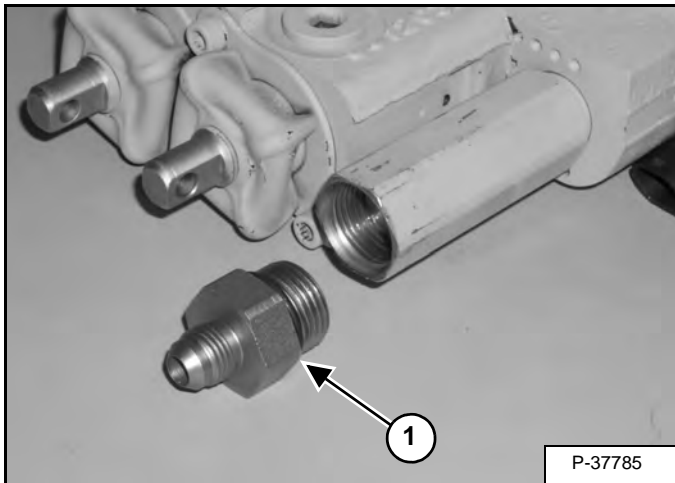

Remove the O-ring from the main relief valve adapter fitting (Item 1) [Figure 20-40-30].

Figure 20-40-31

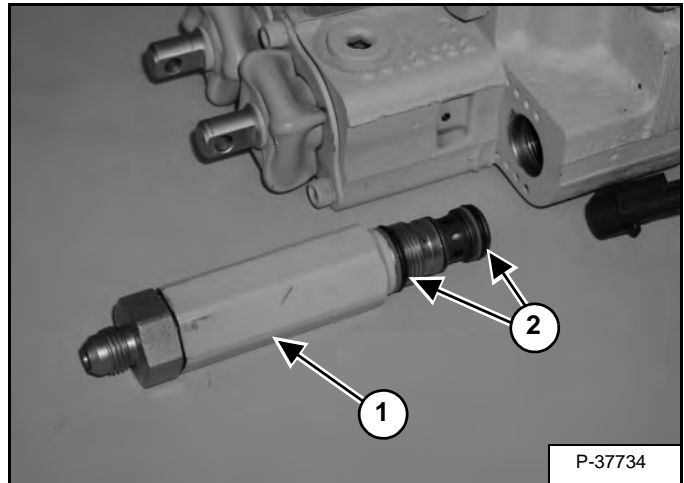

Remove the main relief valve (Item 1) [Figure 20-40-31] from the control valve.

Remove the O-rings and back-up washers (Item 2) [Figure 20-40-31] from the main relief valve.

Assembly: Always use new O-rings and back-up rings (Item 2) [Figure 20-40-31]. Tighten to 47 - 54 N•m (35 - 40 ft-lb) torque.

HYDRAULIC CONTROL VALVE (CONT'D)

Port Relief / Anti-Cavitation Valve Removal And Installation

Figure 20-40-32

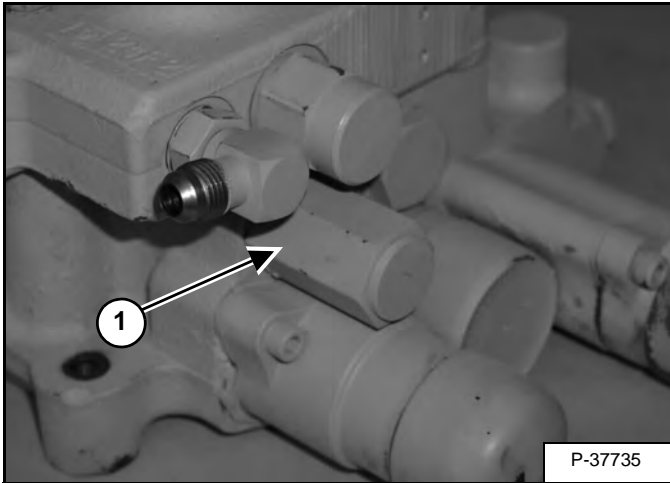

Remove the Port Relief / Anti-Cavitation valve (Item 1) [Figure 20-40-32].

Assembly: Always use new O-rings and back-up rings. Tighten to 47 - 54 N•m (35 - 40 ft-lb) torque.

Figure 20-40-33

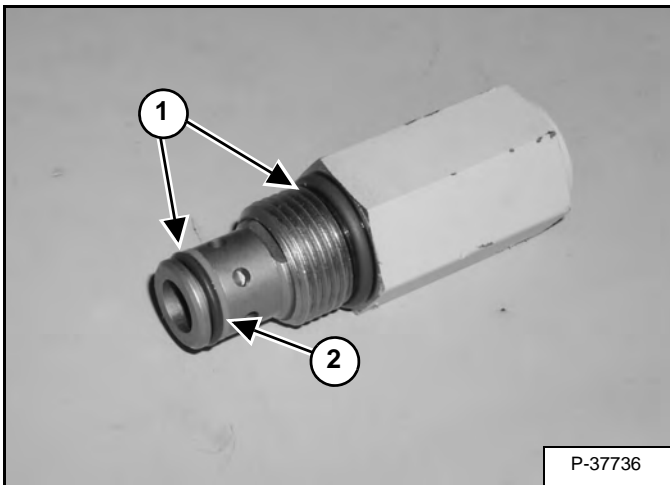

Remove the O-rings (Item 1), and back-up rings (Item 2) [Figure 20-40-33] from the Port Relief / Anti-Cavitation valve.

HYDRAULIC CONTROL VALVE (CONT'D)

Anti-Cavitation / Check Valves Removal And Installation

Figure 20-40-34

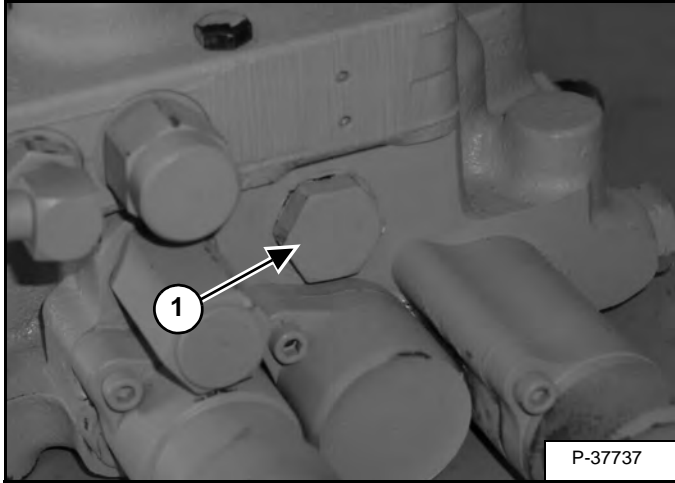

Remove the Anti-Cavitation / Check valve (Item 1) [Figure 20-40-34] from the tilt cylinder base end port.

Figure 20-40-35

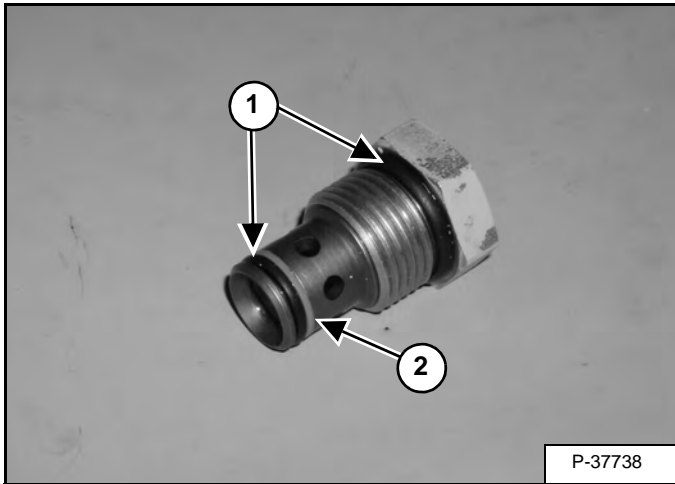

Remove the O-rings (Item 1), and back-up ring (Item 2) [Figure 20-40-35] from the Anti-Cavitation / Check valve.

Assembly: Always use new O-rings and back-up ring. Tighten to 47 - 54 N•m (35 - 40 ft-lb) torque.

Figure 20-40-36

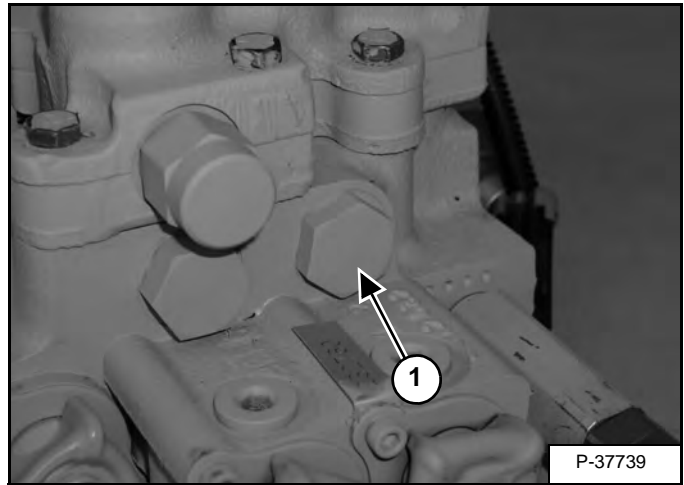

Remove the Anti-Cavitation / Check valve (Item 1) [Figure 20-40-36] from the lift cylinder rod end port.

Figure 20-40-37

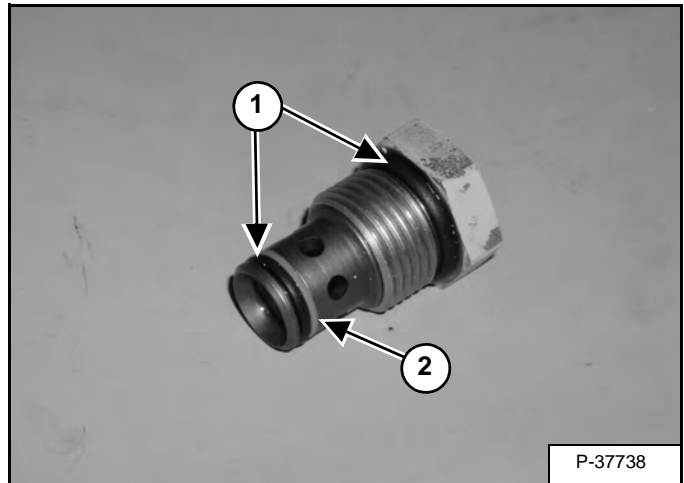

Remove the O-rings (Item 1), and back-up ring (Item 2) [Figure 20-40-37] from the Anti-Cavitation / Check valve.

Assembly: Always use new O-rings and back-up ring. Tighten to 47 - 54 N•m (35 - 40 ft-lb) torque.

HYDRAULIC CONTROL VALVE (CONT'D)

Rubber Boot Removal And Installation

Figure 20-40-38

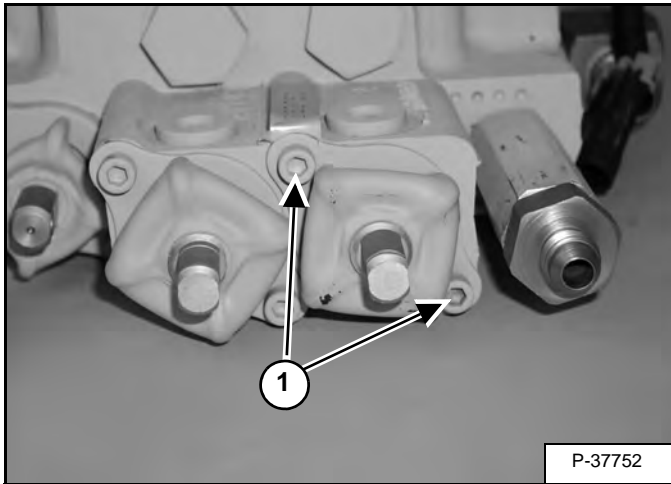

Remove the two screws (Item 1) [Figure 20-40-38] from the rubber boot retainer.

Assembly: Tighten the screws to 10,2 - 11,3 N•m (90 - 100 ft-lb) torque.

Figure 20-40-39

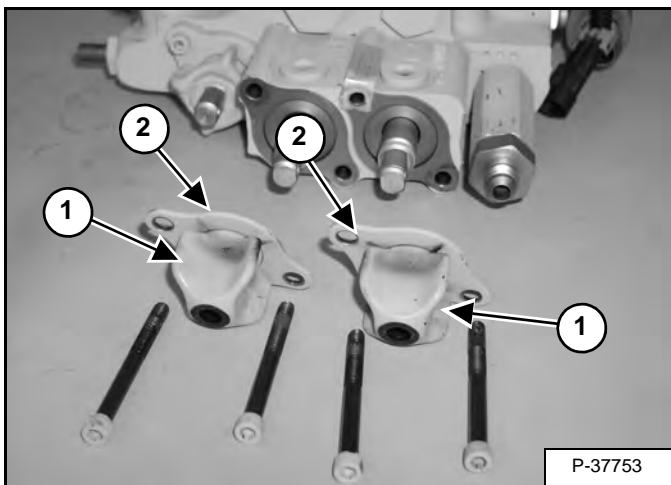

Remove the rubber boots (Item 1) and boot retainers (Item 2) [Figure 20-40-39].

Lift And Tilt Lock Block Removal And Installation

Figure 20-40-40



Remove the lift and tilt lock block [Figure 20-40-40].

HYDRAULIC CONTROL VALVE (CONT'D)

Lift Spool And Detent Removal And Installation

Figure 20-40-41

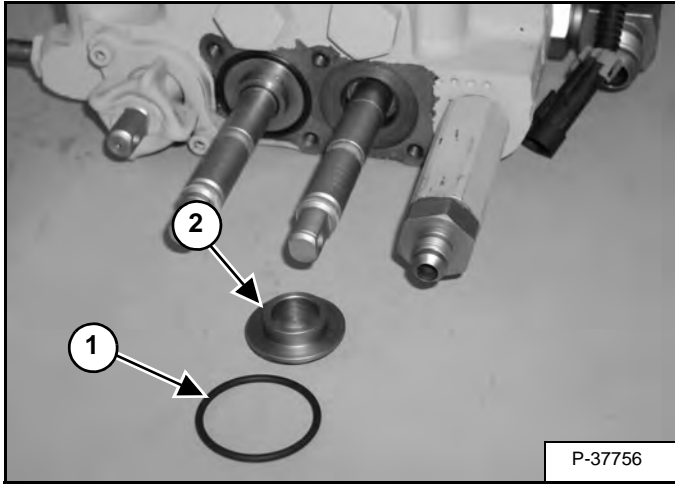

The tool listed will be needed to do the following procedure:

MEL1278 - Detent Tool

MEL1285 - Detent Spring Tool

Remove the lift and tilt lock block. (See Lift And Tilt Lock Block Removal And Installation on Page 20-40-15.)

Remove the O-ring (Item 1) and bushing (Item 2) [Figure 20-40-41].

Figure 20-40-42

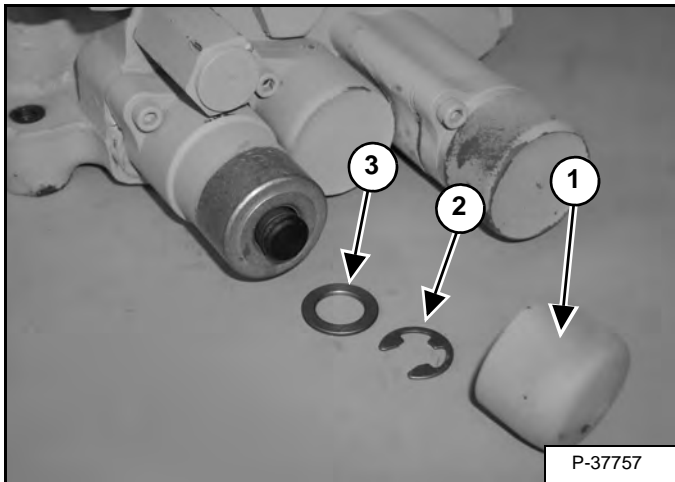

Remove the end cap (Item 1). Use a screw driver to remove the snap ring (Item 2). Remove the washer (Item 3) [Figure 20-40-42].

Figure 20-40-43

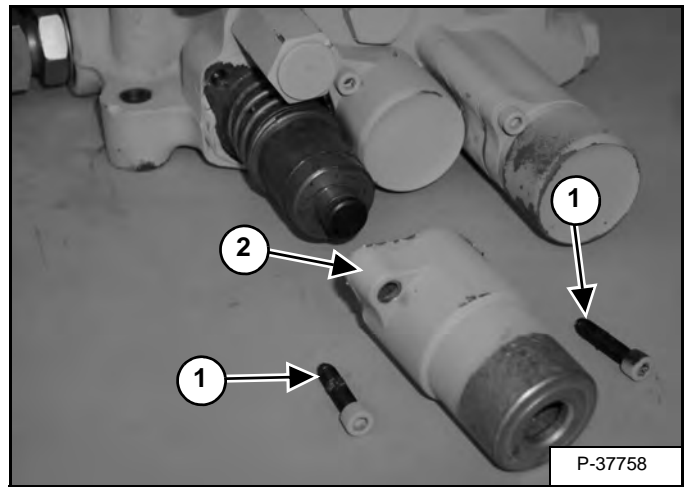

Remove the screws (Item 1) from the detent bonnet. Remove the detent bonnet (Item 2) [Figure 20-40-43] from the detent bonnet. Remove the detent bonnet.

Installation: Tighten the screws to 10,2 - 11,3 N•m (90 - 100 in-lb) torque.

IMPORTANT

The detent assembly has small springs and balls. Do not lose these parts during disassembly and assembly.

I-2012-0284

Figure 20-40-44

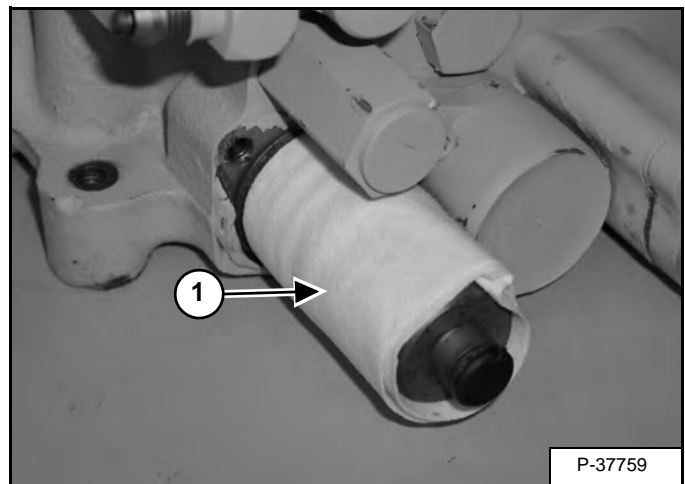

Wrap a rag around the detent assembly (Item 1) [Figure 20-40-44]. This will prevent the detent balls and spring from being lost when the detent sleeve is removed.

HYDRAULIC CONTROL VALVE (CONT'D)

Lift Spool And Detent Removal And Installation (Cont'd)

Figure 20-40-45

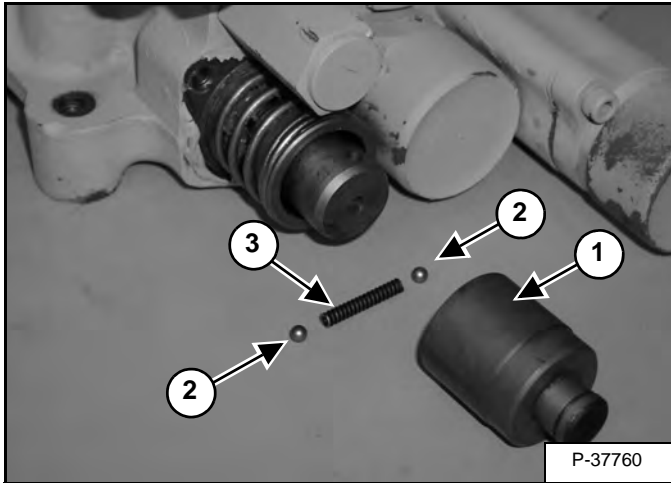

Remove the detent sleeve (Item 1), detent balls (Item 2), and spring (Item 3) [Figure 20-40-45].

Figure 20-40-46

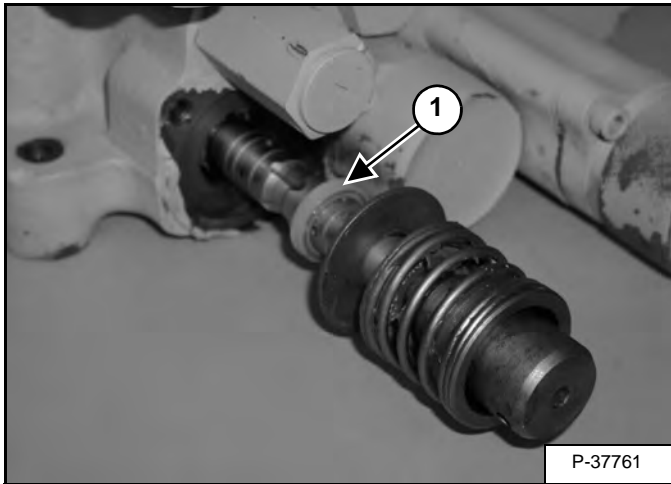

Remove the spool assembly and seal (Item 1) [Figure 20-40-46].

Figure 20-40-47

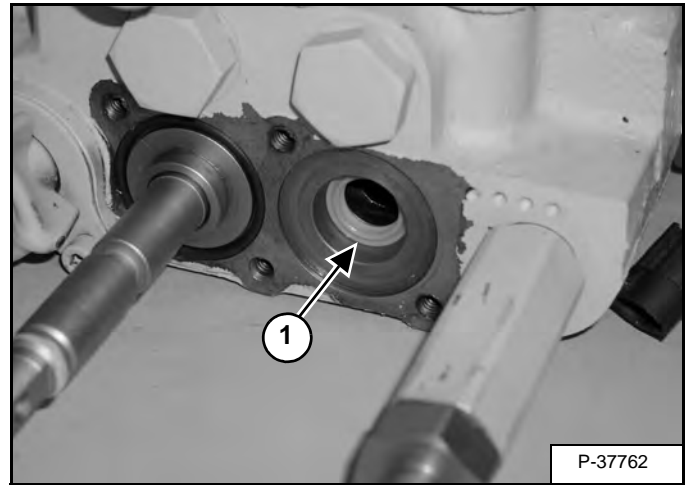

Remove the spool seal (Item 1) [Figure 20-40-47] from the linkage end of the control valve.

HYDRAULIC CONTROL VALVE (CONT'D)

Lift Spool And Detent Disassembly

Figure 20-40-48

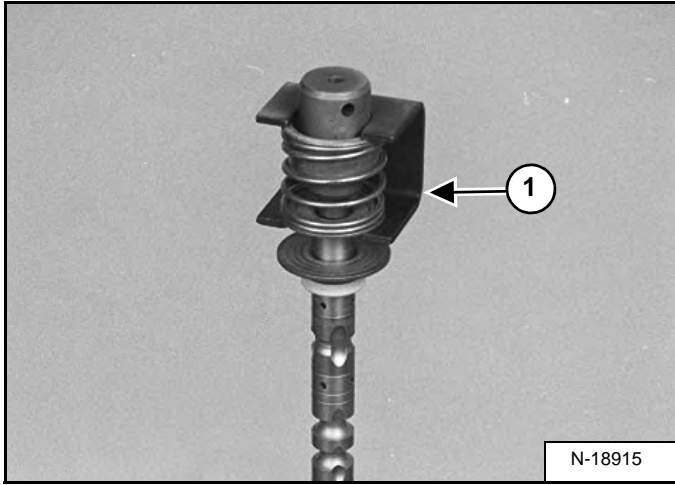

Put the linkage end of the spool assembly [Figure 20-40-48] in a vise.

Install MEL1285 Spring Compressor Tool (Item 1) [Figure 20-40-48] on the spring assembly.

Figure 20-40-49

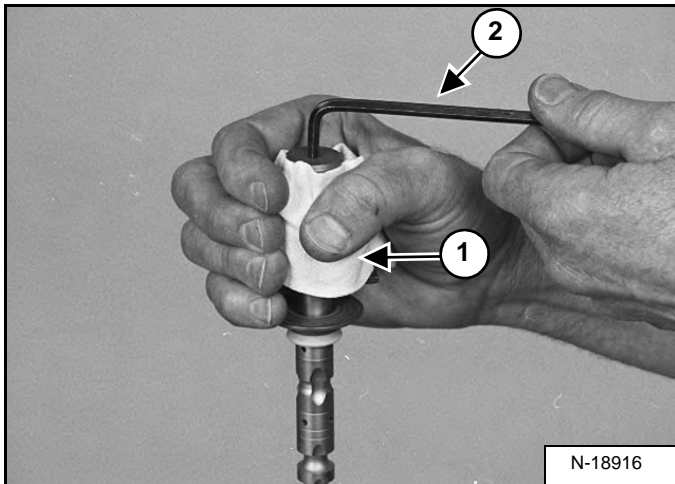

Put a rag around the detent assembly (Item 1) [Figure 20-40-49] to prevent losing the two detent balls when the detent adapter is removed.

NOTE: Be careful when removing the detent adapter from the centering spring, the spring is under pressure.

Use an Allen wrench (Item 2) [Figure 20-40-49] to remove the detent adapter.

Figure 20-40-50

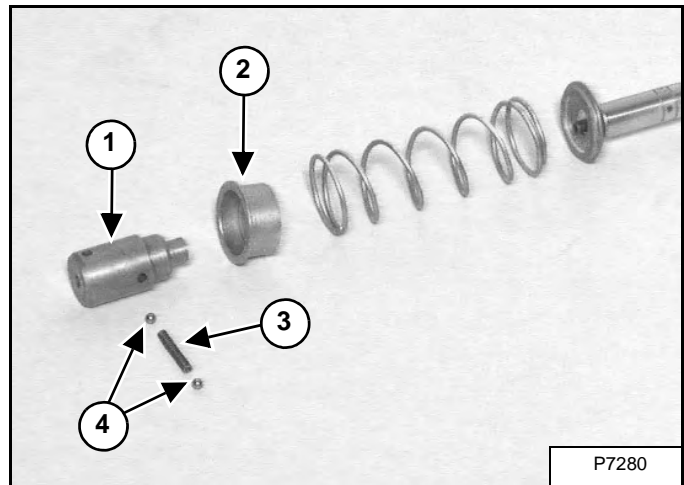

Remove the detent adapter (Item 1) from the adapter retainer (Item 2) [Figure 20-40-50].

Remove the detent spring (Item 3) and detent balls (Item 4) [Figure 20-40-50].

Figure 20-40-51

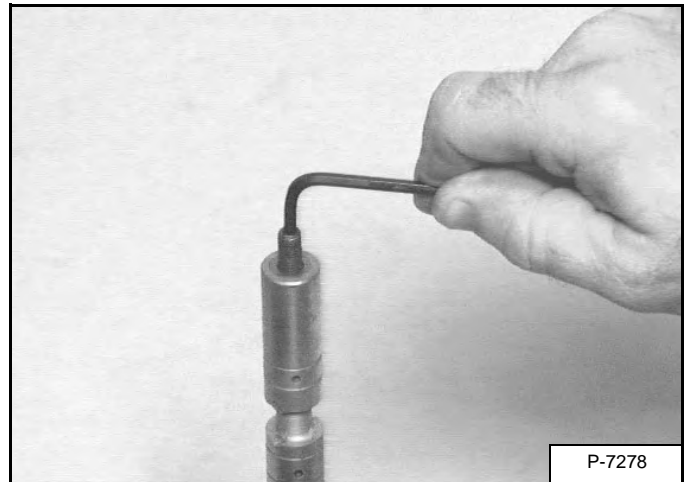

Lift Spool Only: Remove the stud from the end of the spool [Figure 20-40-51].

HYDRAULIC CONTROL VALVE (CONT'D)

Lift Spool And Detent Disassembly (Cont'd)

Figure 20-40-52

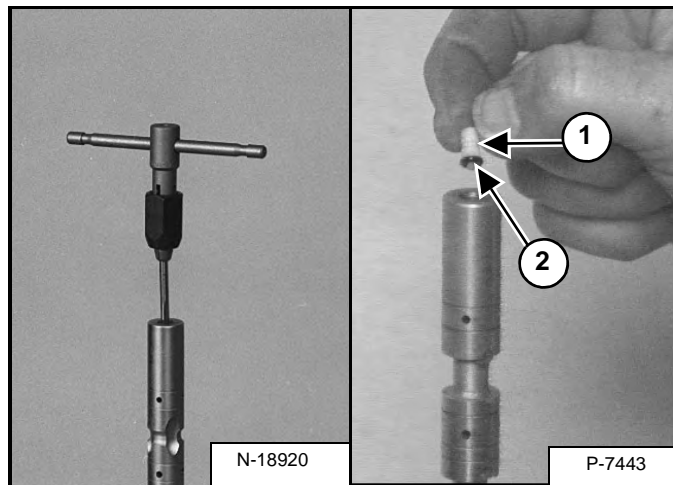

Removal of plastic plug.

- Make a center point in the plug using a 3/16 in. drill.
- Drill a hole all the way through the plug using a 7/64 inch tap drill.
- Turn a 6 - 62 tap into the plug **[Figure 20-40-52]**. Pull the tap and plug out of the spool. BE CAREFUL, do not break the tap.
- Clean all the debris from the inside of the spool bore.

Assembly: Install the new plastic plug (Item 1) and O-ring (Item 2) **[Figure 20-40-52]**.

HYDRAULIC CONTROL VALVE (CONT'D)

Lift Spool And Detent Assembly

Figure 20-40-53

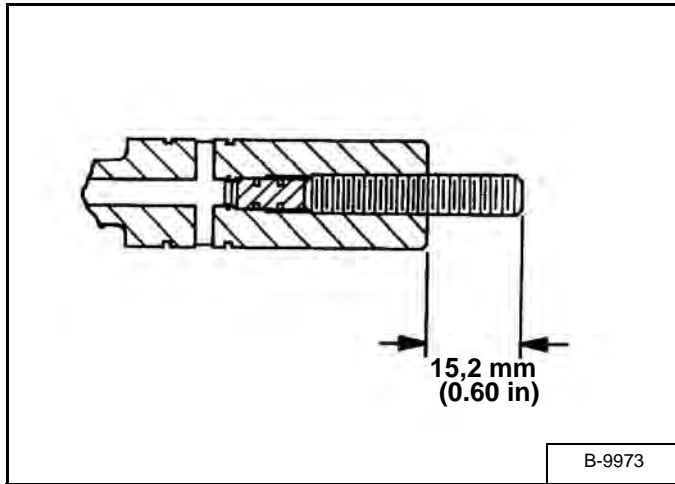

Install the stud and leave 15,2 mm (0.600 in) past the end of the spool [Figure 20-40-53].

NOTE: DO NOT USE Loctite® ON THE STUD THREADS. DO NOT EXCEED 8 N•m (70 in-lb) torque during stud installation. Excess torque may cause spool distortion resulting in sticky spool operation.

NOTE: Put grease on all detent component surfaces before assembly.

Figure 20-40-54

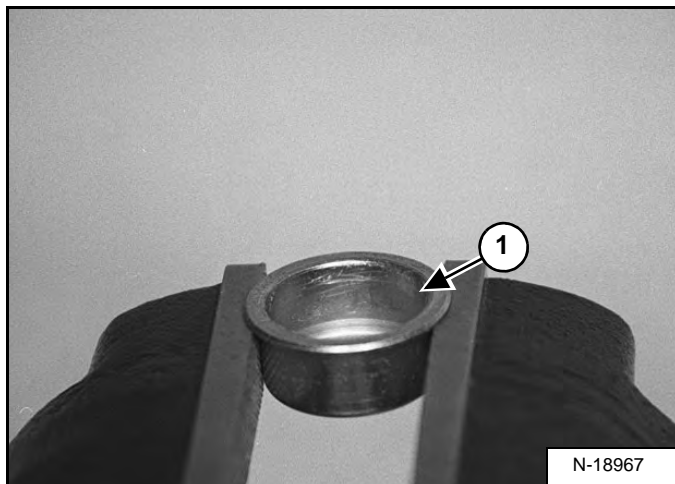

Install the collar (Item 1) [Figure 20-40-54] in a vise. DO NOT overtighten the vise.

Figure 20-40-55

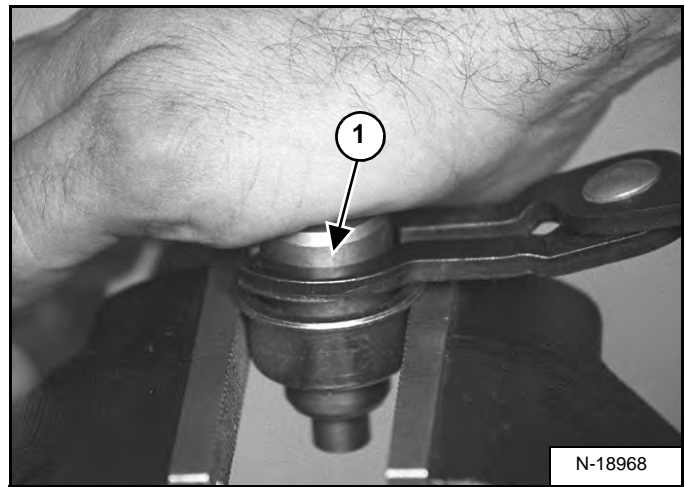

Install the detent balls and spring into the detent adapter (Item 1). Hold the detent balls in position with the tool and install the detent adapter into the end cap [Figure 20-40-55].

Figure 20-40-56

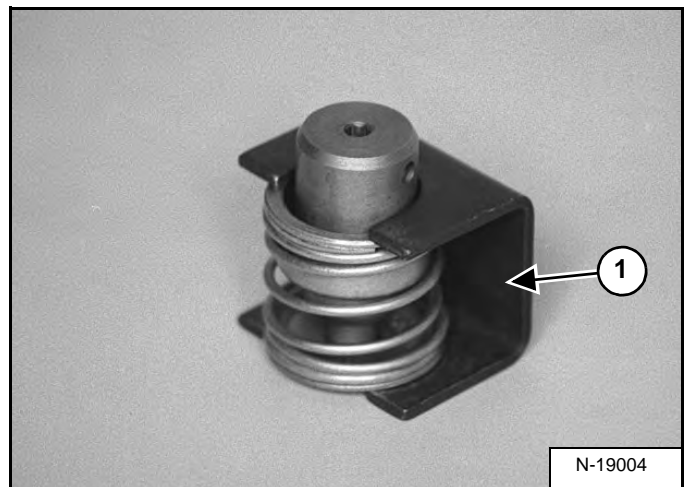

Install the MEL1285 Compression Spring Tool (Item 1) [Figure 20-40-56] over the washer, spring, collar, and detent adapter.

NOTE: Be careful when installing the assembly in the spring tool, the assembly is under spring pressure.

HYDRAULIC CONTROL VALVE (CONT'D)

Lift Spool And Detent Assembly (Cont'd)

Figure 20-40-57

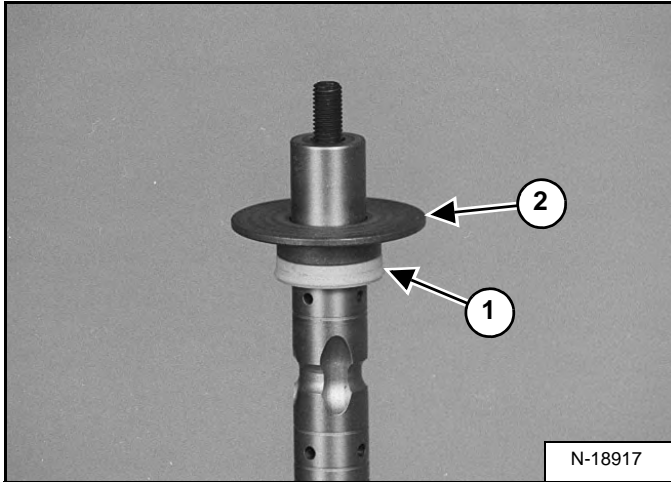

Install the spool seal (Item 1) and back-up washer (Item 2) [Figure 20-40-57] on the spool.

NOTE: The larger diameter of the seal surface must be installed toward the inside of the control valve.

Figure 20-40-58

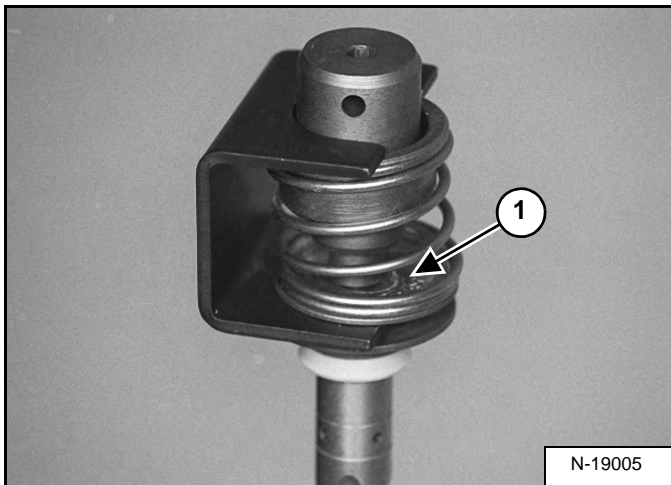

Install the spring assembly on the lift spool hand tight [Figure 20-40-58].

Remove the spring tool. Check the alignment of the detent adapter and the washer.

NOTE: The adapter must fit in the center of the washer (Item 1) [Figure 20-40-58].

Tighten the detent adapter to 10,2 - 11,3 N•m (90 - 100 in-lb) torque.

Figure 20-40-59

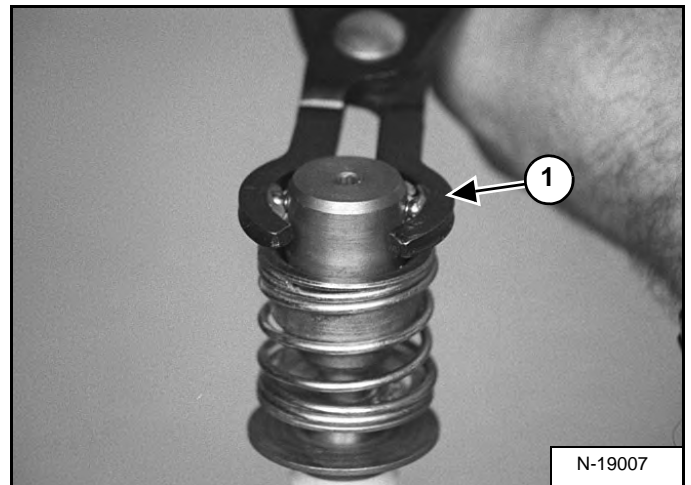

Install the detent balls and spring in the adapter. Hold the detent balls in place with the detent pliers (Item 1) [Figure 20-40-59].

Figure 20-40-60

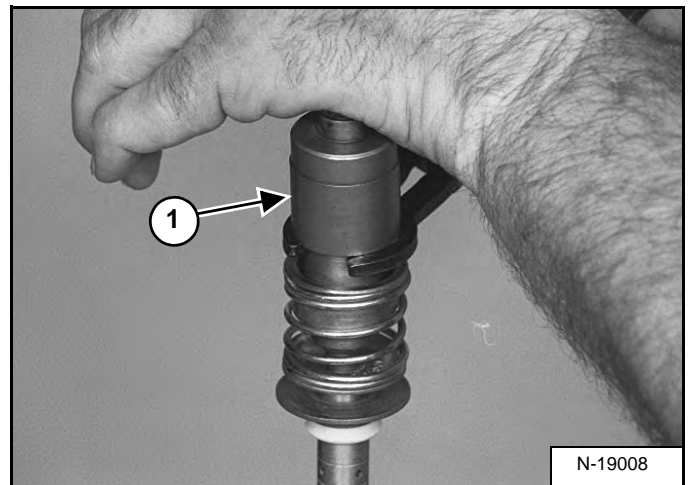

Install the detent sleeve (Item 1) [Figure 20-40-60] on the detent adapter.

While holding the detent balls in position with the tool, push the detent adapter into the end cap [Figure 20-40-60].

HYDRAULIC CONTROL VALVE (CONT'D)

Tilt Spool Removal And Installation

Figure 20-40-61

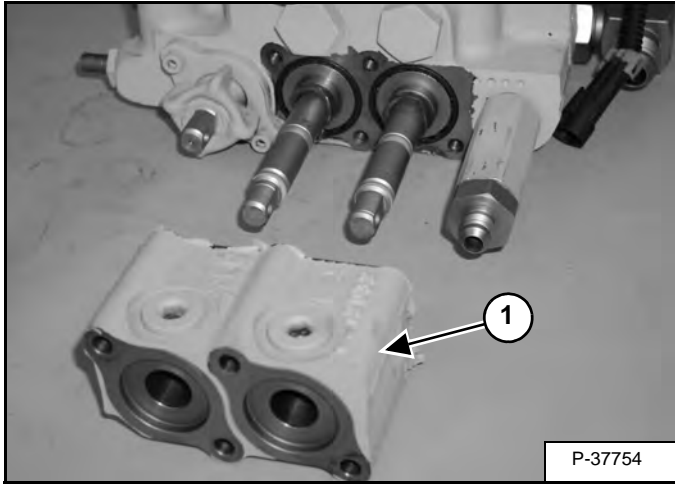

Remove the lift and tilt lock block (Item 1) [Figure 20-40-61] from the control valve. (See Lift And Tilt Lock Block Removal And Installation on Page 20-40-15.)

Figure 20-40-62

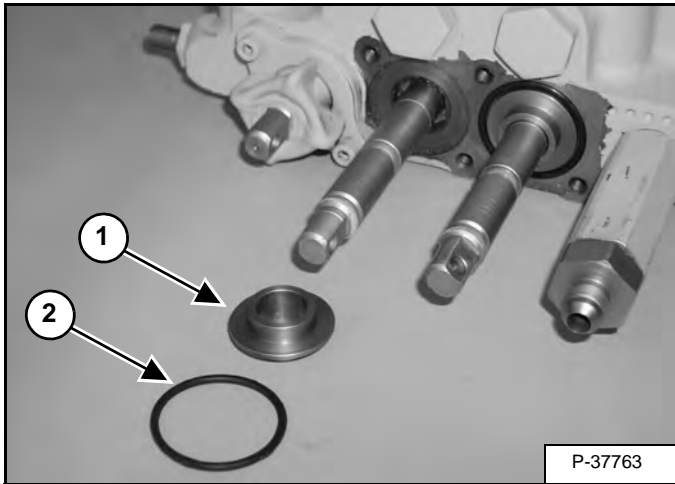

Remove the bushing (Item 1) and O-ring (Item 2) [Figure 20-40-62] from the tilt spool linkage end.

Figure 20-40-63

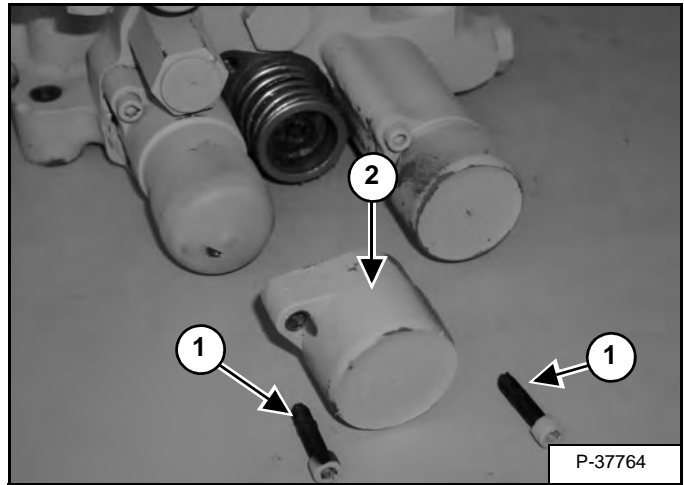

Remove the end cap mounting screws (Item 1) and remove the end cap (Item 2) [Figure 20-40-63] from the tilt spool centering spring.

Assembly: Tighten the mounting screws to 10,2 - 11,3 N•m (90 - 100 in-lb) torque.

Figure 20-40-64

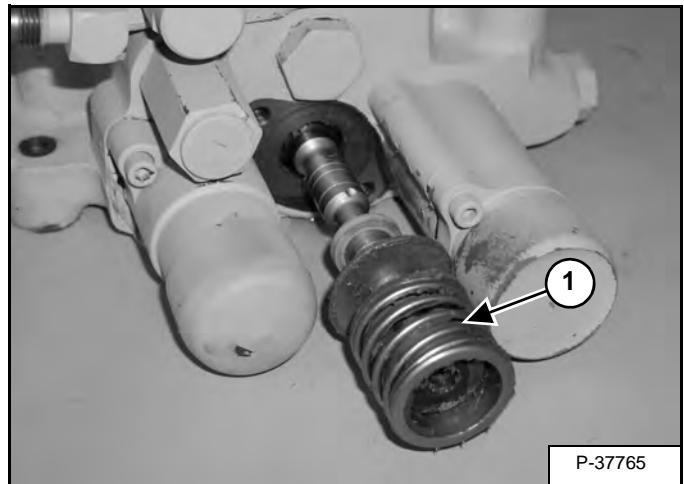

Remove the spool and centering spring assembly from the control valve (Item 1) [Figure 20-40-64].

HYDRAULIC CONTROL VALVE (CONT'D)

Tilt Spool Disassembly And Assembly

Figure 20-40-65

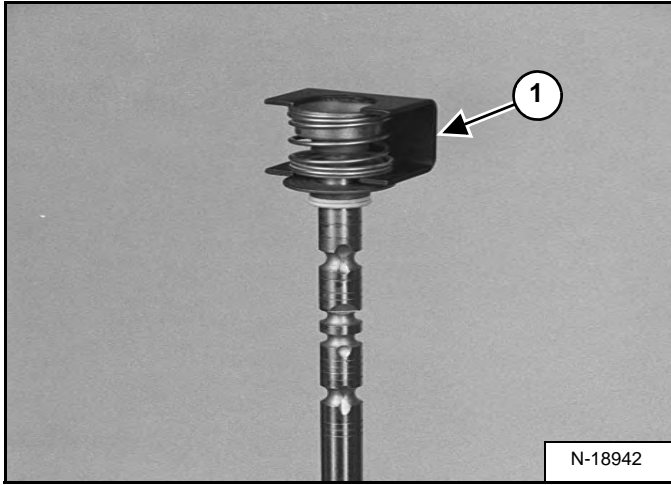

Put the linkage end of the spool in a vise and install the MEL1285 Compression Spring Tool (Item 1) [Figure 20-40-65]

Figure 20-40-66

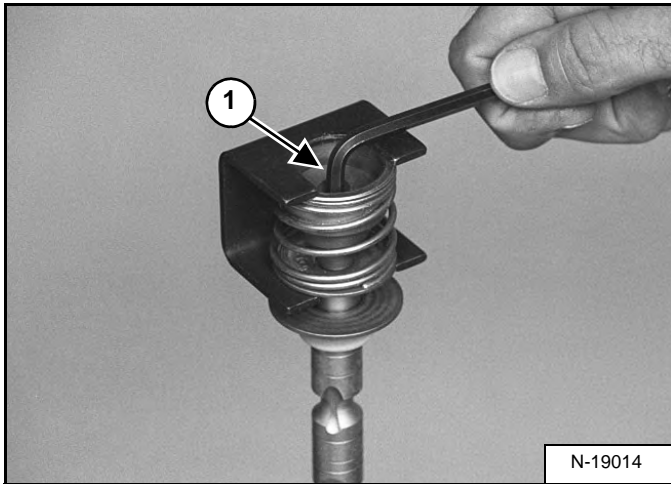

Remove the bolt (Item 1) [Figure 20-40-66] holding the centering spring to the spool.

Installation: Tighten the bolt to 10,2 - 11,3 N•m (90 - 100 in-lb) torque.

Remove the spring tool from the centering spring assembly. Remove the back-up washer and spool seal.

Figure 20-40-67

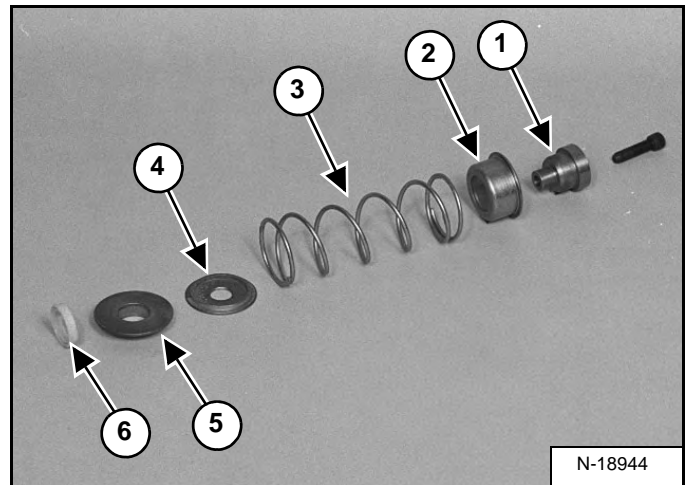

Inspect the adapter (Item 1), collar (Item 2), spring (Item 3), washer (Item 4), bushing (Item 5), and spool seal (Item 6) [Figure 20-40-67].

Figure 20-40-68

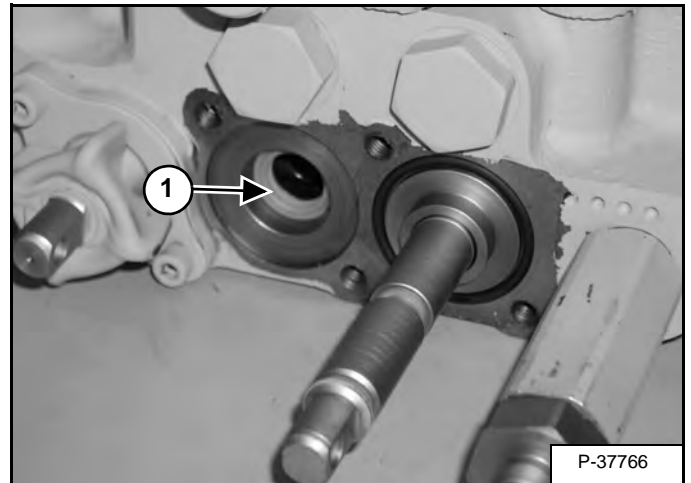

Remove the spool seal (Item 1) [Figure 20-40-68] from the linkage end of the control valve.

Assembly: Always use a new spool seal.

HYDRAULIC CONTROL VALVE (CONT'D)

Auxiliary Spool Removal And Installation

Figure 20-40-69

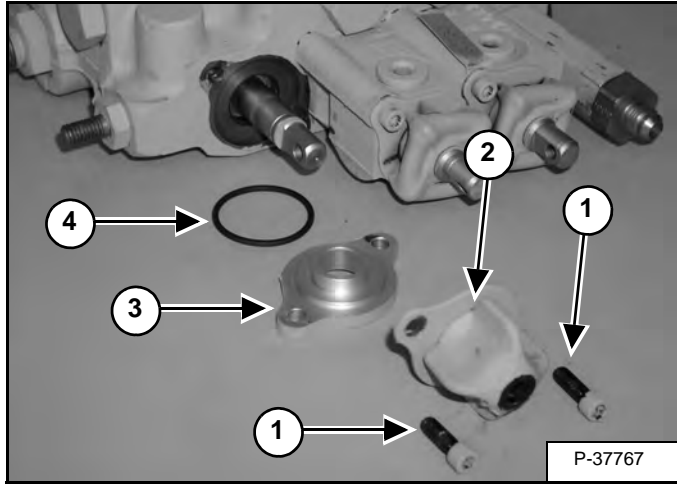

Remove the screws (Item 1) and rubber boot (Item 2) [Figure 20-40-69] from the linkage end of the control valve.

Remove the spool seal retainer (Item 3), and O-ring (Item 4) [Figure 20-40-69] from the control valve.

Assembly: Tighten the screws to 10,2 - 11,3 N•m (90 - 100 in-lb) torque.

Figure 20-40-70

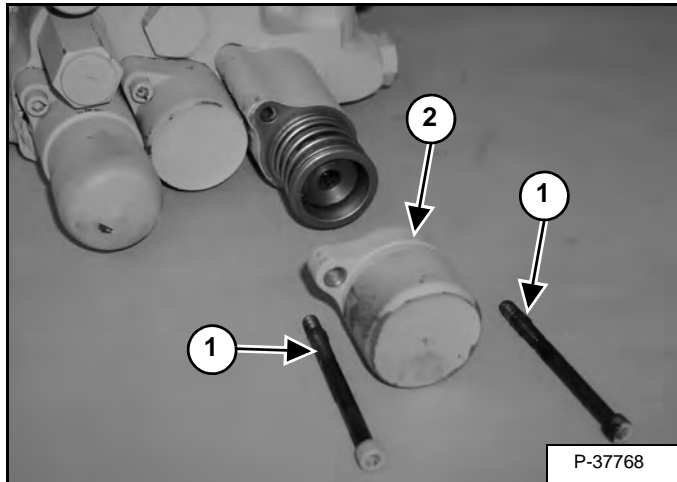

Remove the two mounting screws (Item 1) and detent cap (Item 2) [Figure 20-40-70].

Figure 20-40-71

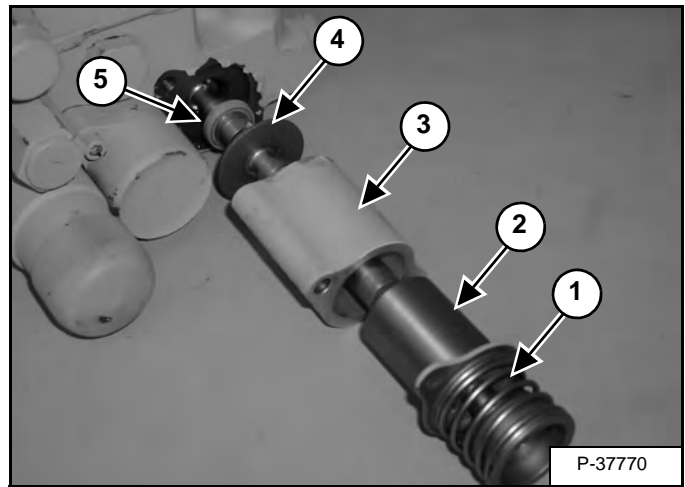

Remove the centering spring assembly (Item 1), detent retainer (Item 2), housing (Item 3), seal retainer (Item 4), and spool seal (Item 5) [Figure 20-40-71].

HYDRAULIC CONTROL VALVE (CONT'D)

Auxiliary Spool Disassembly And Assembly

Figure 20-40-72

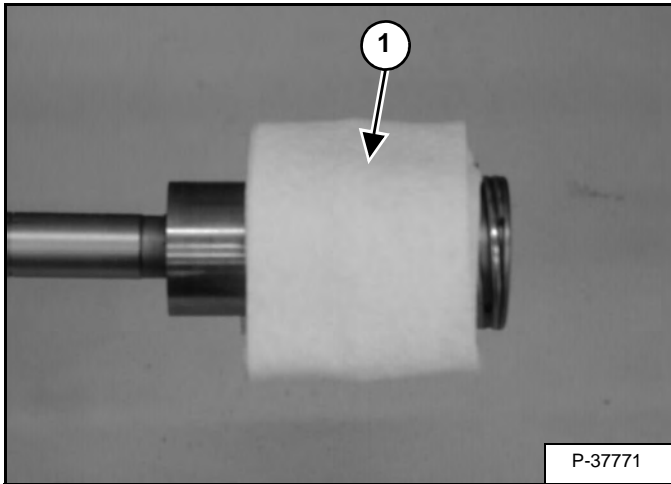

Wrap a rag (Item 1) [Figure 20-40-72] around the detent ball retainer and the centering spring. Slowly remove the retainer from the balls.

Figure 20-40-73

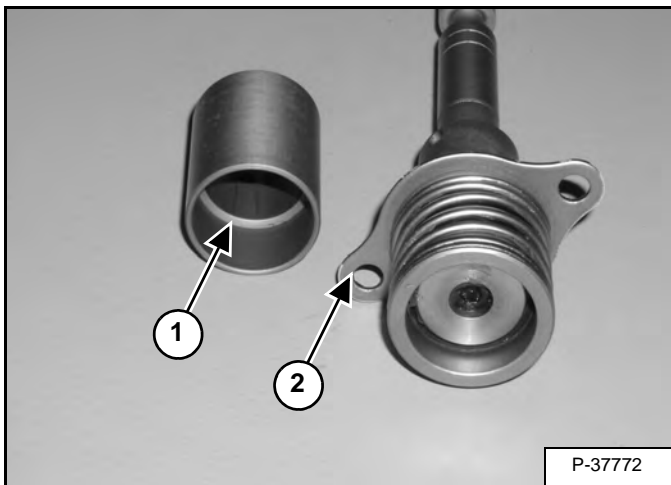

The detent retainer must be installed over the spool detent balls in the position shown [Figure 20-40-73].

The deeper counter bore end of the retainer (Item 1) goes on the spool first and will rest against the centering spring plate (Item 2) [Figure 20-40-73].

Figure 20-40-74

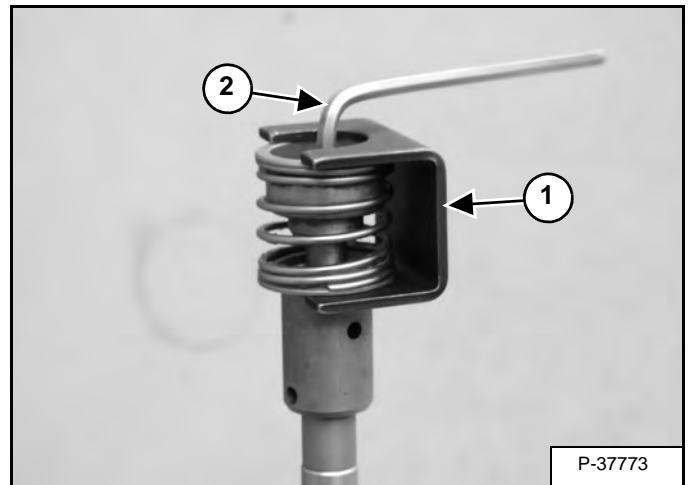

Assembly: Put the linkage end of the spool in a vise and install the MEL1285 Compression Spring Tool (Item 1) [Figure 20-40-74].

Use an Allen wrench (Item 2) [Figure 20-40-74] to remove the bolt holding the centering spring assembly on the spool.

Installation: Tighten the bolt to 10,2 - 11,3 N•m (90 - 100 in-lb) torque.

Remove the assembly from the spool.

Figure 20-40-75

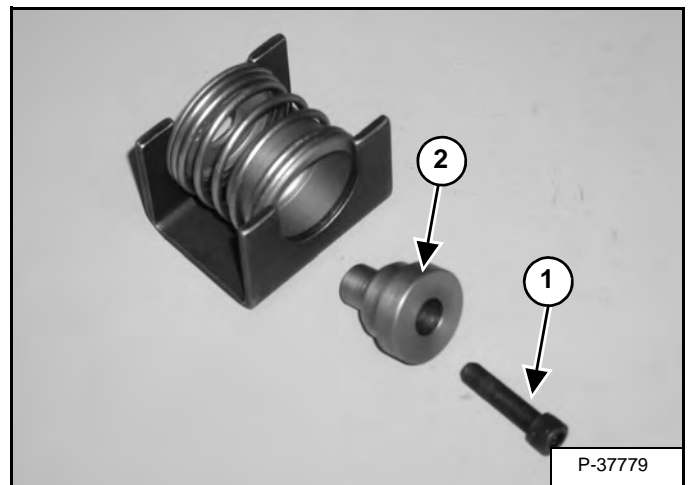

Remove the bolt (Item 1) and adapter (Item 2) [Figure 20-40-75] from the centering spring assembly. Inspect the condition of the bolt and adapter.

HYDRAULIC CONTROL VALVE (CONT'D)

Auxiliary Spool Disassembly And Assembly (Cont'd)

Figure 20-40-76

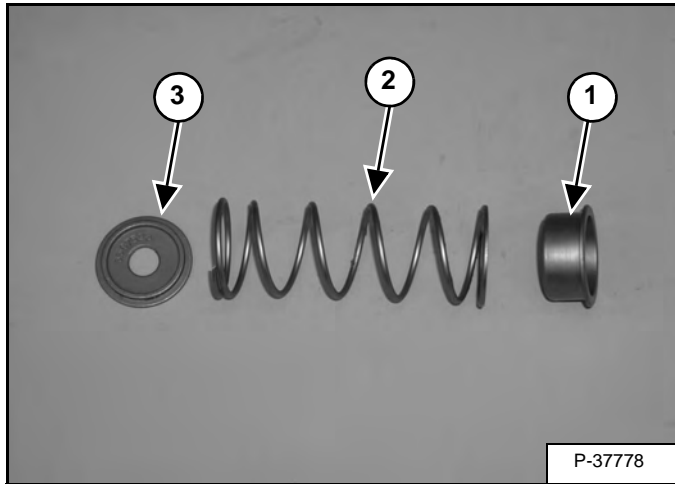

NOTE: Be careful when removing the assembly from the spring tool, the assembly is under spring pressure.

Inspect the condition of the collar (Item 1), spring (Item 2), and washer (Item 3) [Figure 20-40-76].

Figure 20-40-77

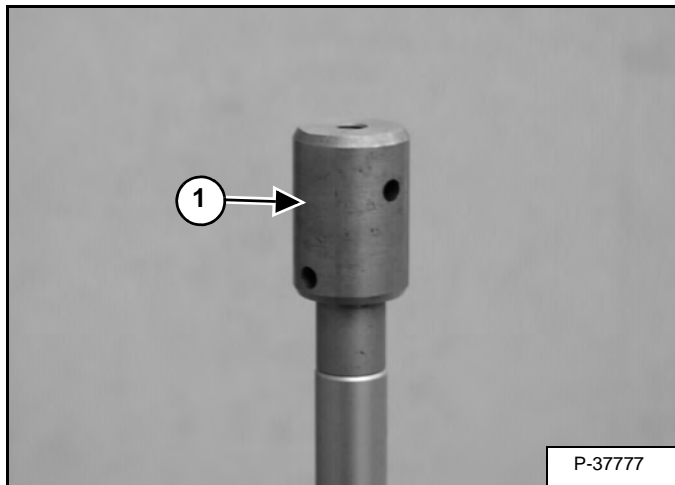

Remove the detent adapter (Item 1) [Figure 20-40-77].

Installation: Tighten the adapter to 10,2 - 11,3 N•m (90 - 100 in-lb) torque.

Figure 20-40-78

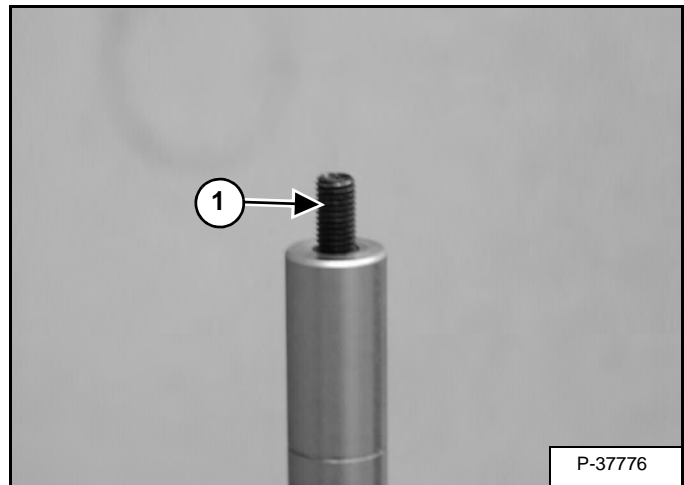

Remove the stud (Item 1) [Figure 20-40-78] from the end of the spool.

Installation: The stud will bottom in the spool during assembly.

Figure 20-40-79

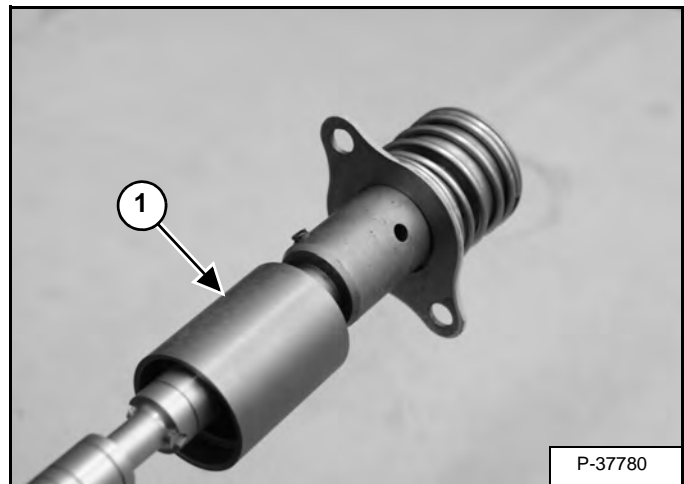

Assembly: Install the detent retainer (Item 1) [Figure 20-40-79] on the spool

HYDRAULIC CONTROL VALVE (CONT'D)

Auxiliary Spool Disassembly And Assembly (Cont'd)

Figure 20-40-80

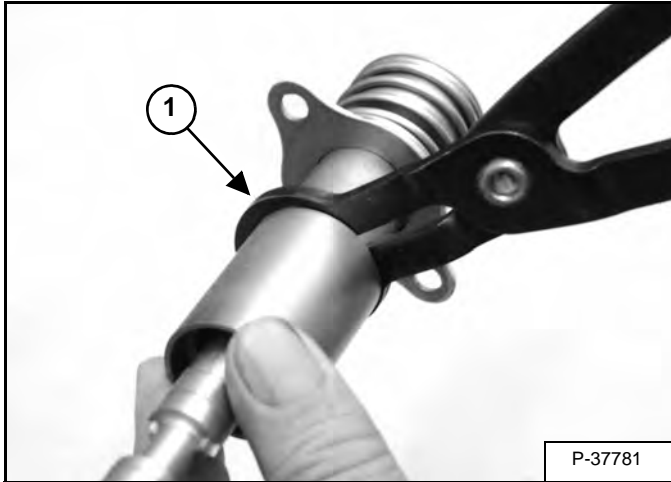

Assembly: Install the first set of detent balls and spring in the adapter. Hold the detent balls in place with the detent pliers (Item 1) [Figure 20-40-80] while installing the detent retainer.

Figure 20-40-81

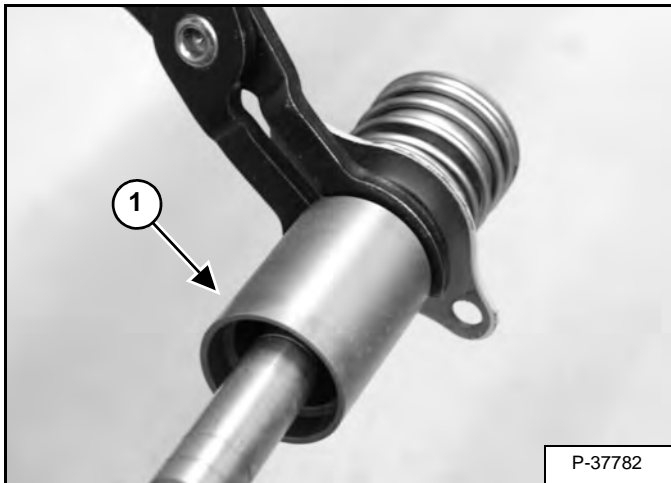

Assembly: Install the second set of detent balls and spring in the adapter. Hold the detent balls in place with the detent pliers (Item 1) [Figure 20-40-81] while installing the detent retainer.

Figure 20-40-82

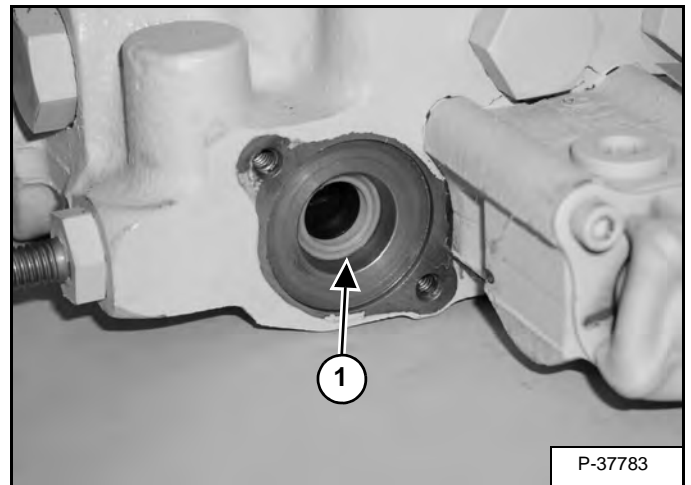

Remove the spool seal (Item 1) [Figure 20-40-82].

HYDRAULIC CONTROL VALVE (CONT'D)

Spool Seal Installation

To install new spool seals when the centering spring (tilt spool) or other detent assembly (lift spool) are not removed from the spool, use the following procedure:

Inspect the seal surface area (in the control valve) for rust, corrosion, scratches, etc. Correct any irregularities before continuing.

Install the back-up washer on the spool.

Figure 20-40-83

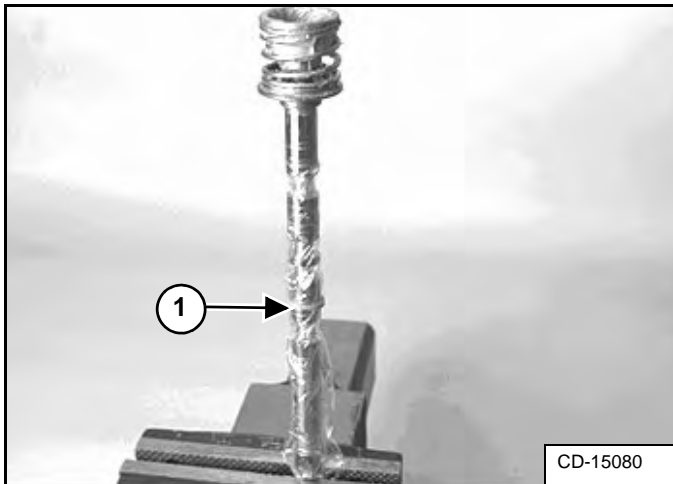

Put plastic material on the valve spool **[Figure 20-40-83]**.

Put clean oil on the spool seal. Install the spool seal (Item 1) **[Figure 20-40-83]** on the spool being careful not to damage the seal on the sharp edges.

Remove the plastic material and install the spool into the control valve.

HYDRAULIC CONTROL VALVE (CONT'D)

Auxiliary Pivot Bracket Removal And Installation

Figure 20-40-84

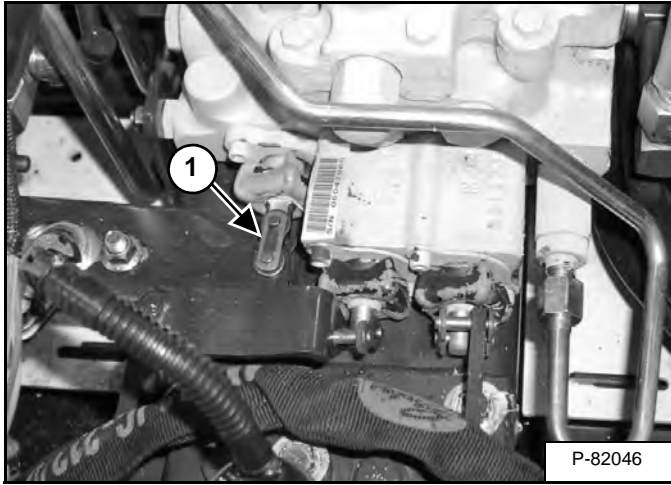

Remove the hair pin (Item 1) [Figure 20-40-84] and the link from the auxiliary spool on the control valve.

Figure 20-40-85

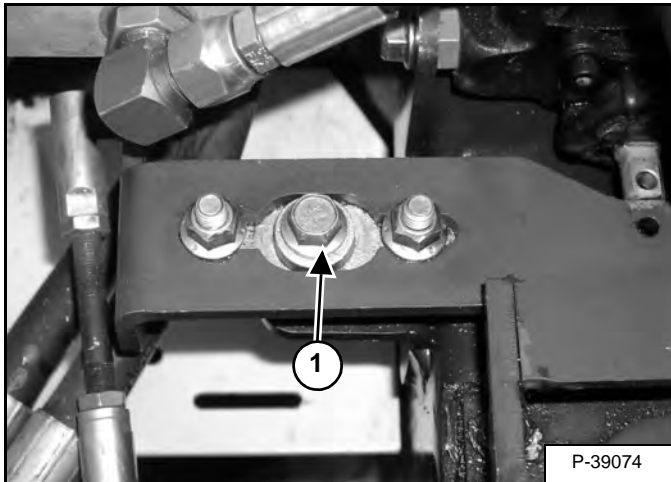

Remove the bolt (Item 1) [Figure 20-40-85] to remove the bracket assembly.

Installation: Tighten the bolt to 34 - 38 N•m (25 - 28 ft-lb) torque.

Auxiliary Pivot Bracket Disassembly And Assembly

Figure 20-40-86

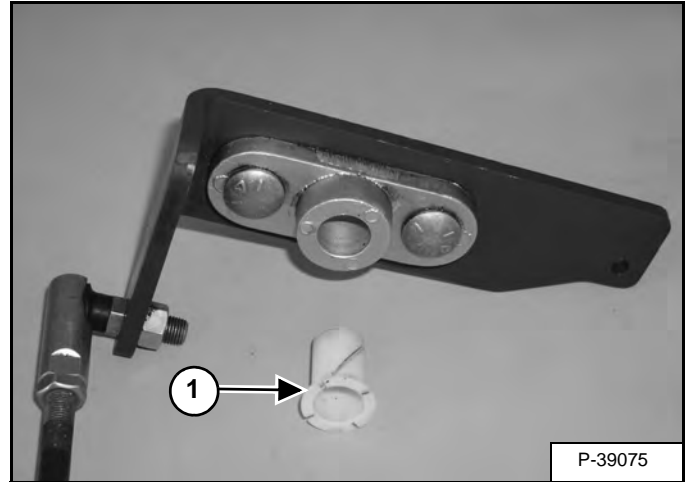

Assembly: The plastic bushing (Item 1) [Figure 20-40-86] is inserted from the bottom of the flange as shown.

Figure 20-40-87

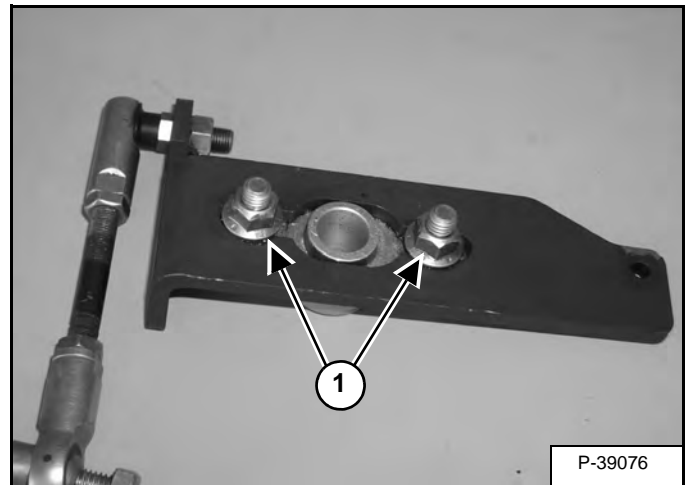

Remove the two nuts (Item 1) [Figure 20-40-87] to remove the flange from the bracket.

Assembly: Tighten the nuts to 34 - 38 N•m (25 - 28 ft-lb) torque.



Bobcat®

LIFT ARM BYPASS CONTROL VALVE

Description

The lift arm bypass control valve is located in front of the operator's seat.

The lift arm bypass control valve is manually operated by turning the knob (Item 1) **[Figure 20-50-1]** 90° clockwise and pulling on the control knob. The valve releases the hydraulic fluid from the base end of the lift cylinder(s) which allows the lift arm to slowly lower to the transport position.

Testing

Figure 20-50-1

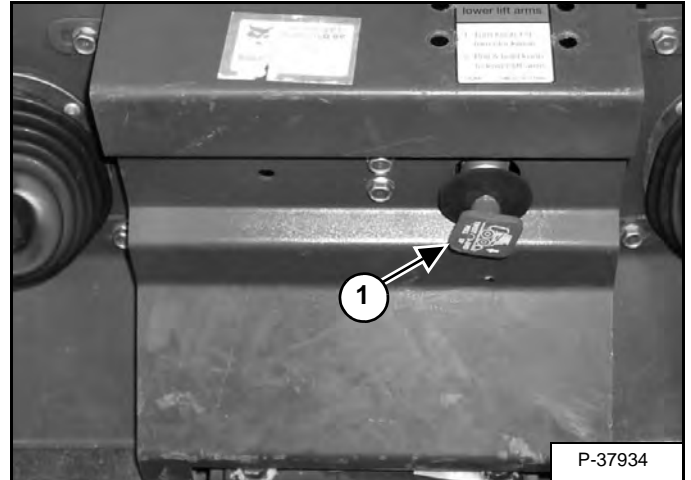

Raise the lift arms 2 m (6 ft) off the ground. Stop the engine. Turn the Lift Arm Bypass Control Knob (Item 1) **[Figure 20-50-1]** 90° clockwise. Then pull out and hold the Lift Arm Bypass Control Knob until the lift arms slowly lower.

The knob should return to its initial position.

LIFT ARM BYPASS CONTROL VALVE (CONT'D)

Removal And Installation

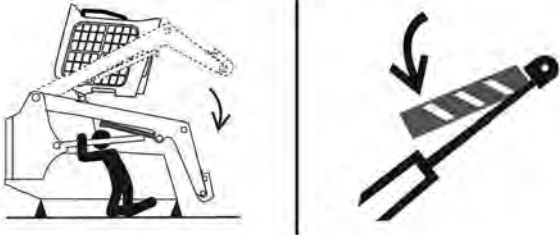

P-90328

AVOID DEATH

- Disconnecting or loosening any hydraulic tubeline, hose, fitting, component or a part failure can cause lift arms to drop.
- Keep out of this area when lift arms are raised unless supported by an approved lift arm support. Replace if damaged.

D-1009-0409



Never work on a machine with the lift arms up unless the lift arms are secured by an approved lift arm support device. Failure to use an approved lift arm support device can allow the lift arms or attachment to fall and cause injury or death.

W-2059-0598

Install jackstands under the rear corners of the loader.

Raise the operator cab. (See Raising on Page 10-30-2.)

Figure 20-50-2

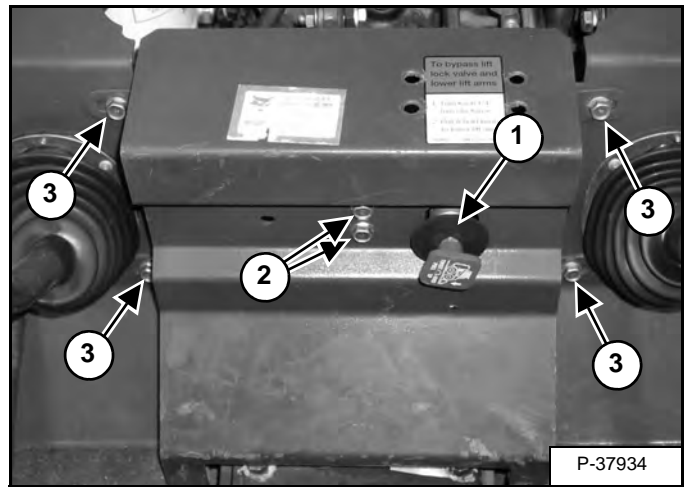

Remove the knob and washer (Item 1) [Figure 20-50-2].

Remove the two mounting bolts (Item 2) [Figure 20-50-2] securing the valve body to the control shield.

Remove the control shield mounting bolts (Item 3) [Figure 20-50-2].

Figure 20-50-3

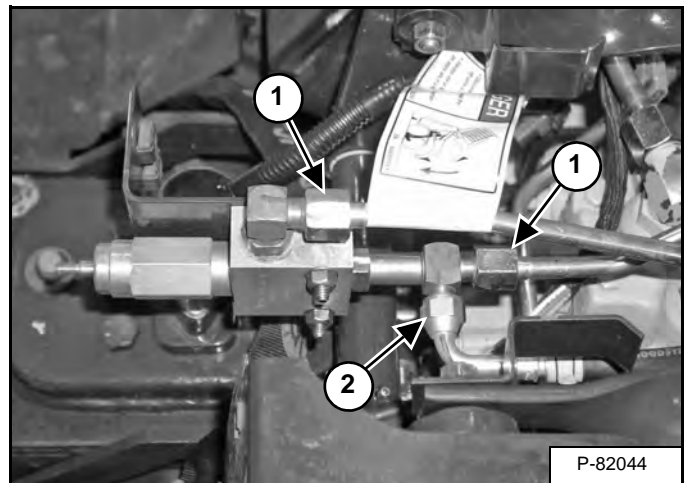

Remove the tubelines (Item 1) and hose (Item 2) [Figure 20-50-3] to remove the bypass body assembly.

Install plugs on the tubelines.

LIFT ARM BYPASS CONTROL VALVE (CONT'D)

Disassembly And Assembly

Figure 20-50-4

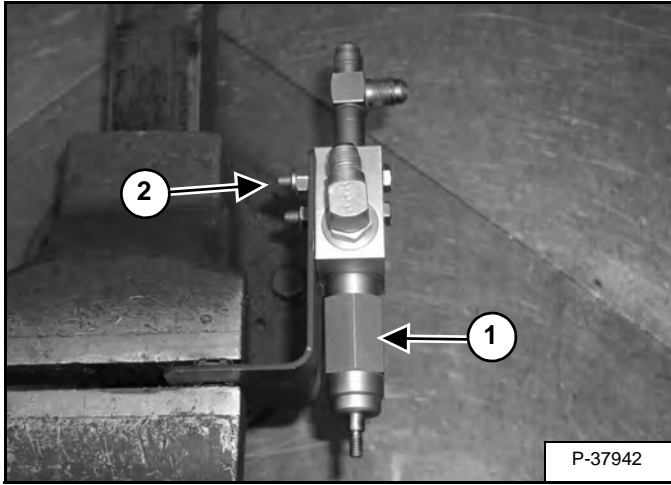

Install the valve body in a vise and remove the valve (Item 1) [Figure 20-50-4]

The valve body can be removed from the mounting bracket by removing the two mounting nuts (Item 2) [Figure 20-50-4] and bolts.

Figure 20-50-5

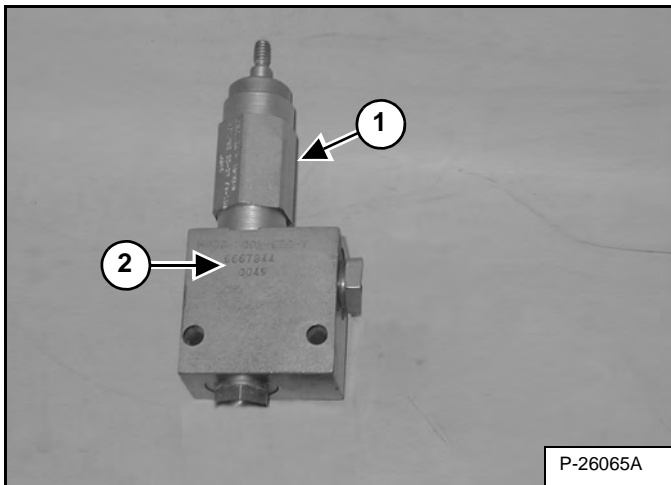

Remove the bypass valve (Item 1) from the valve block (Item 2) [Figure 20-50-5]. Inspect the bypass valve for damage and replace if necessary.

Installation: Tighten the valve to 45 - 50 N•m (33 - 37 ft-lb) torque.

Inspect the hydraulic fittings on the valve block for damage and replace if necessary.



Bobcat®

HYDRAULIC PUMP

Description

The hydraulic gear pump is attached to the end of the hydrostatic pumps and is located on the left side of the loader. The hydraulic gear pump is a combination of gear pumps that provide hydraulic flow to several hydraulic systems.

A seal kit is available to service the hydraulic pump. If any of the main components of the pump are damaged, the entire pump must be replaced.

Direct Pump Testing

The tools listed will be needed to do the following procedure:

MEL1563 or 7217666 - Remote Start Tool Kit

MEL10003 - Hydraulic Tester

MEL10006 - Hydraulic Test Kit

NOTE: The relief pressure must be per specification before the output test is performed.

WARNING

Put jackstands under the front axles and rear corners of the frame before running the engine for service. Failure to use jackstands can allow the machine to fall or move and cause injury or death.

W-2017-0286

Figure 20-60-1

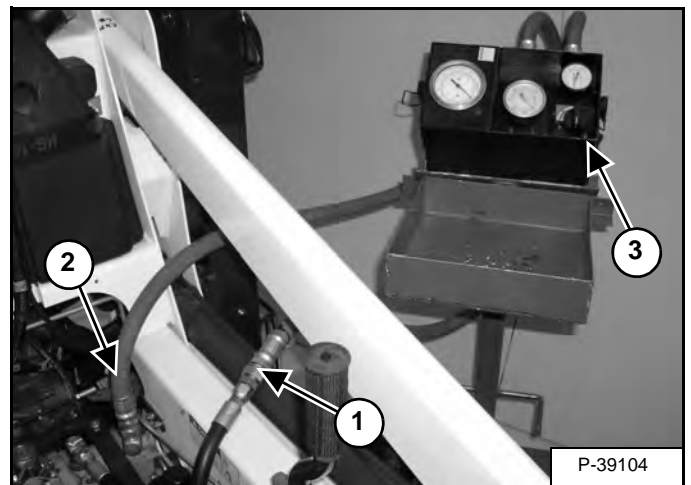

Lift and block the loader. (See Procedure on Page 10-10-1.)

Disconnect the OUTLET hose (Item 1) [Figure 20-60-1] from the hydraulic pump. Connect the OUTLET hose from the tester to the hose (Item 1) [Figure 20-60-1].

Connect the INLET hose (Item 2) [Figure 20-60-1] from the tester to the OUTLET fitting on the hydraulic pump.

Open the restrictor control (Item 3) [Figure 20-60-1] fully (counterclockwise) before testing the relief valve.

HYDRAULIC PUMP (CONT'D)

Direct Pump Testing (Cont'd)

IMPORTANT

The hydraulic tester must be in the fully open position before you start the engine.

I-2024-0284

Figure 20-60-2

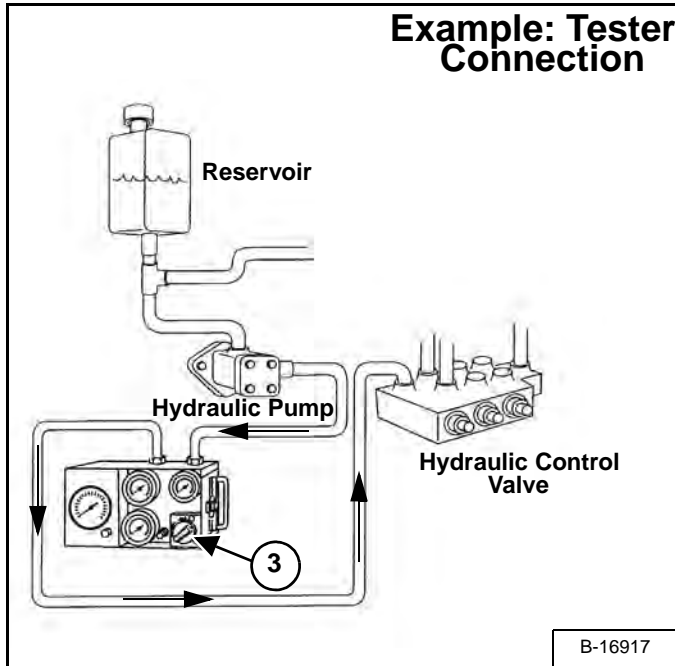

A sample tester connection is shown in picture **[Figure 20-60-2]**.

Start the engine and run at low rpm. Make sure the tester is connected correctly. If no flow is indicated on the tester, the hoses are connected wrong. With the hoses connected correctly, increase the engine speed to full rpm*.

Warm the hydraulic fluid to 60°C (140°F) by turning the restrictor control (Item 3) **[Figure 20-60-1]** and **[Figure 20-60-2]** on the tester to about 6895 kPa (69 bar) (1000 psi). DO NOT exceed system relief pressure. Open the restrictor control and record the free flow (L/min [U.S. gpm]) at full rpm.

Remove the auxiliary hydraulics lock bolt and push the right steering lever all the way to the right (detent) (See MAIN RELIEF VALVE on Page 20-30-1.) to engage the auxiliary hydraulics (attachment must be disconnected from the front auxiliary couplers). The fluid pressure will go over main relief. If the pressure is not to specifications, first adjust the main relief valve. (See MAIN RELIEF VALVE on Page 20-30-1.) Record the highest pressure (psi) and flow (L/min [U.S. gpm]). The high pressure flow must be at least 80% of free flow.

$$\% = \frac{\text{HIGH PRESSURE FLOW (U.S. gpm)}}{\text{FREE FLOW (U.S. gpm)}} \times 100$$

A low percentage indicates a failed pump.

* Refer to *SPECIFICATIONS* Section for system relief pressure, rpm, and hydraulic pump capacity (L/min [U.S. gpm]).

HYDRAULIC PUMP (CONT'D)

Removal And Installation

IMPORTANT

When repairing hydrostatic and hydraulic systems, clean the work area before disassembly and keep all parts clean. Always use caps and plugs on hoses, tubelines and ports to keep dirt out. Dirt can quickly damage the system.

I-2003-0888

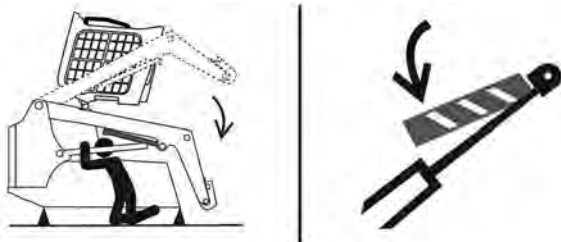

P-90328

AVOID DEATH

- Disconnecting or loosening any hydraulic tubeline, hose, fitting, component or a part failure can cause lift arms to drop.
- Keep out of this area when lift arms are raised unless supported by an approved lift arm support. Replace if damaged.

D-1009-0409

! WARNING

Never work on a machine with the lift arms up unless the lift arms are secured by an approved lift arm support device. Failure to use an approved lift arm support device can allow the lift arms or attachment to fall and cause injury or death.

W-2059-0598

Raise the lift arms and install the lift arm support device. (See Installing on Page 10-20-1.)

Stop the engine and raise the seat bar.

Lift and block the loader. (See Procedure on Page 10-10-1.) Raise the operator cab. (See Raising on Page 10-30-2.)

NOTE: The engine and hydrostatic pump assembly must be moved to the right to remove the hydraulic pump.

Figure 20-60-3

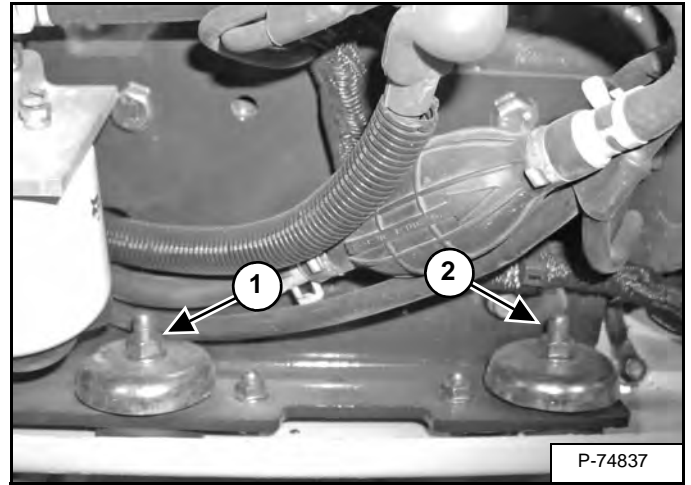

Loosen the left engine mounting bolt (Item 1), and remove the right engine mounting bolt (Item 2) [Figure 20-60-3].

Figure 20-60-4

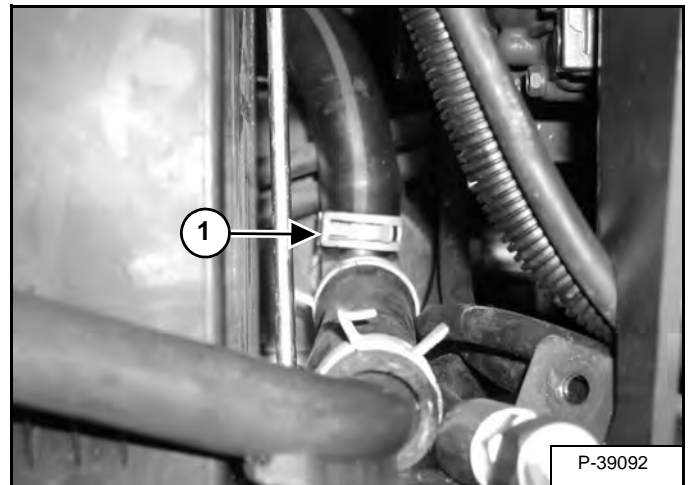

Loosen the clamp (Item 1) [Figure 20-60-4] to remove the suction hose from the hydraulic oil reservoir fill tube.

NOTE: Removing the battery will make gear pump removal and installation easier. (See Removal And Installation on Page 60-20-1.)

HYDRAULIC PUMP (CONT'D)

Removal And Installation (Cont'd)

Figure 20-60-5

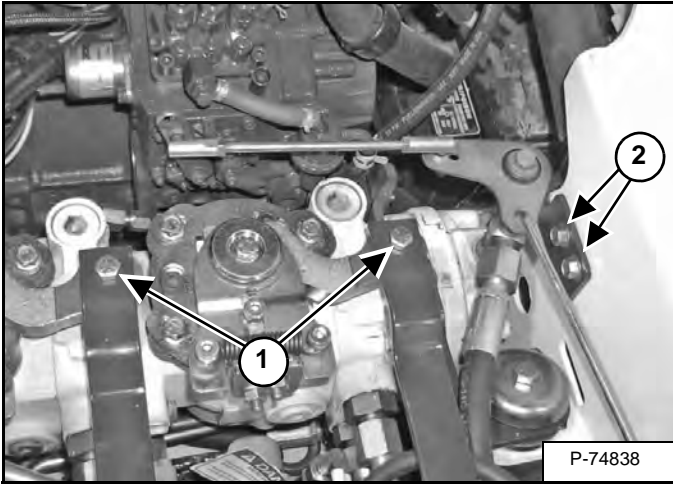

Remove the bolts (Item 1) [Figure 20-60-5] from the steering lever linkage. Remove the linkage from the hydrostatic pumps.

Remove the two bolts and nuts (Item 2) [Figure 20-60-5] from the pivot mounting bracket.

Remove the speed control linkage from the pivot.

Figure 20-60-6

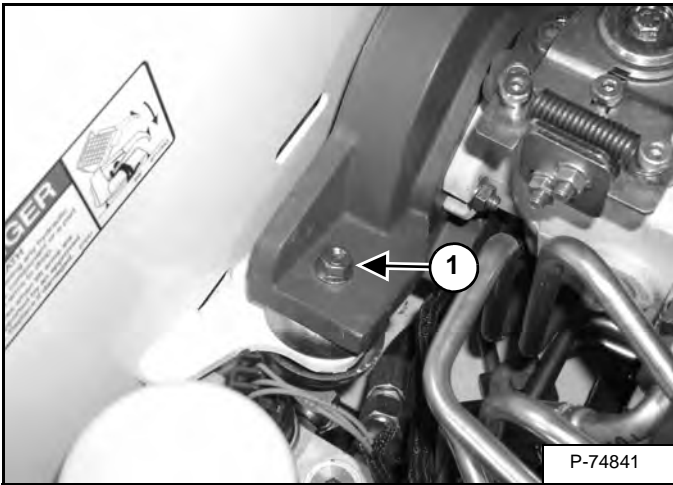

Remove the nut, bolt, spacer, mounts and snubber cups (Item 1) [Figure 20-60-6] from the right side hydrostatic pump mount.

Figure 20-60-7

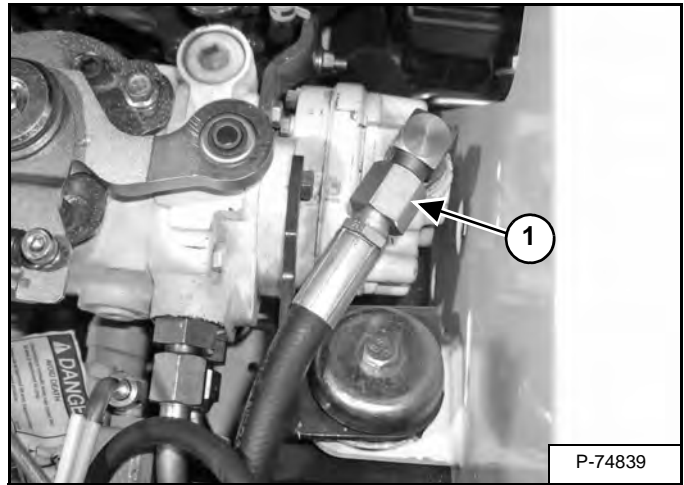

Disconnect the outlet hose (Item 1) [Figure 20-60-7] from the hydraulic pump.

Figure 20-60-8

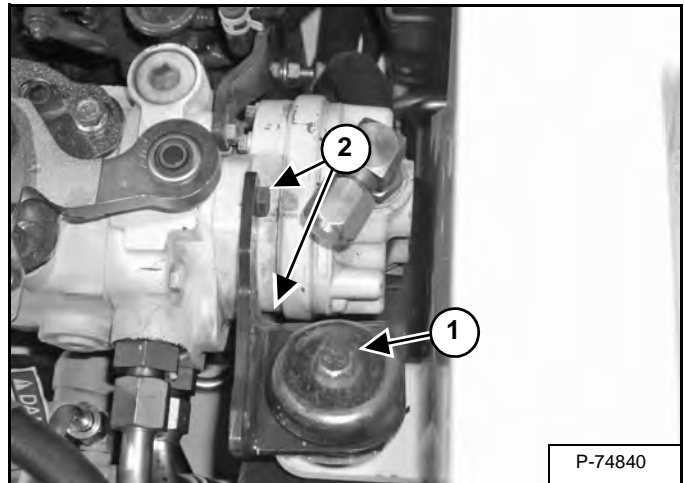

Remove the nut, bolt, spacer, mounts and snubber cups (Item 1) [Figure 20-60-8] from the right side hydrostatic pump mount.

Remove the two hydraulic pump mounting bolts (Item 2) [Figure 20-60-8] (top and bottom).

Installation: Tighten the hydraulic pump mounting bolts to 37 - 50 N•m (27 - 37 ft-lb) torque.

Remove the hydraulic pump.

HYDRAULIC PUMP (CONT'D)

Removal And Installation (Cont'd)

Figure 20-60-9

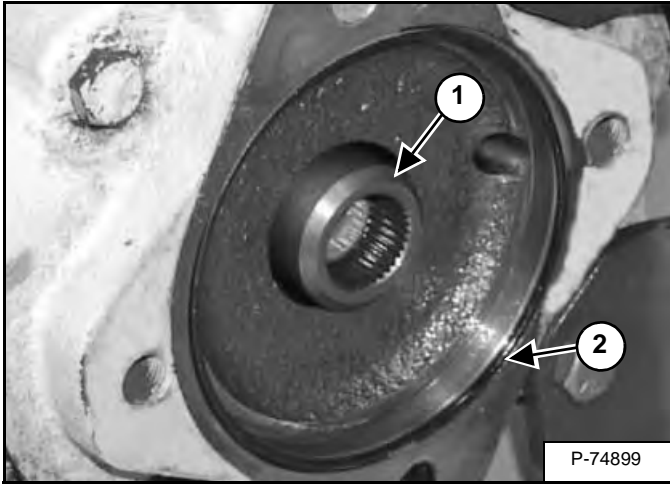

Remove the coupler (Item 1) [Figure 20-60-9] from the hydrostatic pump mount and check for damage. Replace as needed.

Remove the O-ring (Item 2) [Figure 20-60-9] from the hydrostatic pump and replace with a new one.

Installation: Make sure the new O-ring is installed onto the gear pump when assembling.

Hydraulic Pump Startup

Ensure the hydraulic reservoir is filled to the correct level before starting the engine. (See Checking And Adding Fluid on Page 10-120-1.)

HYDRAULIC PUMP (CONT'D)

Parts Identification

1. Bolt
2. Washer
3. Cover
4. O-ring
5. Back-up ring
6. Seal
7. Plate
8. Drive Gear
9. Idler Gear
10. Body

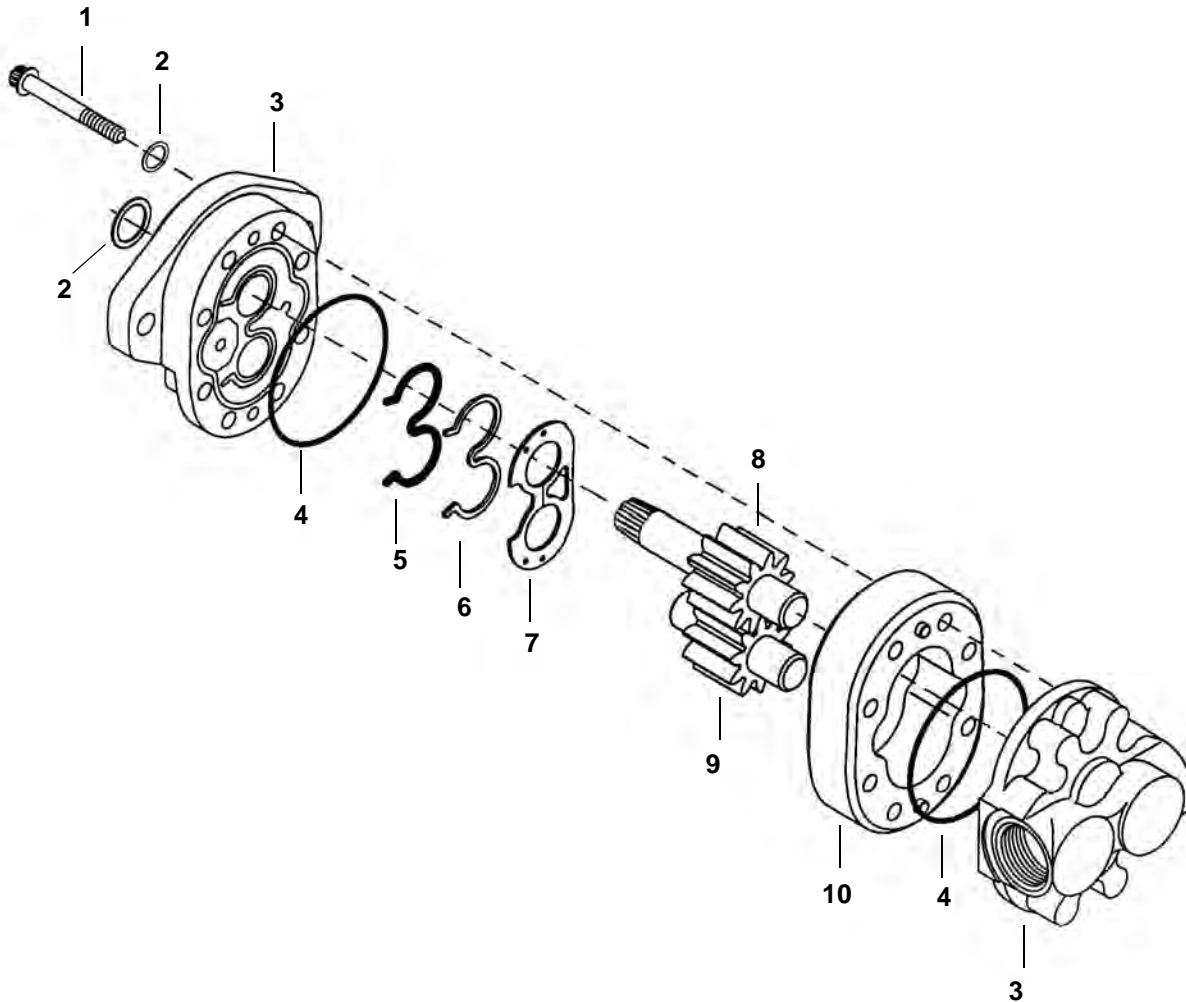

B-13927C

HYDRAULIC PUMP (CONT'D)

Disassembly And Assembly

IMPORTANT

When repairing hydrostatic and hydraulic systems, clean the work area before disassembly and keep all parts clean. Always use caps and plugs on hoses, tubelines and ports to keep dirt out. Dirt can quickly damage the system.

I-2003-0888

Figure 20-60-10

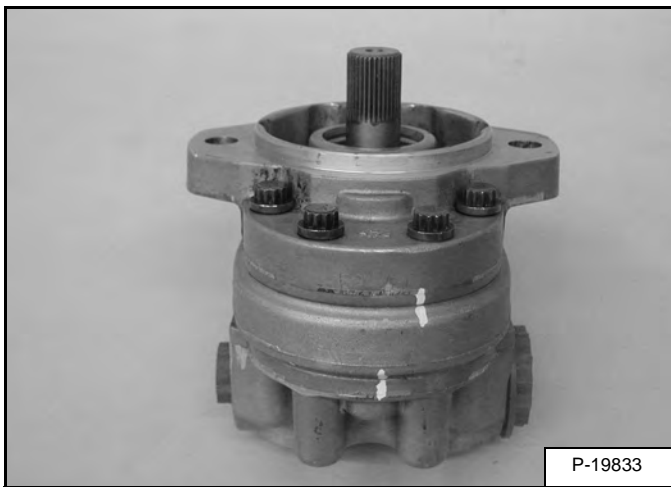

NOTE: Always use new O-rings, gaskets, and seals when assembling the hydraulic pump.

Put the hydraulic pump in the vise.

Put a mark across the housing of the pump for correct assembly [Figure 20-60-10].

NOTE: Only the Seal Kit is available for the hydraulic pump. If any other parts are worn, replace the pump assembly.

Figure 20-60-11

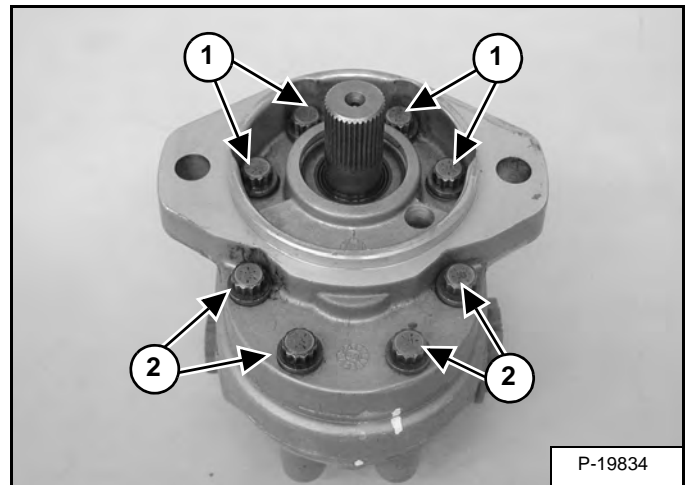

Remove the eight bolts (Item 1 and 2) [Figure 20-60-11] from the pump.

Assembly: Tighten the bolts 33 - 38 N•m (25 - 28 ft-lb) torque.

NOTE: Use new washers under bolts (Item 1) [Figure 20-60-11] during assembly.

Remove the pump from the vise.

Figure 20-60-12

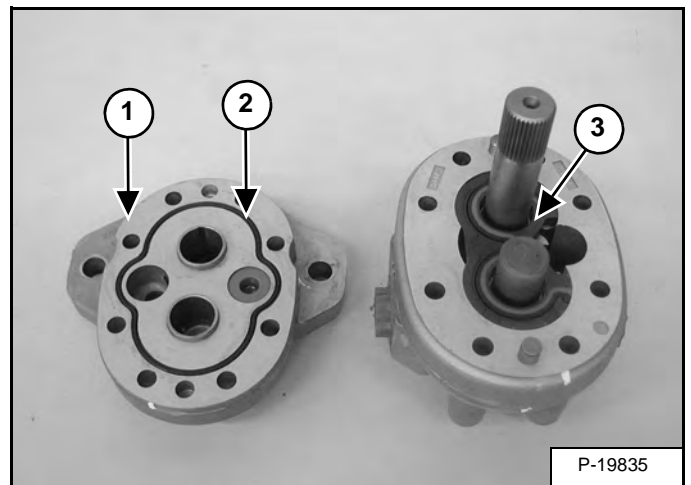

Remove the front cover (Item 1) [Figure 20-60-12] from the pump.

Remove the O-ring (Item 2) [Figure 20-60-12] from the front cover.

Remove the pressure plate (Item 3) [Figure 20-60-12] from the pump.

HYDRAULIC PUMP (CONT'D)

Disassembly And Assembly (Cont'd)

Figure 20-60-13

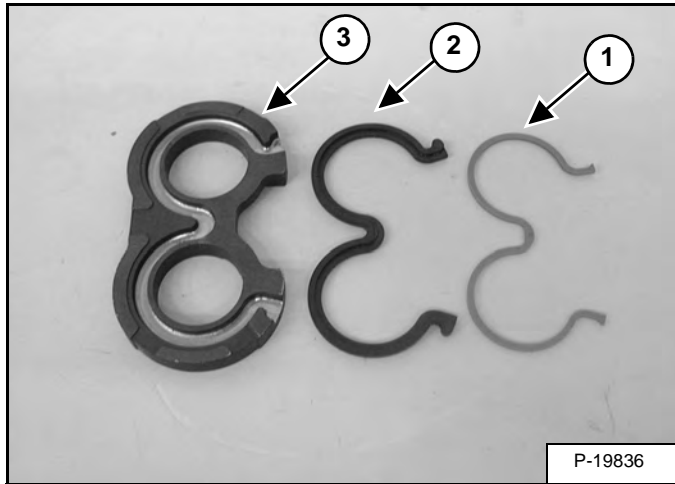

Remove the back-up ring (Item 1) and seal (Item 2) from the pressure plate (Item 3) [Figure 20-60-13].

Inspect the pressure plate for wear.

Figure 20-60-14

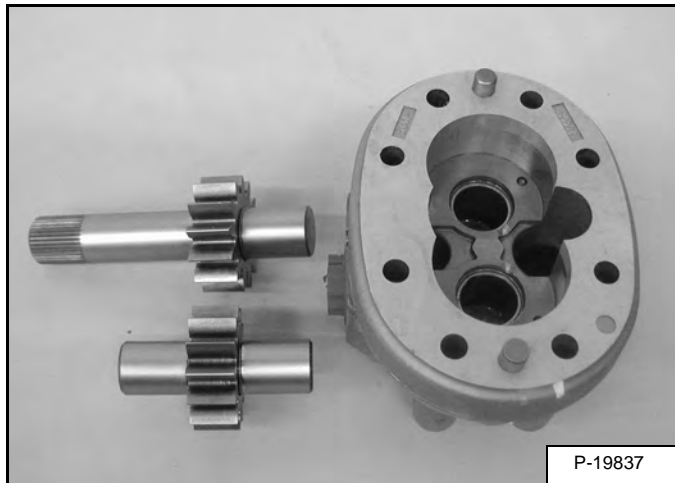

Remove the pump gears [Figure 20-60-14].

Inspect the gears for wear [Figure 20-60-14].

Figure 20-60-15

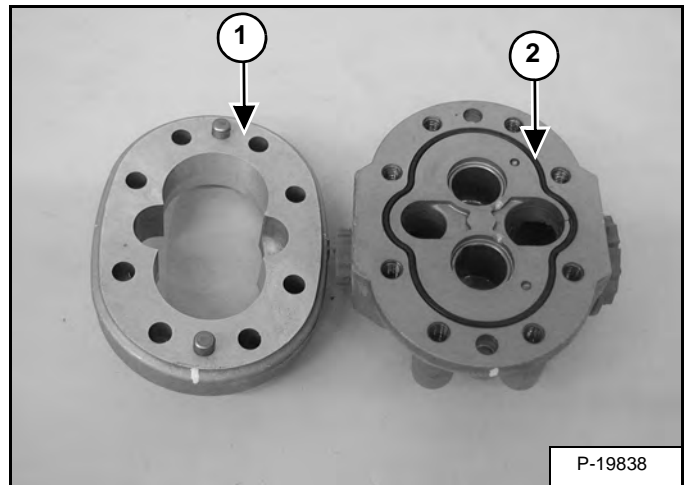

Remove the pump body (Item 1) [Figure 20-60-15] from the rear cover of the pump.

Remove the O-ring (Item 2) [Figure 20-60-15] from the rear cover.

Inspect the pump body and rear cover for wear.

Figure 20-60-16

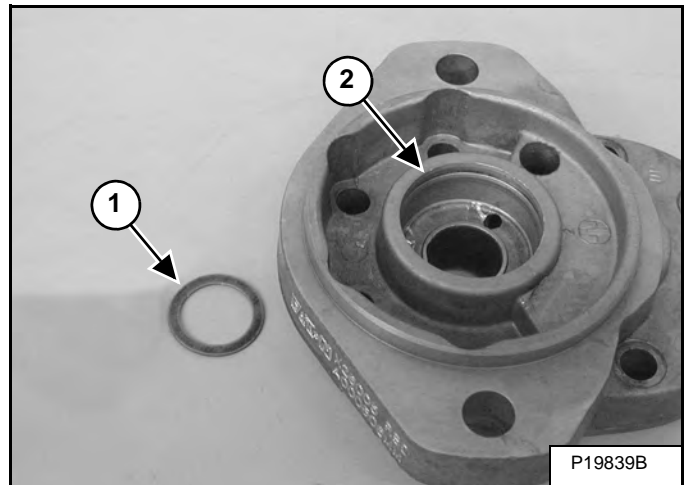

Remove the washer (Item 1) from the front cover (Item 2) [Figure 20-60-16].

HYDRAULIC / HYDROSTATIC FILTER

Description

The hydraulic / hydrostatic filter helps to remove contaminants from the hydraulic fluid when the hydraulic / hydrostatic systems are operating.

The hydraulic / hydrostatic filter housing contains the charge pressure relief valve.

The hydraulic / hydrostatic filter removes contaminants after the oil cooler.

Housing Removal And Installation



DANGER

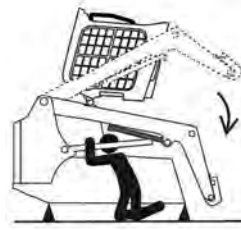

P-90328

AVOID DEATH

- Disconnecting or loosening any hydraulic tubeline, hose, fitting, component or a part failure can cause lift arms to drop.
- Keep out of this area when lift arms are raised unless supported by an approved lift arm support. Replace if damaged.

D-1009-0409



WARNING

Never work on a machine with the lift arms up unless the lift arms are secured by an approved lift arm support device. Failure to use an approved lift arm support device can allow the lift arms or attachment to fall and cause injury or death.

W-2059-0598

Put jackstands under the front and rear of the loader. (See Procedure on Page 10-10-1.)

Raise the lift arms and install the lift arm support device. (See Installing on Page 10-20-1.)

Raise the operator cab. (See Raising on Page 10-30-2.)

IMPORTANT

When repairing hydrostatic and hydraulic systems, clean the work area before disassembly and keep all parts clean. Always use caps and plugs on hoses, tubelines and ports to keep dirt out. Dirt can quickly damage the system.

I-2003-0888

HYDRAULIC / HYDROSTATIC FILTER (CONT'D)

Housing Removal And Installation (Cont'd)

Figure 20-70-1

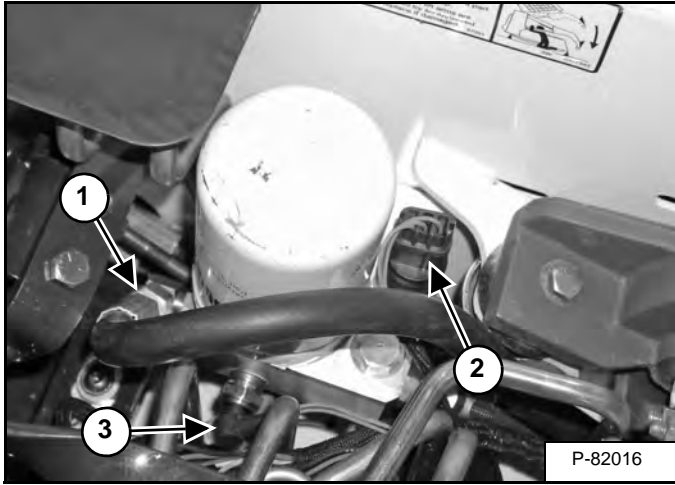

Disconnect the hose (Item 1) [Figure 20-70-1] from the filter block.

Disconnect the electrical connector from the charge pressure sender (Item 2) and the temperature sender (Item 3) [Figure 20-70-1].

Figure 20-70-2

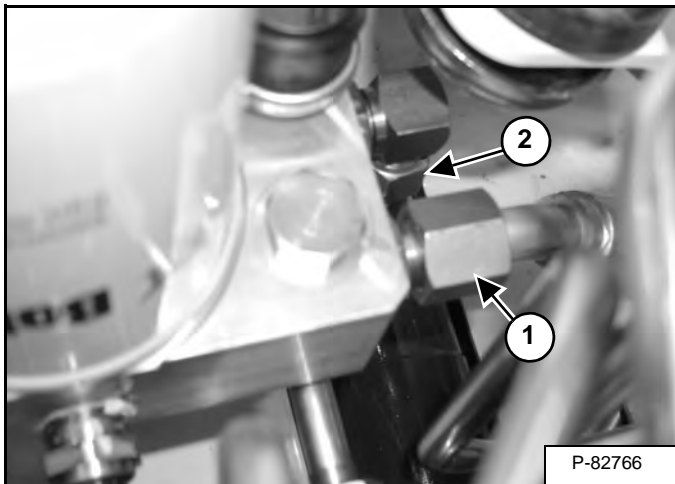

Remove the drain hose (Item 1) [Figure 20-70-2] from the filter block. *Later design: hose fitting and hose clamp.*

Remove the inlet tubeline (Item 2) [Figure 20-70-2] from the filter block.

Figure 20-70-3

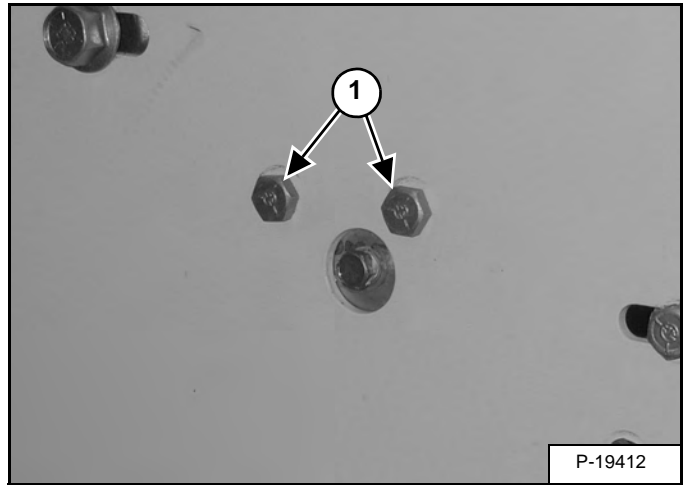

Remove the two mounting bolts (Item 1) [Figure 20-70-3] from the outside of the fender.

Remove the hydraulic filter block.

HYDRAULIC / HYDROSTATIC FILTER (CONT'D)

Housing Disassembly And Assembly

IMPORTANT

When repairing hydrostatic and hydraulic systems, clean the work area before disassembly and keep all parts clean. Always use caps and plugs on hoses, tubelines and ports to keep dirt out. Dirt can quickly damage the system.

I-2003-0888

Figure 20-70-4



Remove the filter (Item 1) [Figure 20-70-4].

Figure 20-70-5

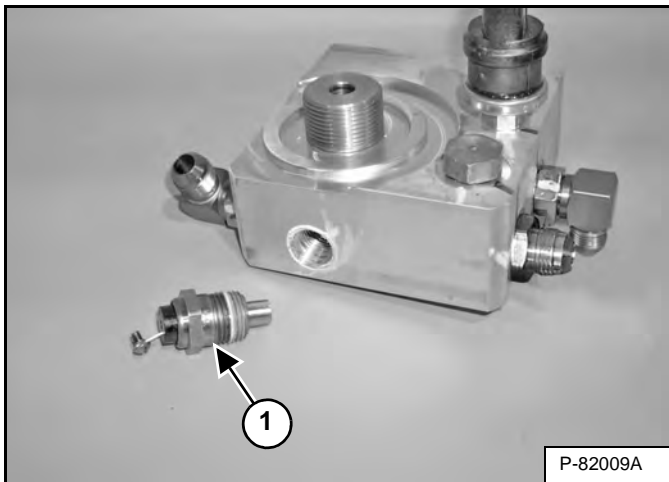

Remove the temperature sender (Item 1) [Figure 20-70-5] from the filter block.

Assembly: Apply thread sealer to the threads of the temperature sender before installing.

Figure 20-70-6

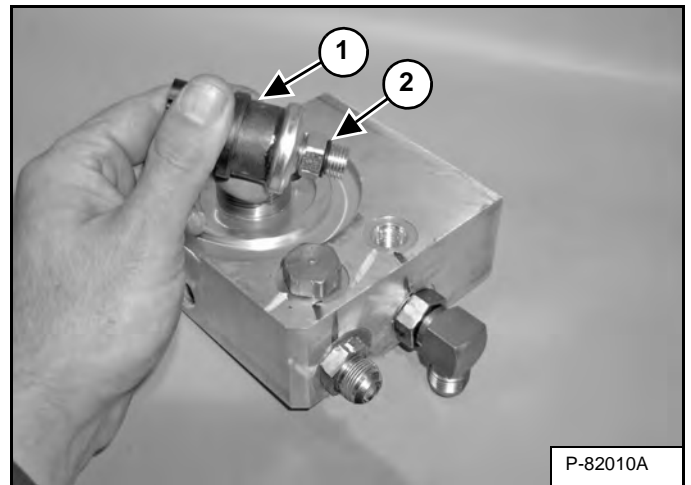

Remove the charge pressure sender (Item 1) [Figure 20-70-6] from the filter block.

Install a new O-ring (Item 2) [Figure 20-70-6] on the charge pressure sender.

Figure 20-70-7

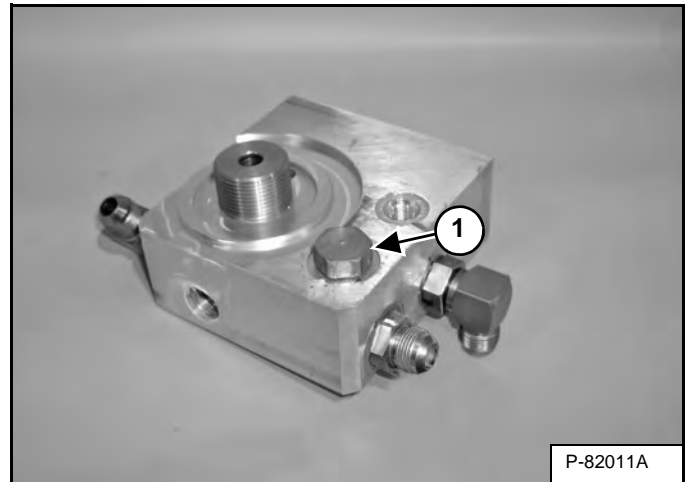

Remove the plug (Item 1) [Figure 20-70-7] from the filter block.

HYDRAULIC / HYDROSTATIC FILTER (CONT'D)

Housing Disassembly And Assembly (Cont'd)

Figure 20-70-8

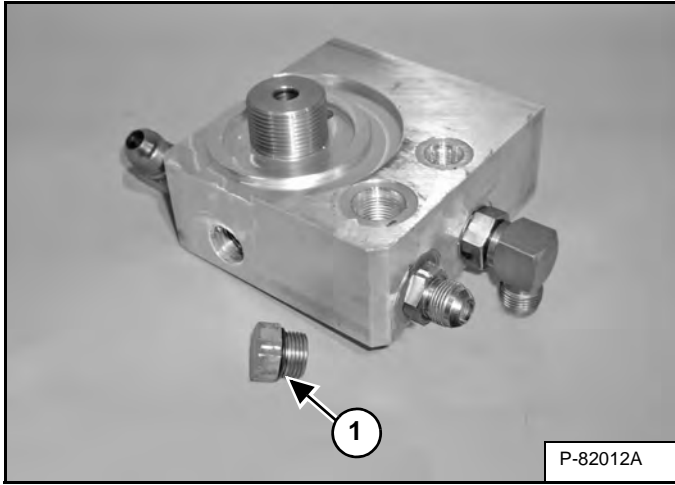

Remove the O-ring (Item 1) [Figure 20-70-8] from the plug.

Figure 20-70-9

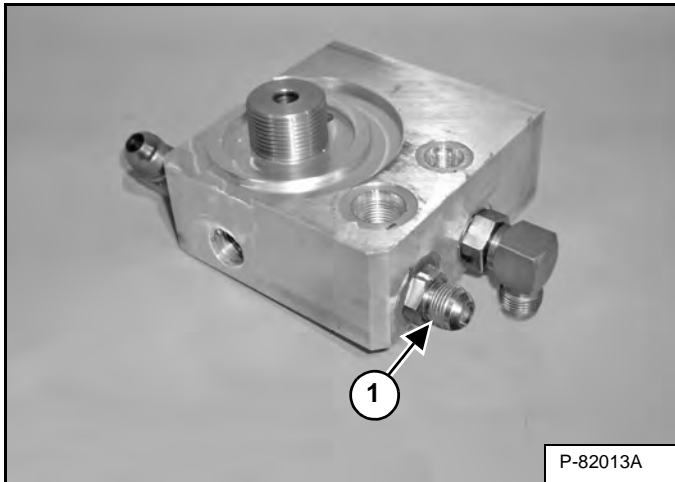

Remove the fitting (Item 1) [Figure 20-70-9] from the filter housing. *Later design: barbed hose fitting.*

Figure 20-70-10

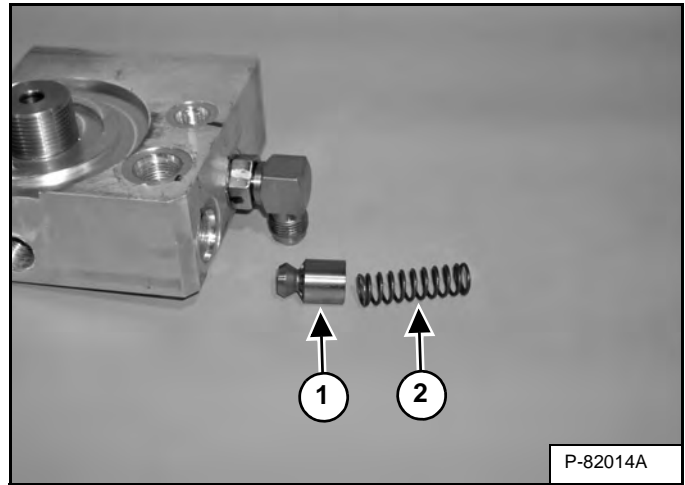

Remove the poppet (Item 1) and spring (Item 2) [Figure 20-70-10] from the filter housing.

HYDRAULIC FLUID RESERVOIR

Description

The hydraulic fluid reservoir is a storage container for the loaders hydraulic / hydrostatic fluid. The reservoir contains a vented fill cap with a fluid screen to prevent contaminants from entering the reservoir while adding fluid.

The hydraulic fluid reservoir is secured to the main frame below the operator's seat.

HYDRAULIC FLUID RESERVOIR (CONT'D)

Removal And Installation

Lift and block the loader. (See Procedure on Page 10-10-1.)

Remove the fluid from the hydraulic reservoir. (See Removing And Replacing Hydraulic / Hydrostatic Filter on Page 10-120-3.)

Raise the operator cab. (See Raising on Page 10-30-2.)

Remove the engine speed control. (See Removal And Installation on Page 70-20-1.)

Remove the center control shield and the steering lever covers. (See Control Shield And Steering Lever Panels Removal And Installation on Page 50-90-1.)

Remove the steering levers. (See Lever Removal And Installation on Page 50-100-1.)

IMPORTANT

When repairing hydrostatic and hydraulic systems, clean the work area before disassembly and keep all parts clean. Always use caps and plugs on hoses, tubelines and ports to keep dirt out. Dirt can quickly damage the system.

I-2003-0888

Figure 20-80-1

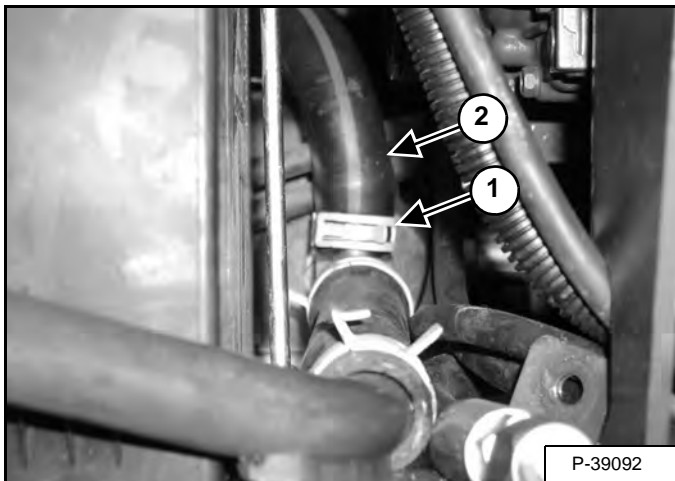

Loosen the clamp (Item 1) and remove the hose (Item 2) [Figure 20-80-1] from the hydraulic reservoir.

Figure 20-80-2

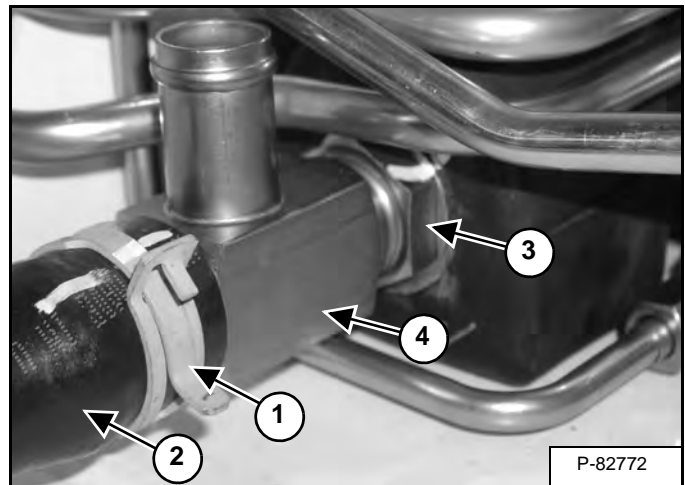

Loosen the clamp (Item 1) and remove the fill hose (Item 2) [Figure 20-80-2] from the fitting.

Loosen the locknut (Item 3) and turn the fitting (Item 4) [Figure 20-80-2] to the side to allow clearance when removing the reservoir.

Installation: Tighten the fitting (Item 3) [Figure 20-80-2] to 28 - 31 N•m (21 - 23 ft-lb).

Figure 20-80-3

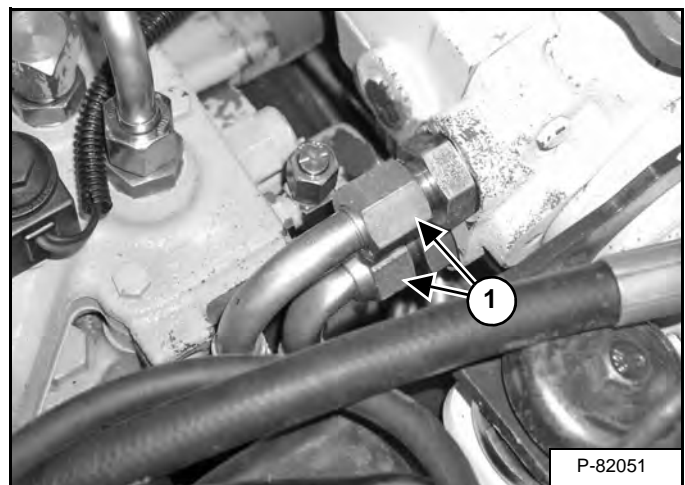

Disconnect the two drive motor hoses (Item 1) [Figure 20-80-3] from the left side of the hydrostatic pump and move out of the way.

HYDRAULIC FLUID RESERVOIR (CONT'D)

Removal And Installation (Cont'd)

Figure 20-80-4

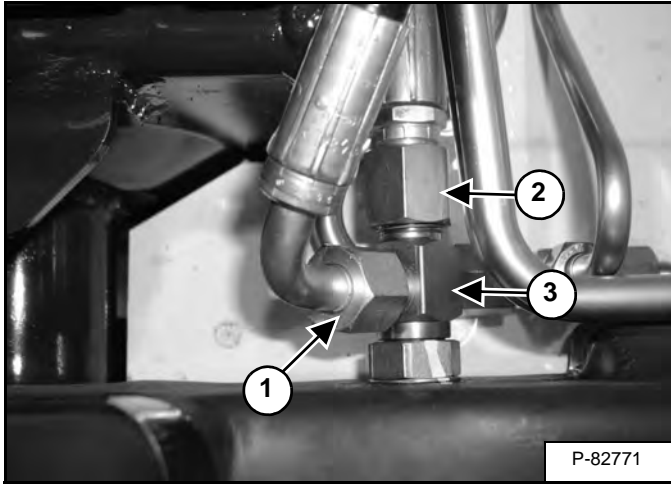

Disconnect the 90° hose (Item 1) [Figure 20-80-4] from the tee fitting located at the side of the hydraulic reservoir.

Disconnect the straight hose (Item 2) [Figure 20-80-4] from the tee fitting.

Remove the tee fitting (Item 3) [Figure 20-80-4] to prevent damage to the fitting and allow easier removal of the reservoir.

Figure 20-80-5

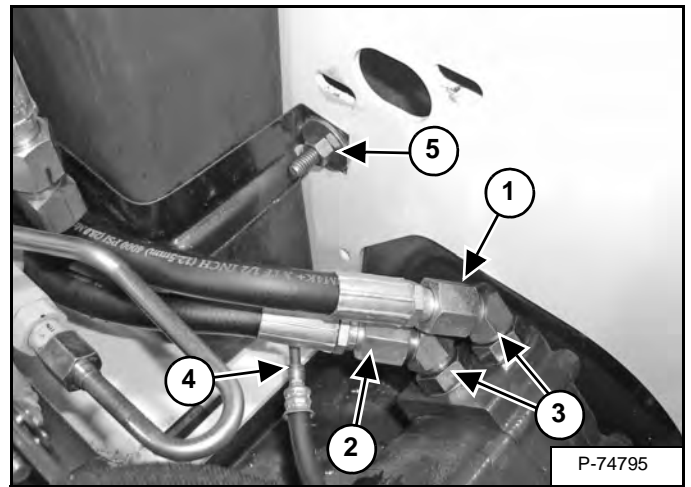

Disconnect the top drive motor hose (Item 1) [Figure 20-80-5] which connects to the top fitting on the hydrostatic pump.

Disconnect the lower drive motor hose (Item 2) [Figure 20-80-5] which connects to the bottom fitting on the hydrostatic pump.

Remove the fittings (Item 3) [Figure 20-80-5] from the drive motor.

Remove the return hose (Item 4) [Figure 20-80-5] from the hydraulic reservoir.

Remove the nut, washer and bolt (Item 5) [Figure 20-80-5] from the hydraulic reservoir holding strap.

NOTE: The nut and bolt holding the other end of the strap is located in front of the gear pump.

Remove the hydraulic reservoir.



Bobcat®

OIL COOLER

Description

The oil cooler cools the loaders hydraulic and hydrostatic oil. Oil passages are coiled into a heat exchanger. The cooling fan forces air around the passages cooling the oil.

The oil cooler is located below the radiator.

OIL COOLER (CONT'D)

Removal And Installation

Stop the engine and open the rear door.

! WARNING

AVOID INJURY OR DEATH

Always clean up spilled fuel or oil. Keep heat, flames, sparks or lighted tobacco away from fuel and oil. Failure to use care around combustibles can cause explosion or fire.

W-2103-0508

IMPORTANT

Always keep hydraulic and hydrostatic parts clean. Clean outside of all assemblies before beginning repairs. Use plugs and caps to cover open ports. Dirt can quickly damage the system.

I-2173-0598

Figure 20-90-1

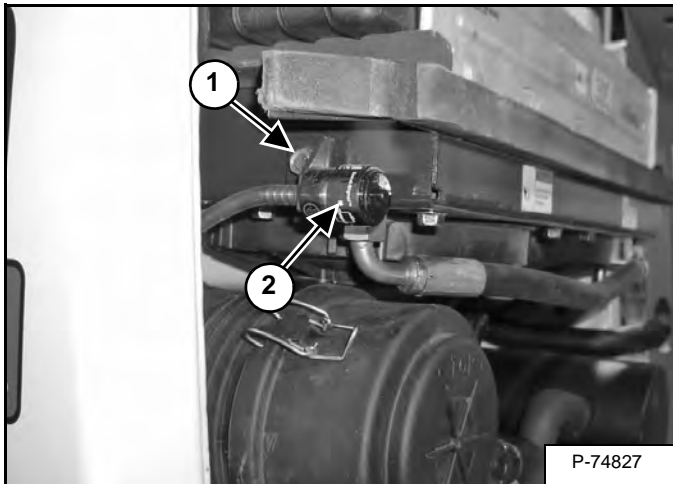

Remove the bolt (Item 1) and move the air cleaner indicator (Item 2) [Figure 20-90-1] out of the way.

Figure 20-90-2

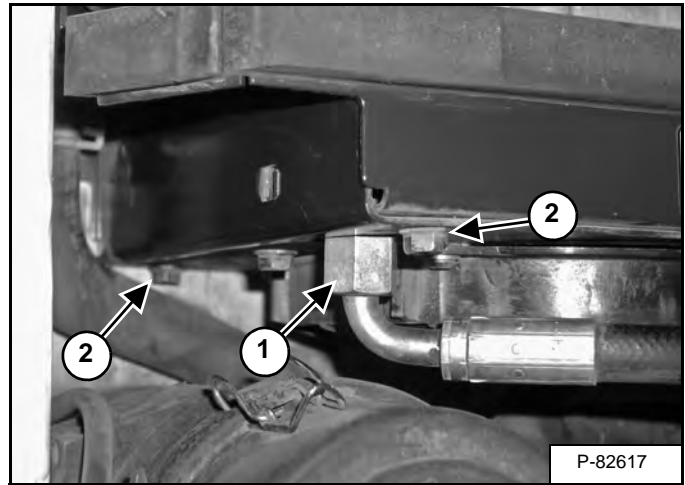

Disconnect the hose (Item 1) [Figure 20-90-2] from the oil cooler.

Remove the two bolts (Item 2) [Figure 20-90-2].

Figure 20-90-3

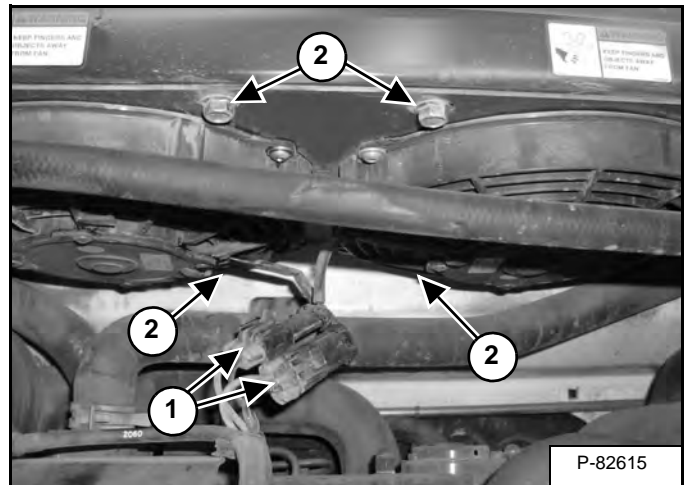

Disconnect the cooling fan connectors (Item 1) [Figure 20-90-3] from the loader harness.

Remove the four bolts (Item 2) [Figure 20-90-3].

OIL COOLER (CONT'D)

Removal And Installation (Cont'd)

Figure 20-90-4

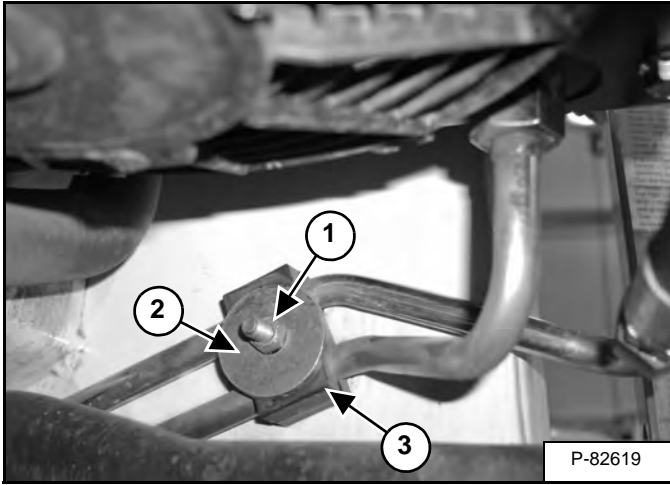

Remove the nut (Item 1) washer (Item 2) and grommet (Item 3) [Figure 20-90-4] to allow movement of the tubelines.

Figure 20-90-5

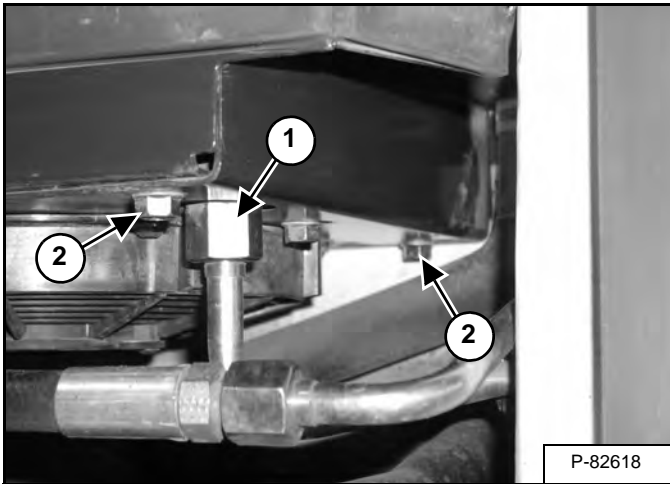

Disconnect the tubeline (Item 1) [Figure 20-90-5] from the oil cooler.

Remove the two bolts (Item 2) [Figure 20-90-5] and remove the oil cooler.

Figure 20-90-6

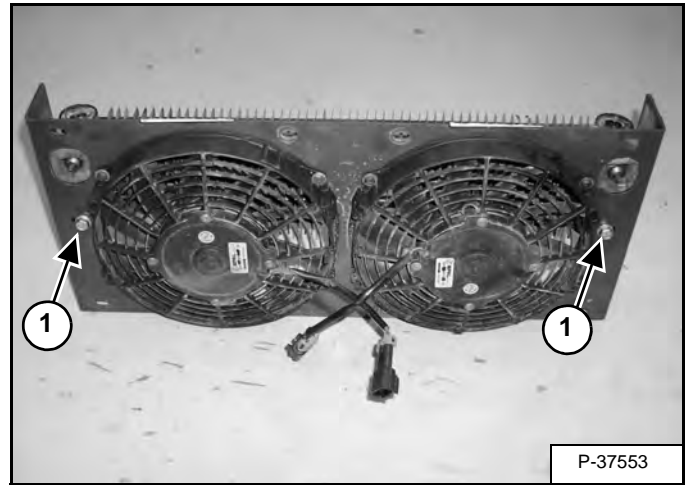

Remove the mounting bolts (Item 1) [Figure 20-90-6] to remove the oil cooler from the assembly.



Bobcat®

BUCKET POSITION VALVE

Description

The Bucket Position Valve is an option that allows the loader to meter the lift and tilt circuits. The metering of the lift and tilt circuits allows the operator to hold the attachment in the same relative position to the ground to maximum lift height without using the tilt function.

The bucket position valve is located below the operator cab below the left side of the control panel.

See Hydraulic Schematic for more circuit information.

Solenoid Removal And Installation

Figure 20-100-1

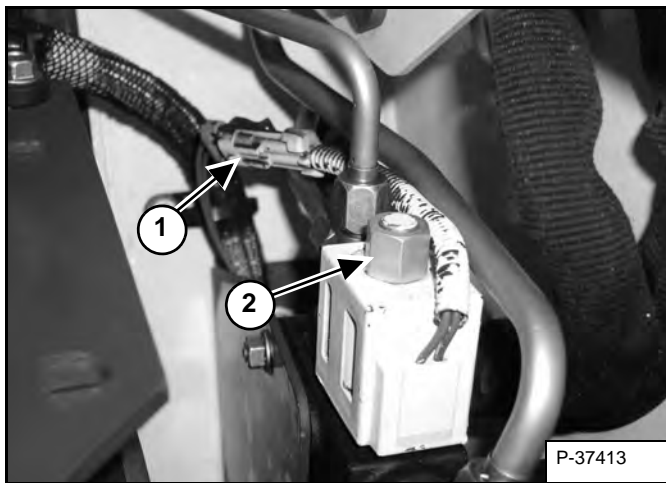

Raise the operator cab. (See Raising on Page 10-30-2.).

Disconnect the wire harness connector (Item 1) [Figure 20-100-1] from the bucket position shutoff solenoid.

Remove the solenoid nut (Item 2) [Figure 20-100-1].

Installation: Tighten the solenoid nut to 6,78 N•m (60 in-lb) torque.

Remove the solenoid.

Figure 20-100-2

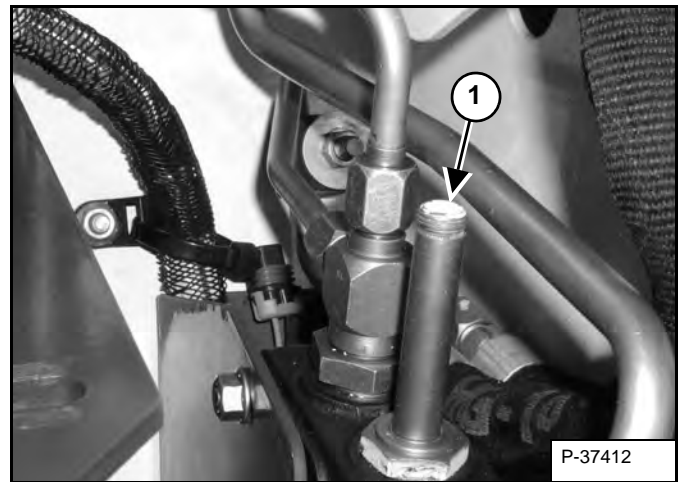

Remove the solenoid stem (Item 1) [Figure 20-100-2] from the bucket position valve.

Installation: Tighten the solenoid stem to 40,8 - 47,6 N•m (30 - 35 ft-lb) torque.

Figure 20-100-3

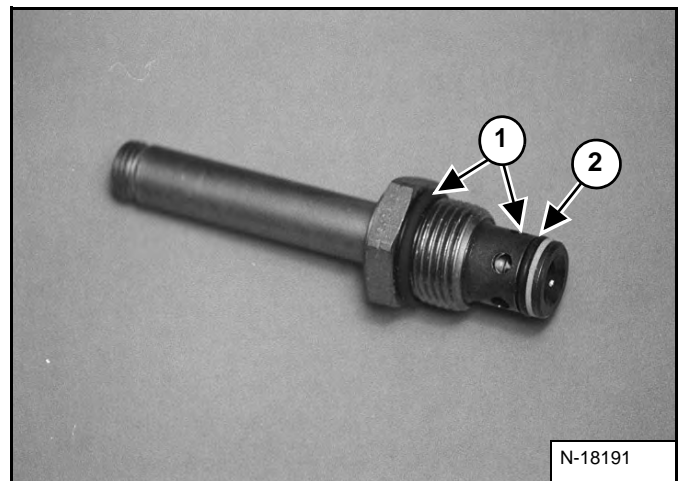

Inspect the solenoid stem and replace the O-rings (Item 1) and back-up washers (Item 2) [Figure 20-100-3].

Installation: Put oil on O-rings and back-up ring.

BUCKET POSITION VALVE (CONT'D)

Solenoid Testing

Figure 20-100-4



Use a test meter to measure coil resistance **[Figure 20-100-4]**. Coil wires do not have polarity. Correct resistance for the coil is $9.7 \text{ ohm} \pm 1 \text{ ohm}$ @ $25,5^{\circ}\text{C}$ (78°F).

Replace the test meter with 12 volt power you can see and hear the spool shift.

BUCKET POSITION VALVE (CONT'D)

Removal And Installation

IMPORTANT

When repairing hydrostatic and hydraulic systems, clean the work area before disassembly and keep all parts clean. Always use caps and plugs on hoses, tubelines and ports to keep dirt out. Dirt can quickly damage the system.

I-2003-0888

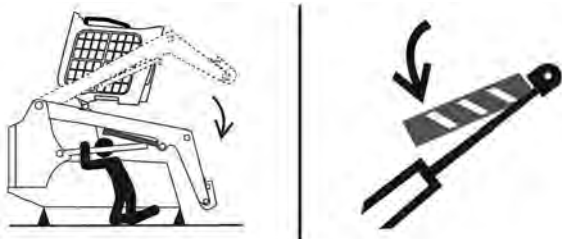

P-90328

AVOID DEATH

- Disconnecting or loosening any hydraulic tubeline, hose, fitting, component or a part failure can cause lift arms to drop.
- Keep out of this area when lift arms are raised unless supported by an approved lift arm support. Replace if damaged.

D-1009-0409

WARNING

Never work on a machine with the lift arms up unless the lift arms are secured by an approved lift arm support device. Failure to use an approved lift arm support device can allow the lift arms or attachment to fall and cause injury or death.

W-2059-0598

Start the engine.

Raise the lift arms and install an approved lift arm support device. (See LIFT ARM SUPPORT DEVICE on Page 10-20-1.).

Stop the engine.

Raise the operator cab. (See Raising on Page 10-30-2.)

NOTE: Before disconnecting the hydraulic tubelines from the bucket position valve, first mark the tubelines and the fittings of the bucket position valve to make sure the tubelines will be put on the right fitting while reconnecting the tubelines.

Figure 20-100-5

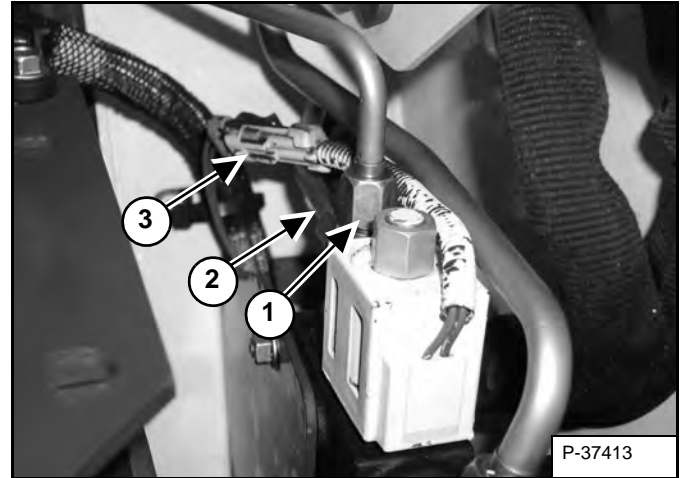

P-37413

Remove the solenoid (Item 1) [Figure 20-100-5] from the hydraulic control valve by removing the nut.

Installation: Tighten the solenoid nut to 6,78 N•m (60 in-lb) torque.

Remove the tubeline (Item 1) [Figure 20-100-5] from the A port fitting.

Remove the tubeline (Item 2) [Figure 20-100-5] from the A port fitting.

Disconnect the wire harness connector (Item 3) [Figure 20-100-5] from the solenoid.

Figure 20-100-6

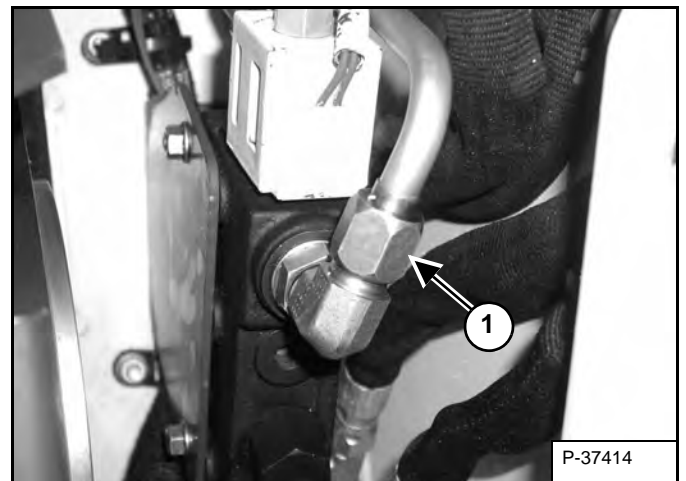

P-37414

Remove the tubeline (Item 1) [Figure 20-100-6] from the "B" port fitting.

BUCKET POSITION VALVE (CONT'D)

Removal And Installation (Cont'd)

Figure 20-100-7

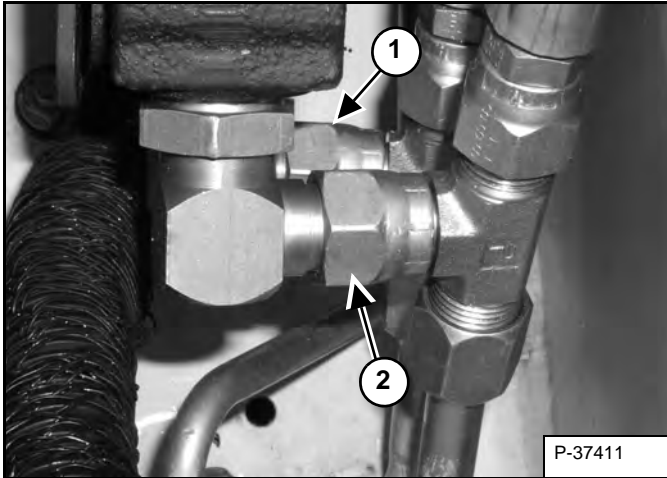

Remove the tee fitting (Item 1) [Figure 20-100-5] from the “D” port fitting.

Remove the tee fitting (Item 2) [Figure 20-100-7] from the “C” port fitting.

Figure 20-100-8

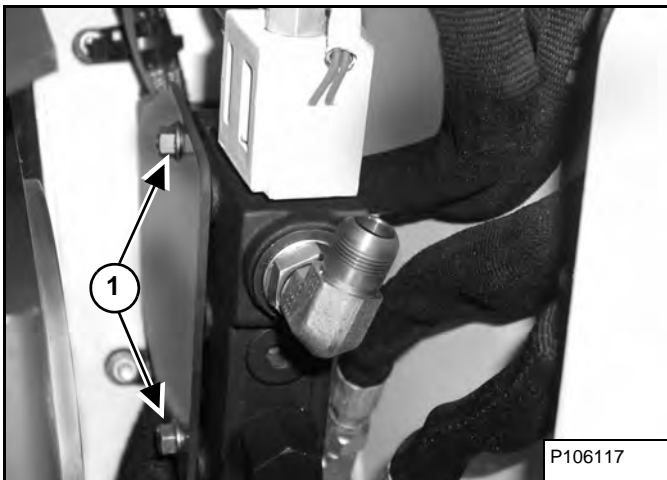

Remove the two nuts / bolts (Item 1) [Figure 20-100-8].

Remove the bucket position valve.

BUCKET POSITION VALVE (CONT'D)

Disassembly And Assembly

Figure 20-100-9

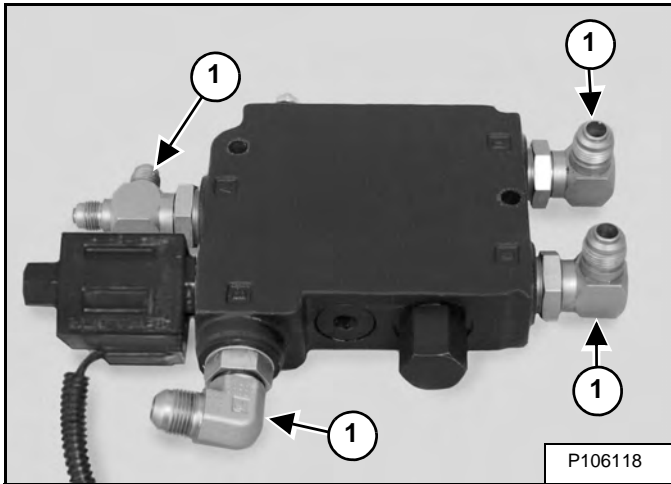

Mark and remove the fittings (Item 1) [Figure 20-100-9].

Figure 20-100-10

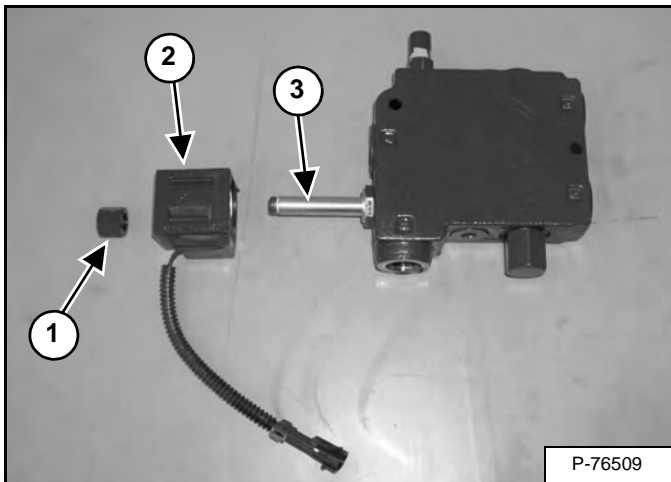

Remove the solenoid nut (Item 1), the solenoid (Item 2), and the solenoid stem (Item 3) [Figure 20-100-10] from the bucket position valve.

Installation: Tighten the nut to 6,78 N•m (60 in-lb) torque.

Installation: Put oil on O-rings and back-up rings, tighten the solenoid stem to 40,8 - 47,6 N•m (30 - 35 ft-lb) torque.

Figure 20-100-11

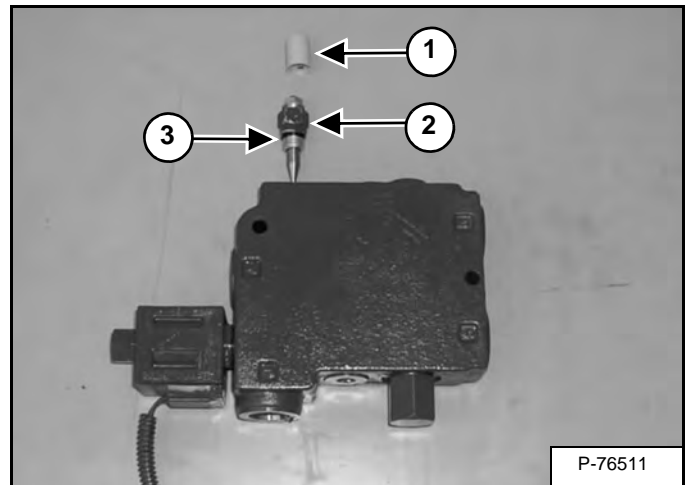

Remove the cap (Item 1), the flow adjustment valve (Item 2), and the O-ring (Item 3) [Figure 20-100-11].

NOTE: Always install new O-rings before any parts are installed into the valve. Inspect the parts for wear or damage and replace as needed.

Figure 20-100-12

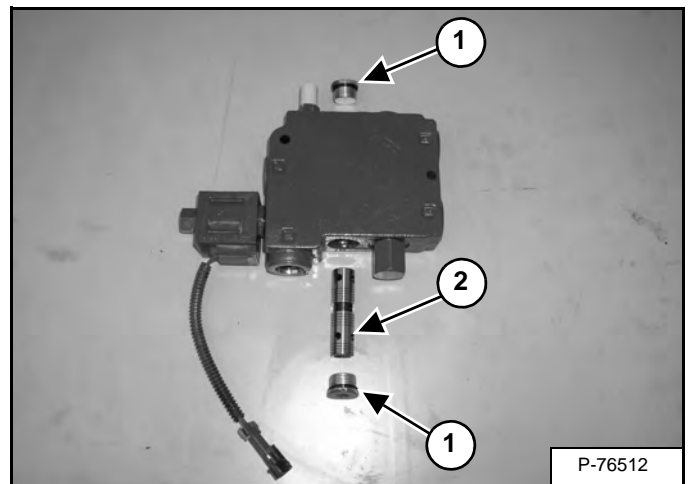

Remove the plugs (Item 1) and flow control spool (Item 2) [Figure 20-100-12].

Installation: Tighten the plugs to 76 - 86,7 N•m (56 - 64 ft-lb) torque.

Inspect the flow control spool for wear, inspect the O-ring on the plug and replace as needed.

BUCKET POSITION VALVE (CONT'D)

Disassembly And Assembly (Cont'd)

Figure 20-100-13

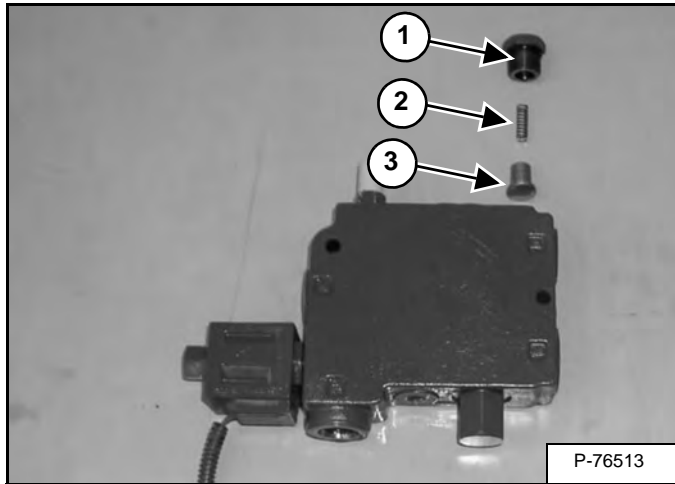

Remove the plug (Item 1), spring (Item 2), and the tilt cylinder check valve (Item 3) [Figure 20-100-13]. Inspect for wear, inspect the O-ring and replace as needed.

Installation: Tighten the plug to 76 - 86,7 N•m (56 - 64 ft-lb) torque.

Figure 20-100-14

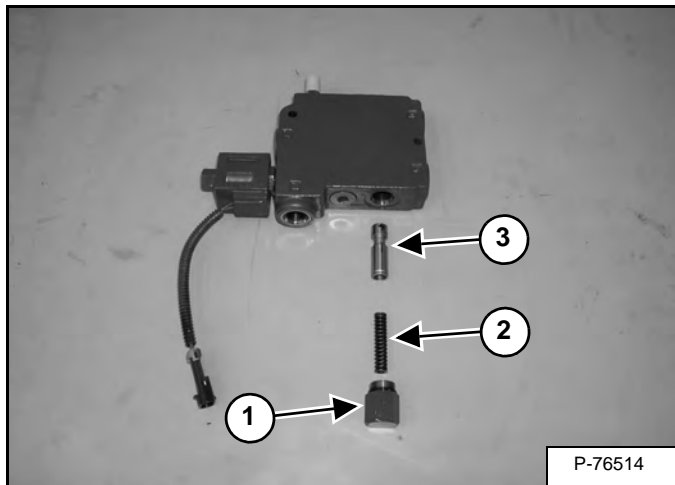

Remove the plug (Item 1), spring (Item 2), and unloading spool (Item 3) [Figure 20-100-14].

Inspect all parts and replace as needed. Install a new O-ring on the plug before installing.

Installation: Tighten the plug to 76 - 86,7 N•m (56 - 64 ft-lb) torque.

AUXILIARY HYDRAULIC INTERLOCK VALVE

Description

The auxiliary hydraulic interlock valve has a single solenoid stem that is normally closed. The operation of the valve is controlled by an electric solenoid.

The auxiliary hydraulic interlock valve prevents or allows hydraulic fluid to flow to the auxiliary couplers.

The auxiliary hydraulic interlock valve is located on the left side of the frame just above the battery.

Removal And Installation

Open the rear door.

WARNING

AVOID INJURY OR DEATH

Always clean up spilled fuel or oil. Keep heat, flames, sparks or lighted tobacco away from fuel and oil. Failure to use care around combustibles can cause explosion or fire.

W-2103-0508

IMPORTANT

Always keep hydraulic and hydrostatic parts clean. Clean outside of all assemblies before beginning repairs. Use plugs and caps to cover open ports. Dirt can quickly damage the system.

I-2173-0598

Figure 20-110-1

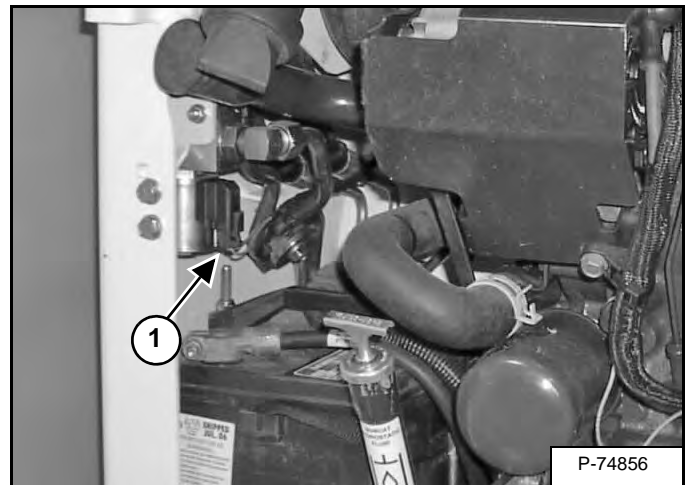

Disconnect the electrical connector (Item 1) [Figure 20-110-1] from the auxiliary hydraulic interlock valve.

Figure 20-110-2

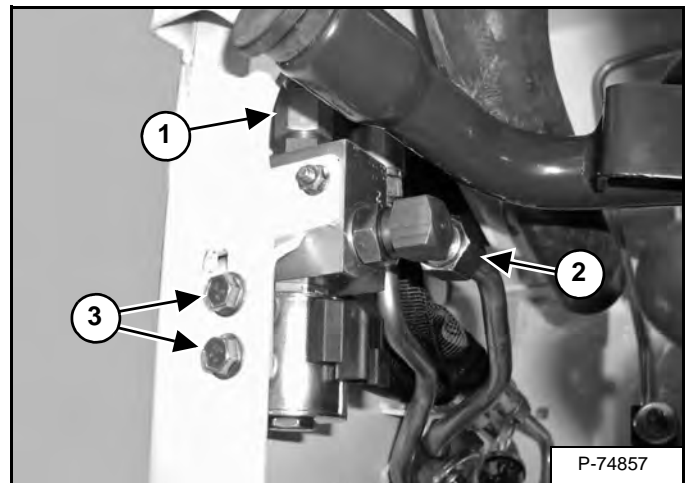

Remove the hose (Item 1) and tubeline (Item 2) [Figure 20-110-2] from the auxiliary hydraulic interlock valve.

Remove the two mounting bolts and nuts (Item 3) [Figure 20-110-2] securing the auxiliary hydraulic interlock valve bracket to the frame.

Remove the auxiliary hydraulic interlock valve.

AUXILIARY HYDRAULIC INTERLOCK VALVE (CONT'D)

Disassembly And Assembly

Figure 20-110-3

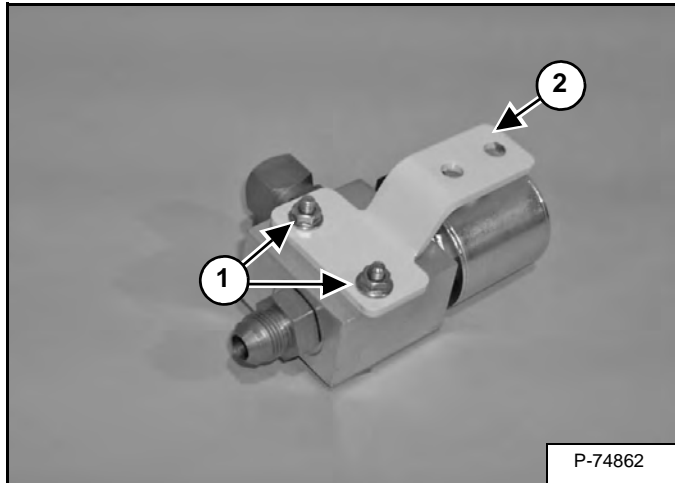

Remove the two bolts and nuts (Item 1) and remove the bracket (Item 2) [Figure 20-110-3].

Figure 20-110-4

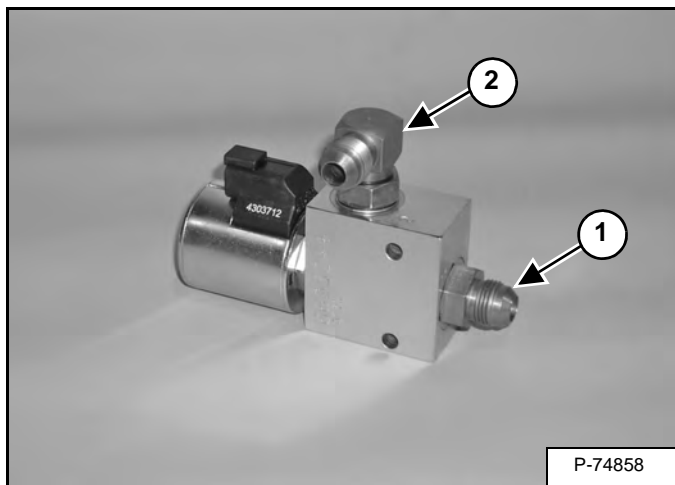

Remove the straight fitting (Item 1) and 90° fitting (Item 2) [Figure 20-110-4] from the auxiliary hydraulic interlock valve.

Figure 20-110-5

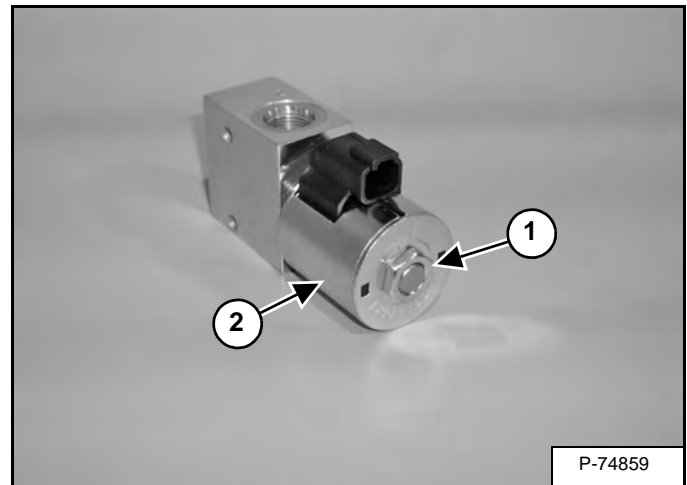

Remove the solenoid nut (Item 1) and coil (Item 2) [Figure 20-110-5].

Assembly: Tighten the nut to 7 N•m (5 ft-lb) torque

Figure 20-110-6

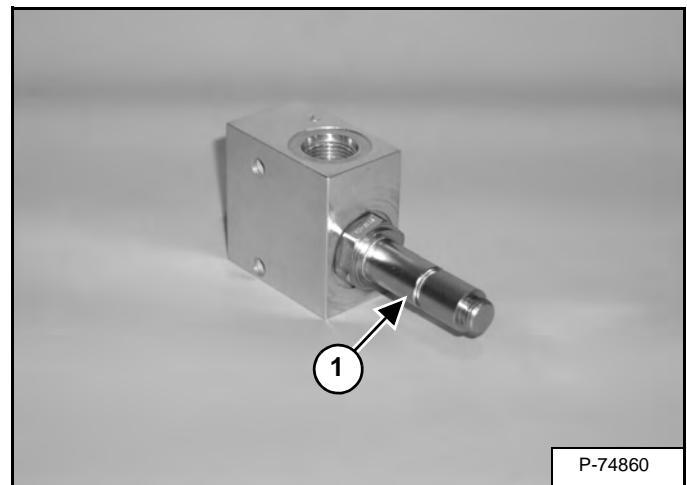

Remove the normally closed solenoid stem (Item 1) [Figure 20-110-6] from the auxiliary hydraulic interlock valve.

Assembly: Tighten the poppet valve to 41 - 47 N•m (30 - 35 ft-lb) torque.

AUXILIARY HYDRAULIC INTERLOCK VALVE (CONT'D)

Disassembly And Assembly (Cont'd)

Figure 20-110-7

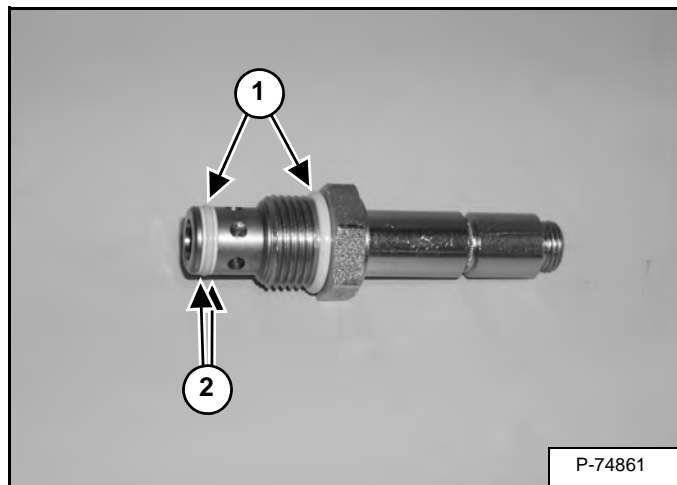

Inspect the O-rings (Item 1) and back-up rings (Item 2) [Figure 20-110-7] for damage. Replace as needed.



Bobcat®

HYDROSTATIC SYSTEM

HYDROSTATIC SYSTEM INFORMATION	30-10-1
Description	30-10-1
Troubleshooting	30-10-2
HYDROSTATIC DRIVE MOTOR	30-20-1
Description	30-20-1
Removal And Installation	30-20-1
Parts Identification	30-20-3
Disassembly	30-20-4
Assembly	30-20-10
CHARGE PRESSURE	30-30-1
Description	30-30-1
Testing	30-30-1
Sender Removal And Installation	30-30-3
HYDROSTATIC PUMP	30-40-1
Description	30-40-1
Replenishing / High Pressure Relief Valve Removal And Installation	30-40-1
Removal And Installation	30-40-2
Parts Identification	30-40-5
Disassembly	30-40-6
Assembly	30-40-11
DRIVE BELT	30-50-1
Description	30-50-1
Adjusting	30-50-1
Belt Removal And Installation	30-50-1
Tensioner Pulley Removal And Installation	30-50-2
Tensioner Pulley Disassembly And Assembly	30-50-2



Bobcat®

HYDROSTATIC SYSTEM INFORMATION

Description

The hydrostatic system consists of a tandem hydrostatic pump and two hydrostatic motors. The hydrostatic system allows forward and reverse motion of the loader.

The hydrostatic pump is connected to the engine by drive belt and provides fluid to the hydrostatic motors. The charge pressure system assists in replenishing the fluid that is lost due to internal leakage in the components of the hydrostatic system.

IMPORTANT

When repairing hydrostatic and hydraulic systems, clean the work area before disassembly and keep all parts clean. Always use caps and plugs on hoses, tubelines and ports to keep dirt out. Dirt can quickly damage the system.

I-2003-0888

HYDROSTATIC SYSTEM INFORMATION (CONT'D)

Troubleshooting

The following troubleshooting chart is provided for assistance in locating and correcting problems which are most common. Many of the recommended procedures must be done by authorized Bobcat Service Personnel only.



WARNING

Check for correct function after adjustments, repairs or service. Failure to make correct repairs or adjustments can cause injury or death.

W-2004-1285

PROBLEM	CAUSE
No drive on one side, in one direction.	1, 2, 3, 4, 5, 19
No drive on one side in both directions.	2, 3, 5, 6, 7, 8
The loader does not move in a straight line.	2, 3, 4, 6, 7, 8, 9, 10, 19
the hydrostatic system is overheating.	4, 11, 12, 13, 14, 15
The oil light comes on.	16, 17, 18

KEY TO CORRECT THE CAUSE

1. The hydrostatic system has a fluid leak.
2. The steering linkage needs adjustment.
3. The high pressure relief valve(s) are defective.
4. The shuttle valve in the hydrostatic motor has a defect.
5. The balance plate in the hydrostatic motor seals are defective.
6. The hydrostatic pumps have a defect.
7. The final drive chain is broken.
8. The hydrostatic motor has a defect.
9. The tires do not have the correct tire pressure.
10. The tires are not the same size.
11. The hydrostatic fluid is not at the correct level.
12. The oil cooler has a restriction (Externally or Internally).
13. The temperature sending switch is not operating correctly.
14. The control valve is not operating correctly.
15. The loader is not being operated at the correct rpm.
16. The sender has a defect.
17. There is low charge pressure.
18. The charge relief has a defect.
19. Steering lever is obstructed.

HYDROSTATIC DRIVE MOTOR

Description

There are two hydrostatic motors, one on each side of the transmission tub which houses the drive chains.

The hydrostatic motors do not have an internal brake.

The hydrostatic motors are driven by high pressure from the hydrostatic pumps.

Removal And Installation

WARNING

Put jackstands under the front axles and rear corners of the frame before running the engine for service. Failure to use jackstands can allow the machine to fall or move and cause injury or death.

W-2017-0286

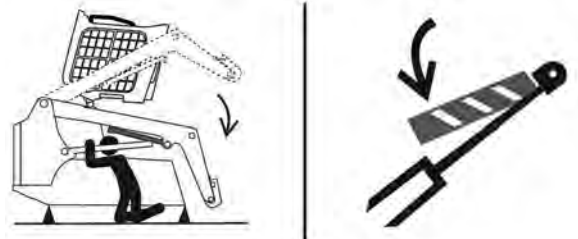

P-90328

AVOID DEATH

- **Disconnecting or loosening any hydraulic tubeline, hose, fitting, component or a part failure can cause lift arms to drop.**
- **Keep out of this area when lift arms are raised unless supported by an approved lift arm support. Replace if damaged.**

D-1009-0409

WARNING

Never work on a machine with the lift arms up unless the lift arms are secured by an approved lift arm support device. Failure to use an approved lift arm support device can allow the lift arms or attachment to fall and cause injury or death.

W-2059-0598

Lift and block the loader. (See Procedure on Page 10-10-1.)

Raise the lift arms and install the lift arm support device. (See Installing on Page 10-20-1.)

Remove the wheels from the side of the loader where the motor is to be removed. (See Wheel Nuts on Page 10-170-1.)

Raise the operator cab. (See Raising on Page 10-30-2.)

Remove the control shield and lever panels. (See Control Shield And Steering Lever Panels Removal And Installation on Page 50-90-1.)

HYDROSTATIC DRIVE MOTOR (CONT'D)

Removal And Installation (Cont'd)

Figure 30-20-1

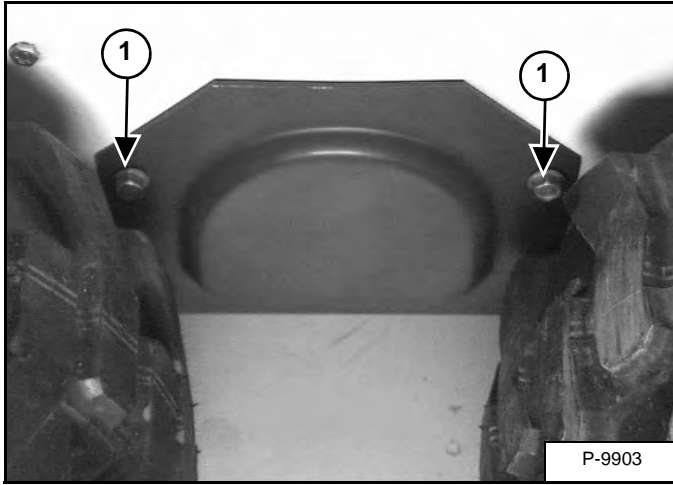

Remove the motor cover bolts (Item 1) [Figure 30-20-1] from the outside of the loader.

Pull the cover outward and free from the slots under the frame.

IMPORTANT

When repairing hydrostatic and hydraulic systems, clean the work area before disassembly and keep all parts clean. Always use caps and plugs on hoses, tubelines and ports to keep dirt out. Dirt can quickly damage the system.

I-2003-0888

IMPORTANT

When repairing hydrostatic and hydraulic systems, clean the work area before disassembly and keep all parts clean. Always use caps and plugs on hoses, tubelines and ports to keep dirt out. Dirt can quickly damage the system.

I-2003-0888

Figure 30-20-2

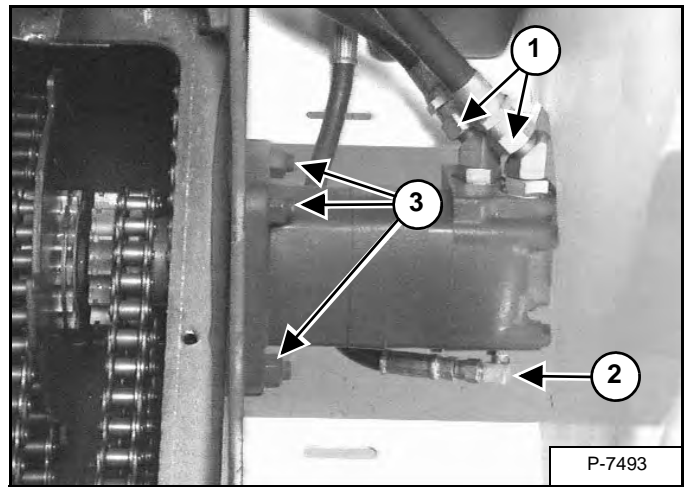

NOTE: Mark the hoses for installation purposes.

Remove the parking brake cover from the chaincase. (See Chaincase Cover Removal And Installation on Page 40-30-1.)

NOTE: Always use caps and plugs on hoses and fittings during disassembly and assembly.

Remove the high pressure hoses (Item 1), and drain hose (Item 2) [Figure 30-20-2] from the motor. Cap and plug the hoses and fittings.

Remove the four motor mounting nuts (Item 3) [Figure 30-20-2].

Installation: Lift the drive sprocket to align it with the motor splines. Be sure the O-ring is installed on the motor flange during installation. Tighten the nuts to 123 - 135 N•m (90 - 100 ft-lb) torque.

Remove the motor from the chaincase.

HYDROSTATIC DRIVE MOTOR (CONT'D)

Parts Identification

- 1. O-ring
- 2. Plate, Valve
- 3. Valve
- 4. Plate, Balancing
- 5. Seal, Inner
- 6. Seal, Outer
- 7. Plug
- 8. Pin
- 9. Spring
- 10. Housing
- 11. Bolt
- 12. Seal
- 13. Housing
- 14. Shaft And Bearing Assembly
- 15. Plate, Wear
- 16. Shaft, Long
- 17. Geroler®
- 18. Shaft, Short
- 19. Ball

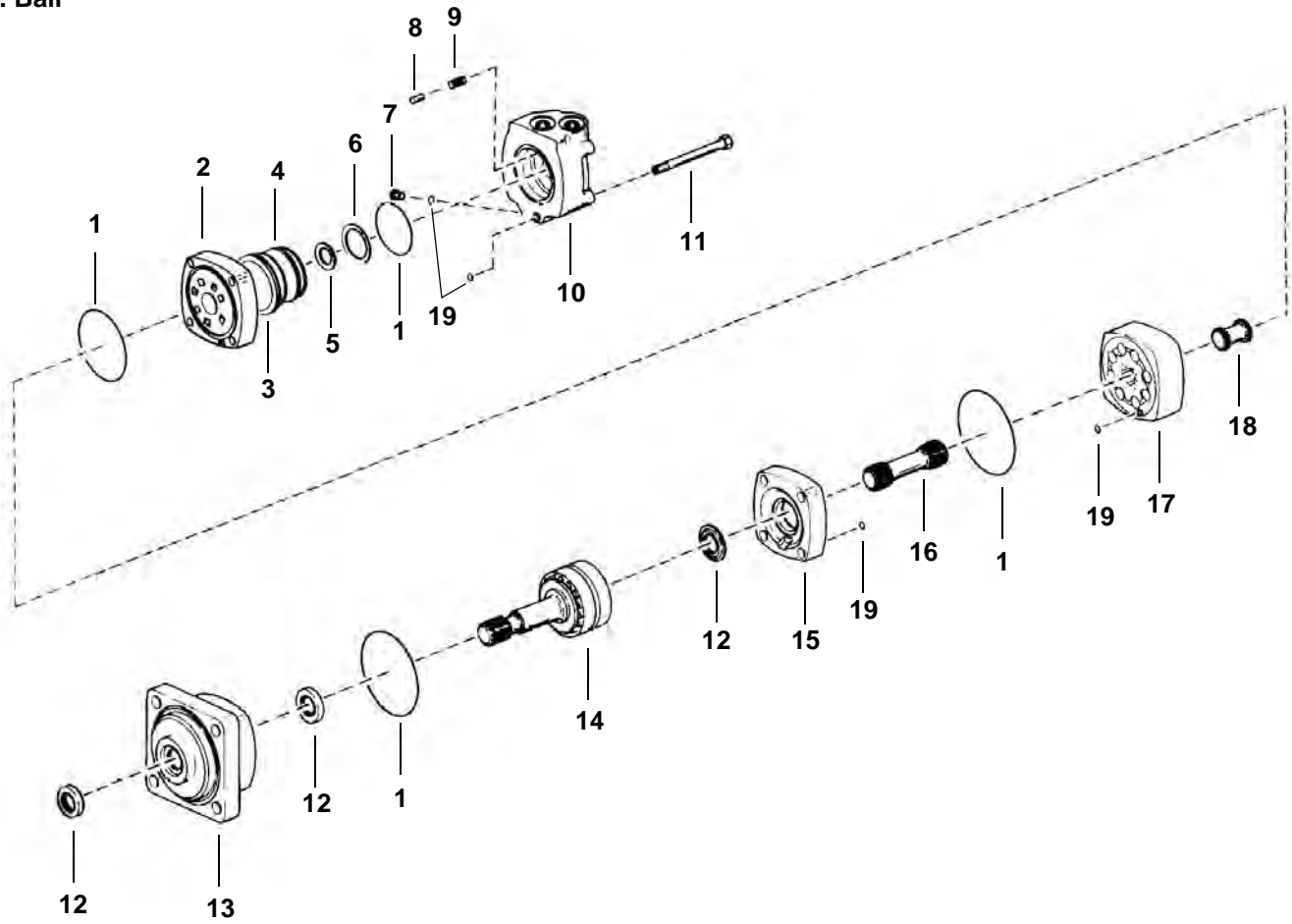

D-1635

HYDROSTATIC DRIVE MOTOR (CONT'D)

Disassembly

IMPORTANT

When repairing hydrostatic and hydraulic systems, clean the work area before disassembly and keep all parts clean. Always use caps and plugs on hoses, tubelines and ports to keep dirt out. Dirt can quickly damage the system.

I-2003-0888

Figure 30-20-3

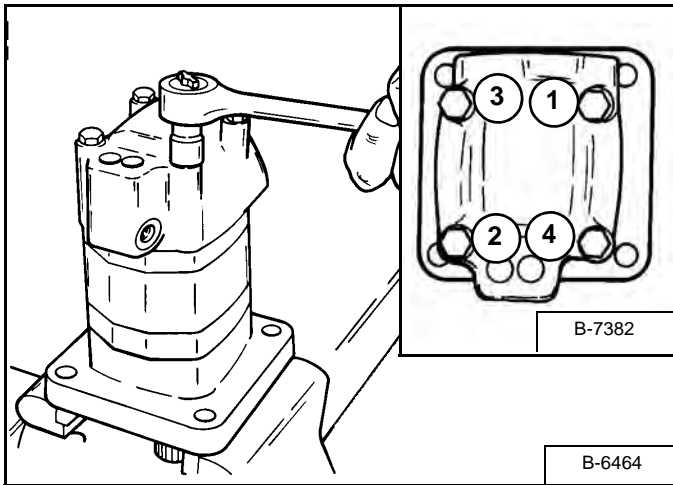

NOTE: Clean the outside of the motor before disassembly. Keep all the parts of the motor clean.

Put the motor in a vise, holding it by the mounting flange with the shaft down [Figure 30-20-3]. Put a mark across the motor housing for correct assembly.

Remove the four bolts from the motor [Figure 30-20-3].

Installation: Tighten the bolts to 50 N•m (37 ft-lb) torque in the sequence shown [Figure 30-20-3].

Figure 30-20-4

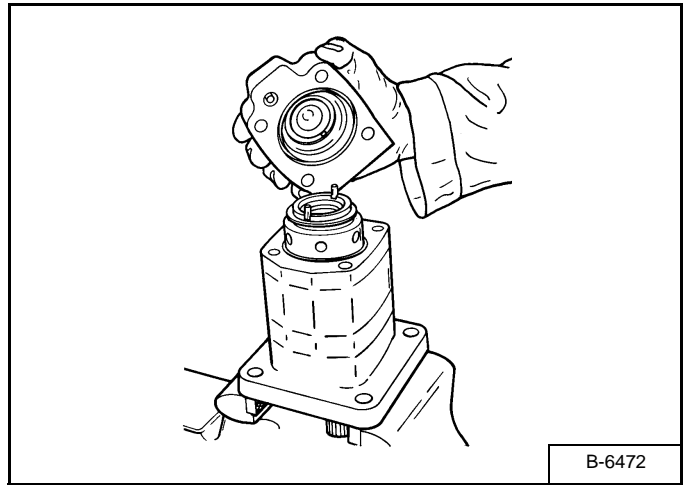

Lift the valve house straight up [Figure 30-20-4]. If done carefully the balance ring assembly and valve will stay on the valve plate.

Figure 30-20-5

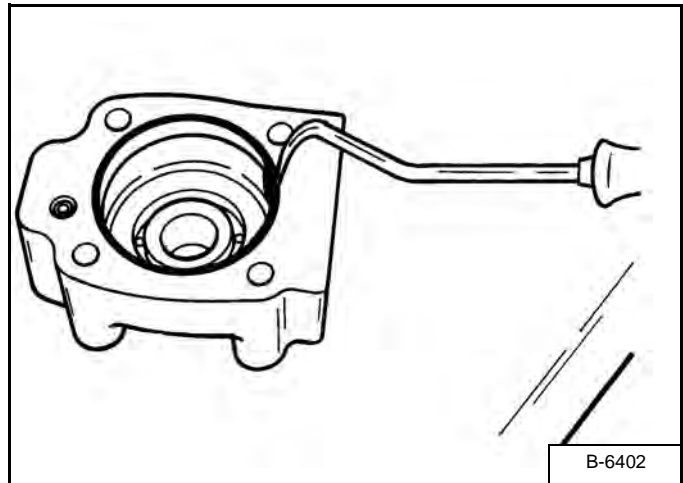

Remove the 76 mm (3 in) diameter O-ring from the valve housing [Figure 30-20-5].

HYDROSTATIC DRIVE MOTOR (CONT'D)

Disassembly (Cont'd)

Figure 30-20-6

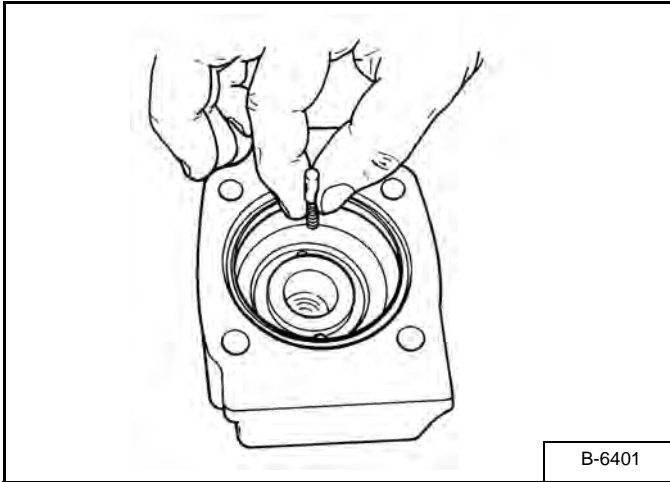

Remove the pins and springs from the valve housing [Figure 30-20-6].

Figure 30-20-7

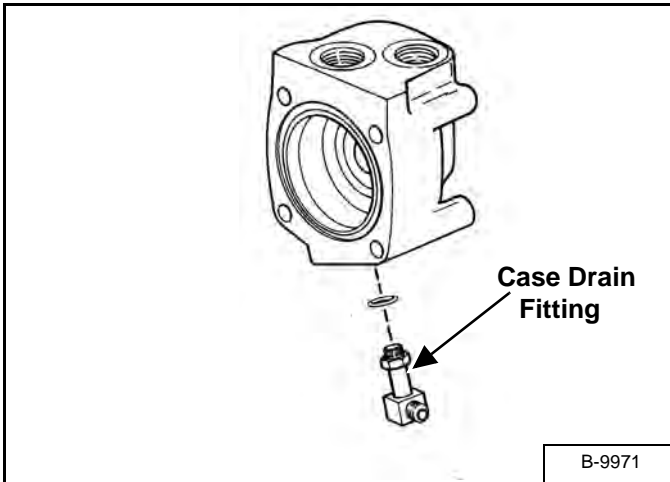

Remove the case drain fitting from the valve housing [Figure 30-20-7].

Figure 30-20-8

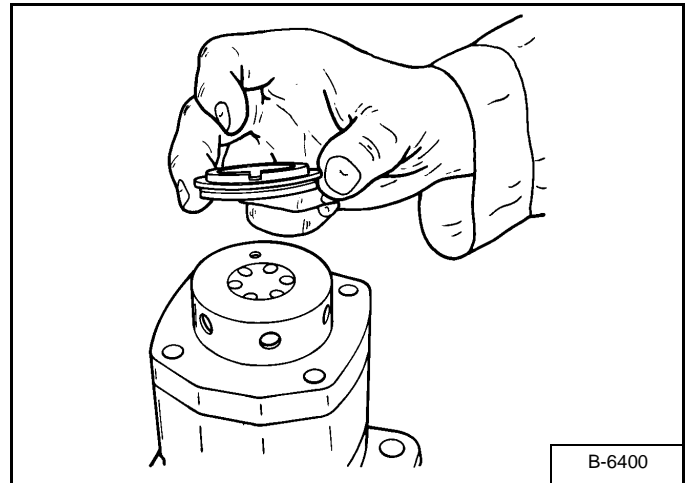

Remove the balance ring assembly [Figure 30-20-8].

Figure 30-20-9

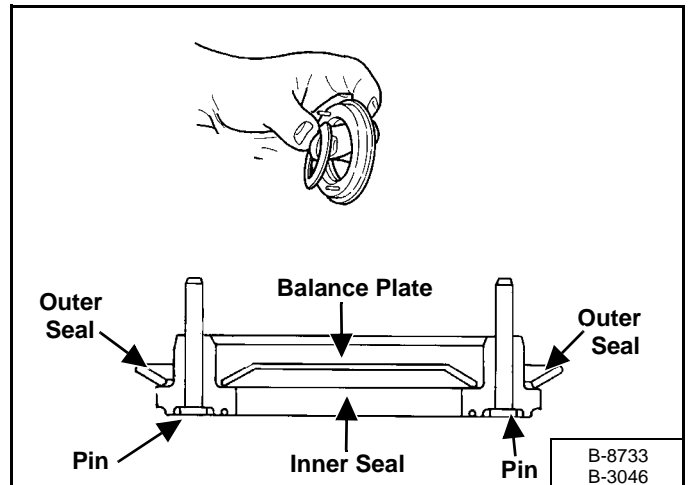

Remove the inner face seal from the balance plate [Figure 30-20-9]. Remove the spring.

Installation: Put grease on the inner seal during assembly.

HYDROSTATIC DRIVE MOTOR (CONT'D)

Disassembly (Cont'd)

Figure 30-20-10

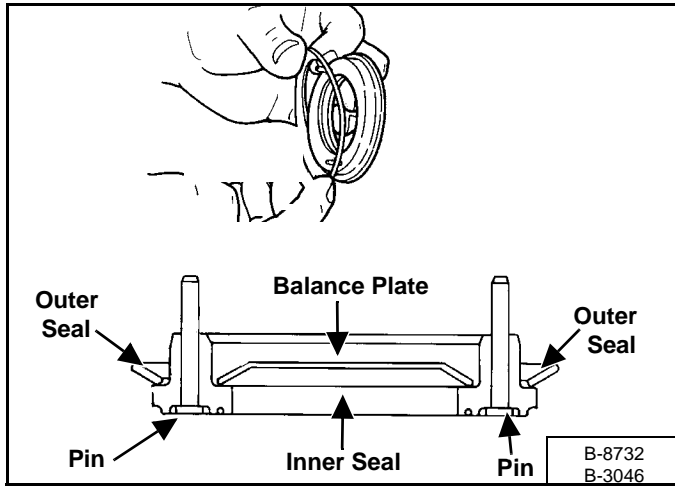

Remove the outer face seal [Figure 30-20-10].

Installation: Put grease on the outer seal during assembly.

Figure 30-20-11

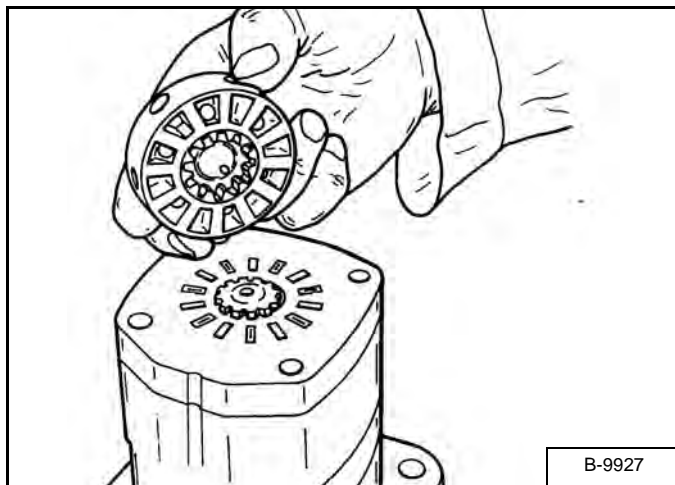

Remove the valve [Figure 30-20-11].

Figure 30-20-12

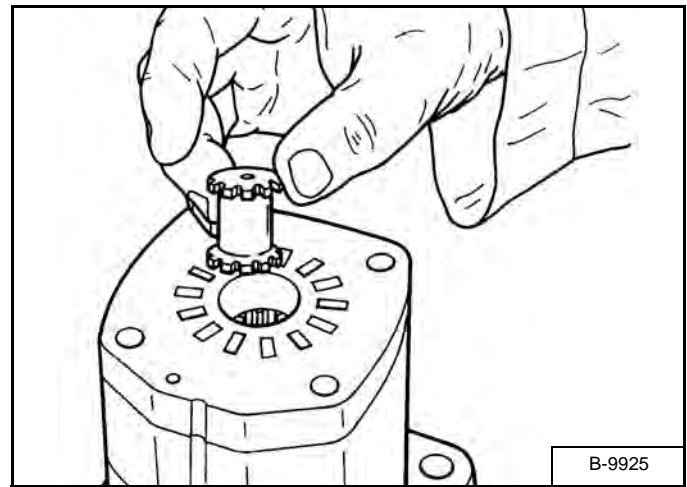

Remove the valve drive [Figure 30-20-12].

Figure 30-20-13

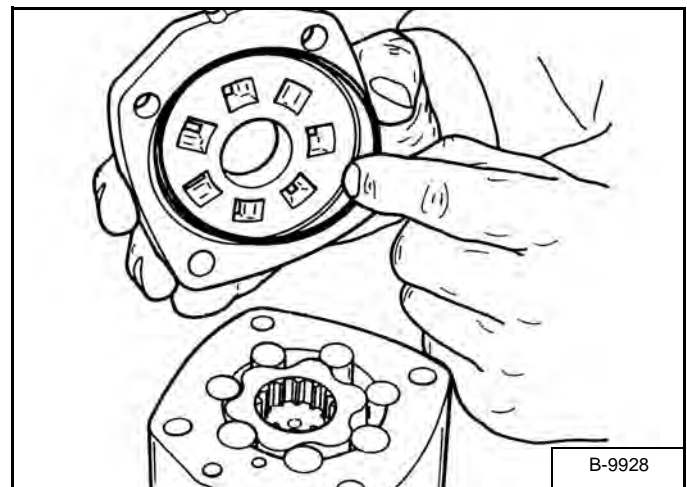

Remove the valve plate [Figure 30-20-13].

Remove the 76 mm (3 in) diameter O-ring from the valve plate [Figure 30-20-13].

HYDROSTATIC DRIVE MOTOR (CONT'D)

Disassembly (Cont'd)

Figure 30-20-14

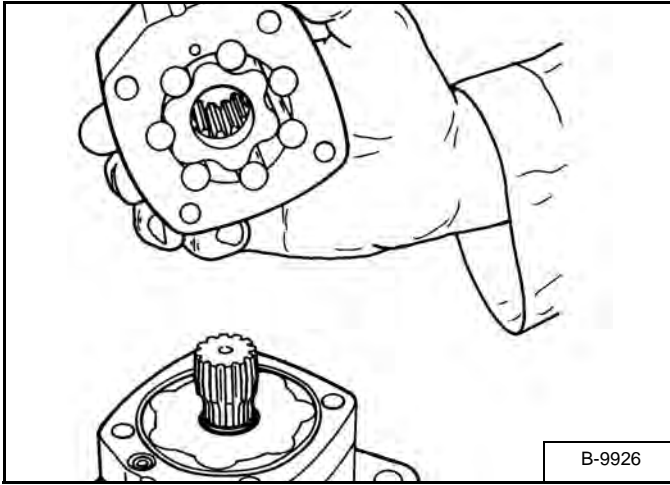

Remove the Geroler® [Figure 30-20-14]. Make sure the rollers are kept in place.

Figure 30-20-15

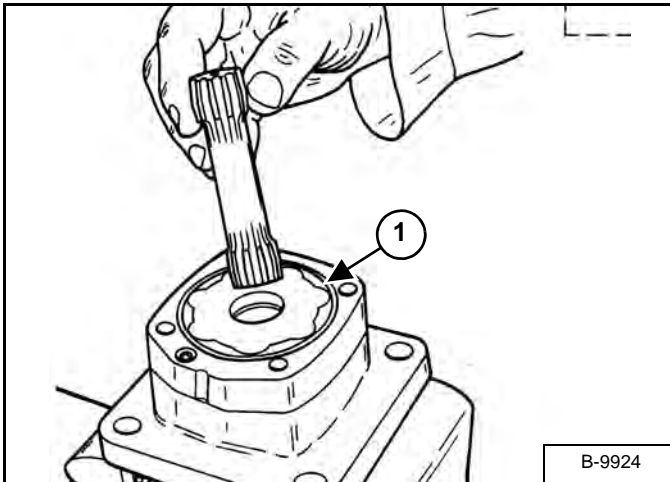

Remove the drive shaft [Figure 30-20-15].

Remove the 76 mm (3 in) diameter O-ring (Item 1) [Figure 30-20-15] from the wear plate.

Figure 30-20-16

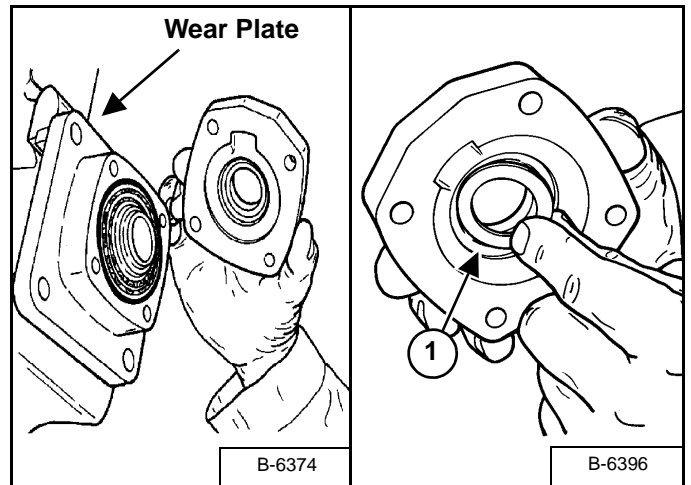

Remove the wear plate [Figure 30-20-16].

Remove the shaft face seal (Item 1) [Figure 30-20-16] from the wear plate.

Remove the 76 mm (3 in) diameter O-ring from the bearing housing.

Figure 30-20-17

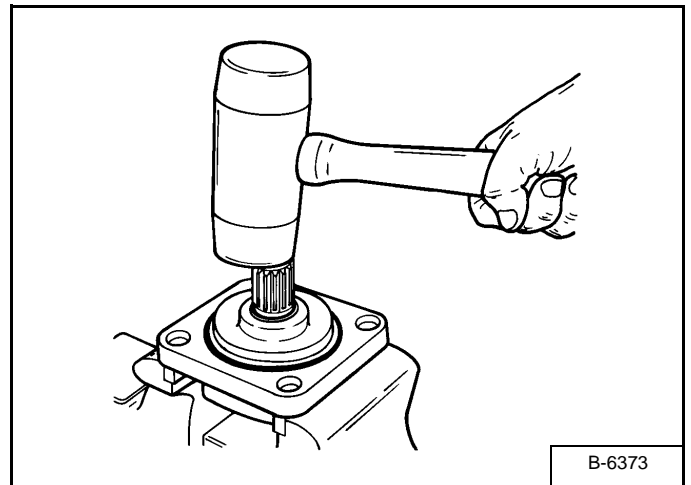

Remove the shaft and bearing assembly from the housing [Figure 30-20-17].

HYDROSTATIC DRIVE MOTOR (CONT'D)

Disassembly (Cont'd)

Figure 30-20-18

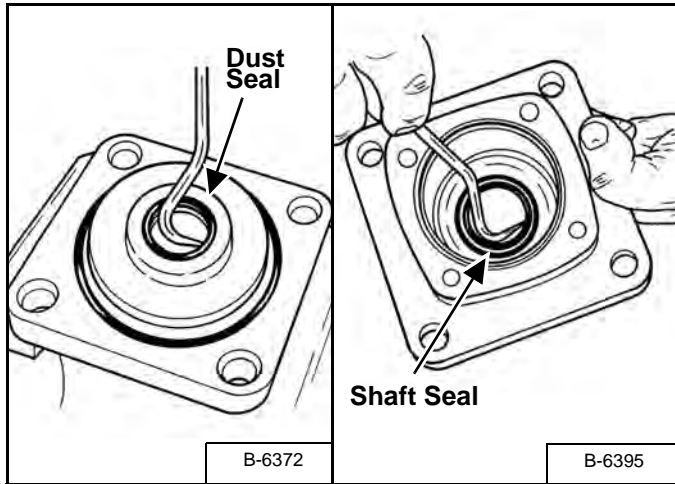

Remove the dust seal from the housing [Figure 30-20-18].

Remove the shaft seal from inside the housing [Figure 30-20-18].

NOTE: The shaft and bearing assembly are not sold as individual parts. Replace as a unit.

Before the motor is assembled, check the following items:

Figure 30-20-19

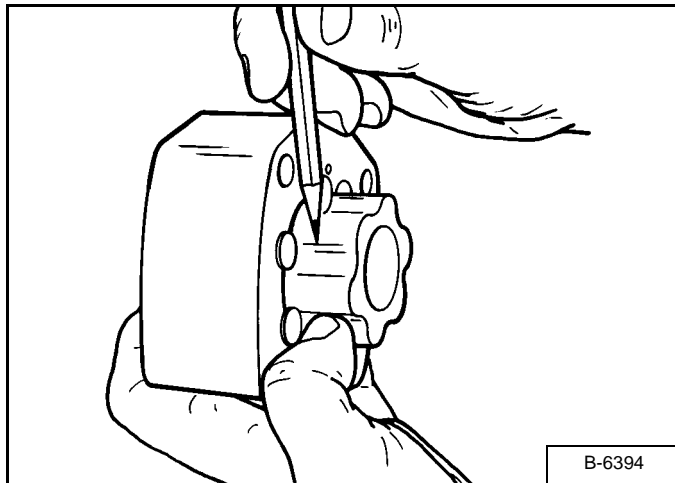

Check the Geroler® for wear or scratches [Figure 30-20-19].

Figure 30-20-20

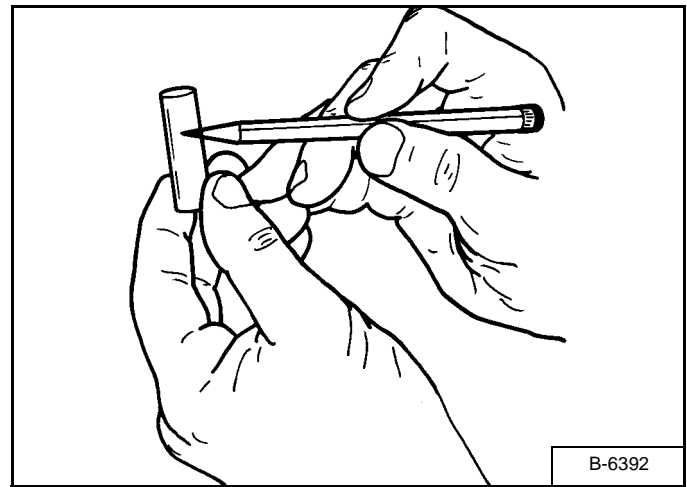

Check the Geroler® rollers [Figure 30-20-20].

Check the rotor.

NOTE: Put all the rollers back in their original position.

Figure 30-20-21

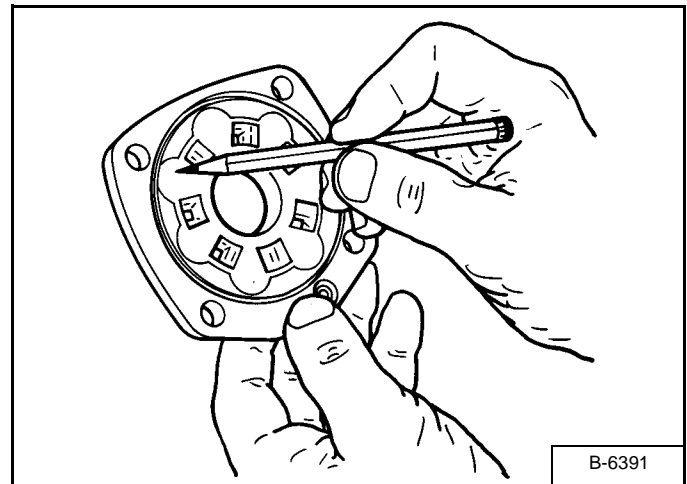

Check the valve plate for wear or scratches [Figure 30-20-21].

HYDROSTATIC DRIVE MOTOR (CONT'D)

Disassembly (Cont'd)

Figure 30-20-22

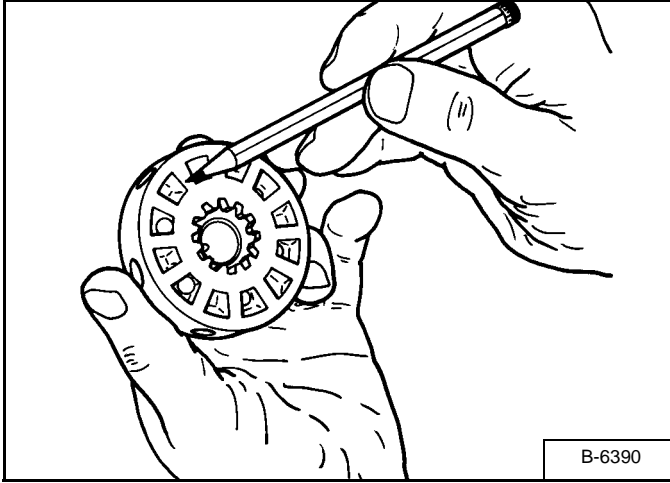

Check the valve [Figure 30-20-22].

Figure 30-20-23

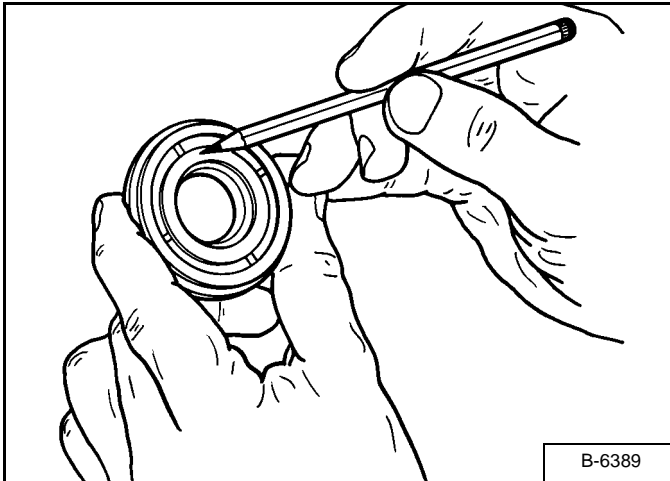

Check the balance plate [Figure 30-20-23].

Check the valve drive shaft and maintenance shaft for wear.

Figure 30-20-24

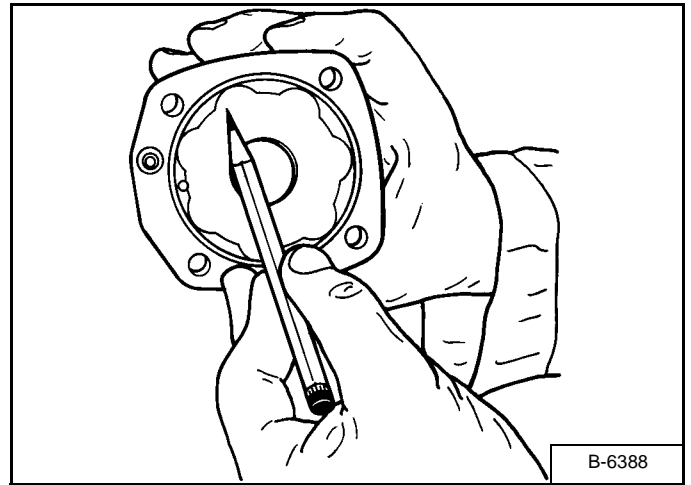

Check the end plate for scratches [Figure 30-20-24].

Check all the contact surfaces. Replace any parts that have scratches or are worn.

Clean all the parts in solvent and use air pressure to dry the parts. DO NOT use cloth or paper because some material may get into the hydrostatic system and cause damage. DO NOT use sandpaper or a file to remove scratches on any of the parts.

HYDROSTATIC DRIVE MOTOR (CONT'D)

Assembly

IMPORTANT

Use grease such as Dow Corning #44 or Vaseline petroleum jelly to hold seals, O-rings and bearings in position during assembly.

I-2010-0597

Figure 30-20-25

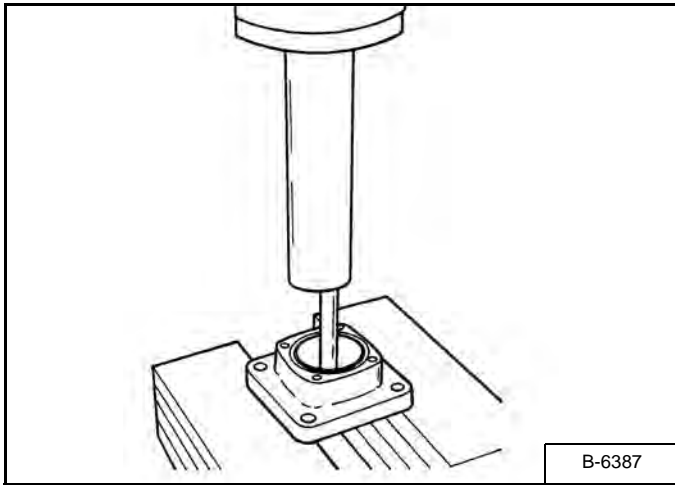
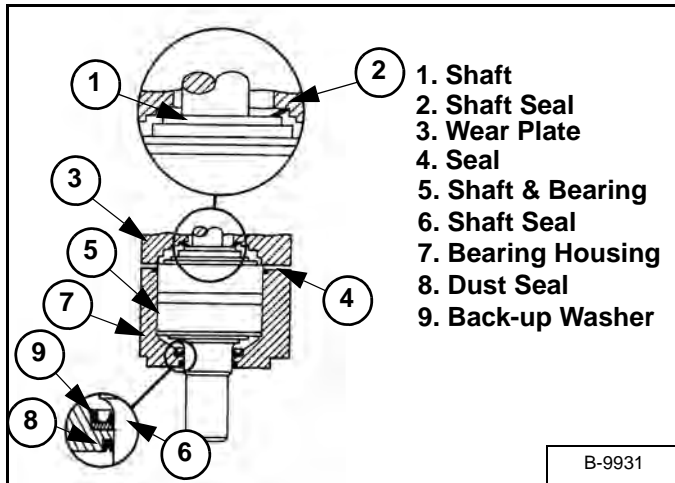

Figure 30-20-26



NOTE: Always use a NEW seal kit when assembling the hydrostatic motor.

Install the back-up washer (Item 9) and use a press to install the shaft seal (Item 2) [Figure 30-20-26] in the bearing housing [Figure 30-20-25].

Figure 30-20-27

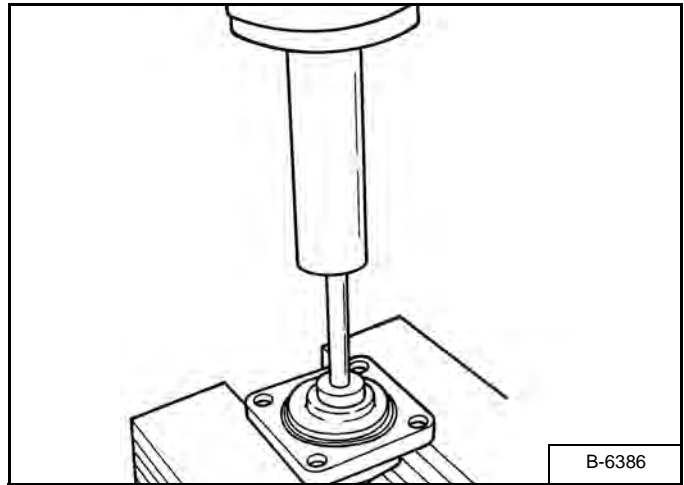

Install the dust seal [Figure 30-20-27] as shown in (Item 8) [Figure 30-20-26].

Figure 30-20-28

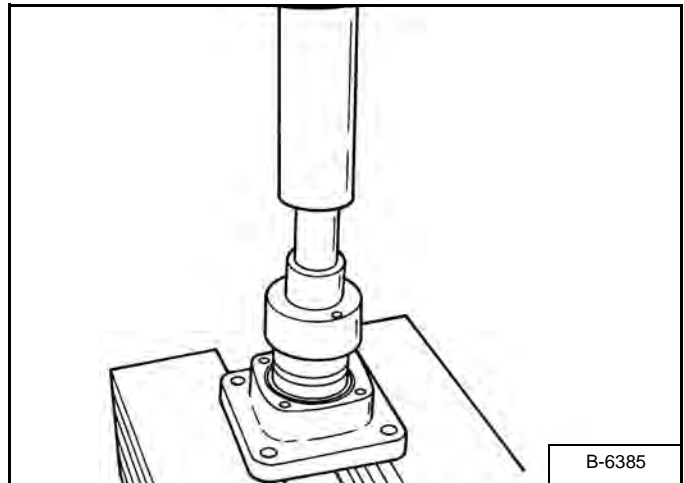

Use a press to install the bearing and shaft assembly in the housing [Figure 30-20-28].

Lubricate and install the 76 mm (3 in) diameter O-ring on the bearing housing.

NOTE: You can use alignment studs for easier assembly of the motor.

HYDROSTATIC DRIVE MOTOR (CONT'D)

Assembly (Cont'd)

Figure 30-20-29

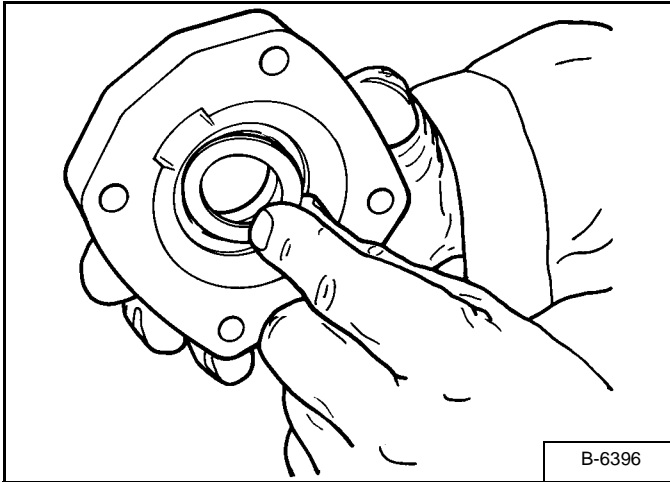

Install the shaft face seal (Item 2) [Figure 30-20-26 on Page 30-20-10] in the wear plate [Figure 30-20-29].

Figure 30-20-30

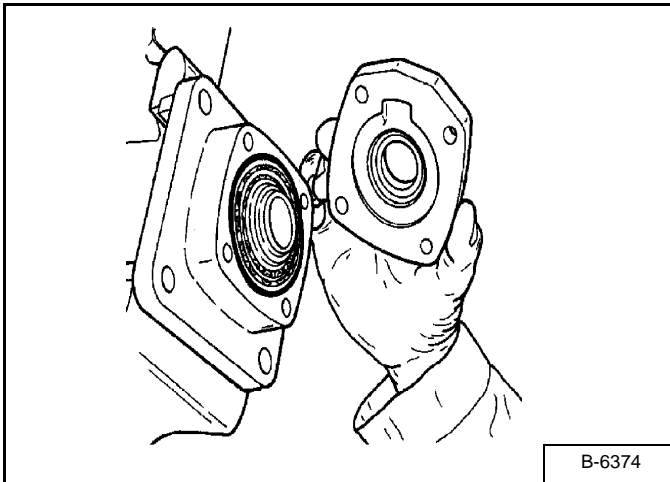

Install the wear plate [Figure 30-20-30].

Figure 30-20-31

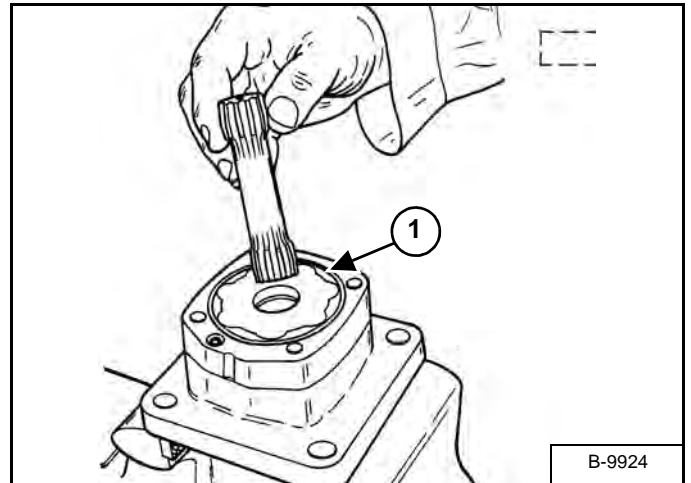

Lubricate the 76 mm (3 in) diameter O-ring (Item 1) [Figure 30-20-31].

Install the drive in the housing [Figure 30-20-31].

Figure 30-20-32

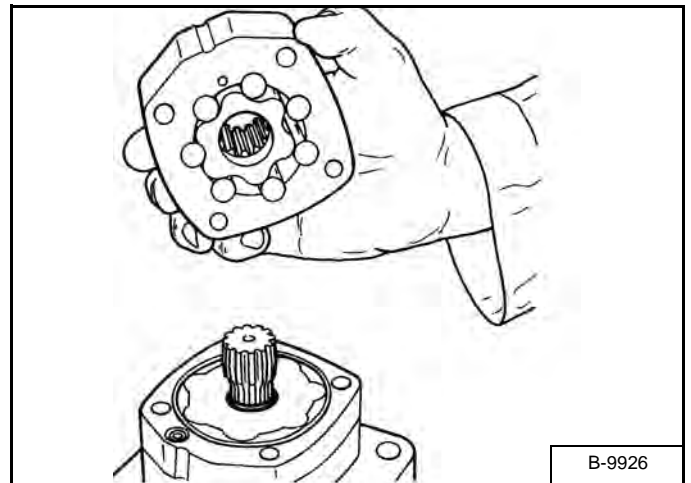

Align the notch on the outside of the Geroler® with the notch on the wear plate. Install the Geroler® against the wear plate. Hold the rollers in the Geroler® while installing it [Figure 30-20-32].

HYDROSTATIC DRIVE MOTOR (CONT'D)

Assembly (Cont'd)

Figure 30-20-33

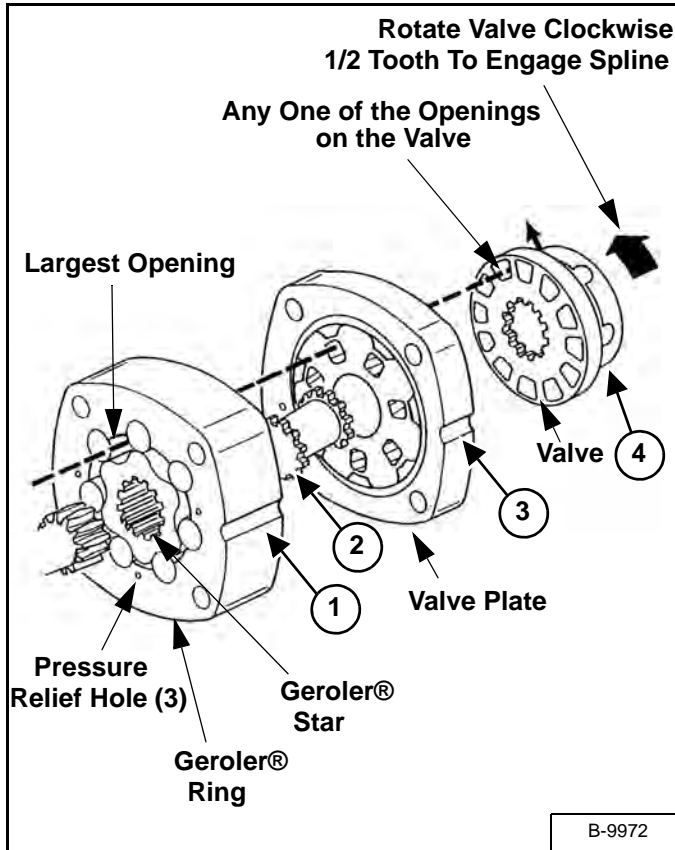

The timing of the motor controls the direction of the rotation of the drive shaft of the motor. The timing parts are as follows [Figure 30-20-33]:

- Geroler® Ring (Item 1)
- Valve Drive (Item 2)
- Valve Plate (Item 3)
- Valve (Item 4)

Find the largest opening between the Geroler® star and the Geroler® ring and mark the outside of the Geroler® ring at the location [Figure 30-20-33].

Install the valve drive in the Geroler® (Item 2) [Figure 30-20-33].

Lubricate the 76 mm (3 in) diameter O-ring and install it on the valve plate.

Align the notch on the outside of the valve plate with the notch on the Geroler® ring [Figure 30-20-33]. Install the valve plate (O-ring side toward the Geroler®) on the Geroler®.

Align the slot opening in the valve plate with the largest opening of the Geroler®.

NOTE: If you can see a roller (in the Geroler®) in all the holes of the valve plate the motor is timed wrong.

Align the valve on the valve plate so that any one of the openings is in alignment with the open slot in the valve plate and the largest opening of the Geroler® [Figure 30-20-33]. Turn the valve CLOCKWISE 1/2 tooth to engage the drive.

Figure 30-20-34

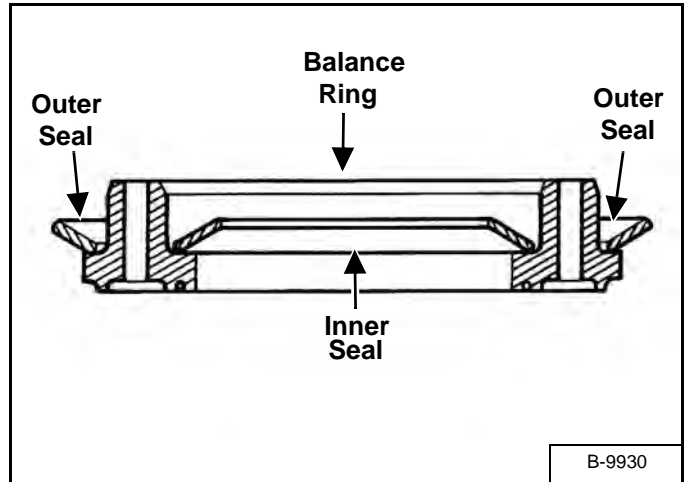

Lubricate the inner and outer seals and install the seals on the balance ring [Figure 30-20-34].

IMPORTANT

Install the seals in the position as shown or the motor will not operate correctly. Do not force or bend the seals. Any damage to these seals will have a direct effect on the motor operation.

I-2098-1295

HYDROSTATIC DRIVE MOTOR (CONT'D)

Assembly (Cont'd)

Figure 30-20-35

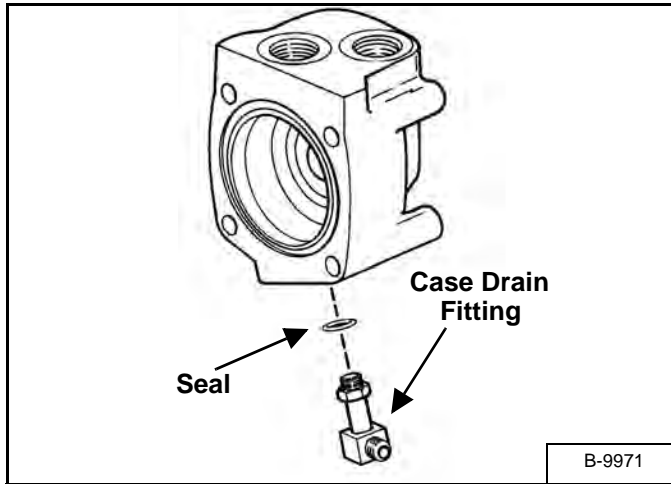

Install the seals and the case drain fitting on the valve housing [Figure 30-20-35].

Figure 30-20-36

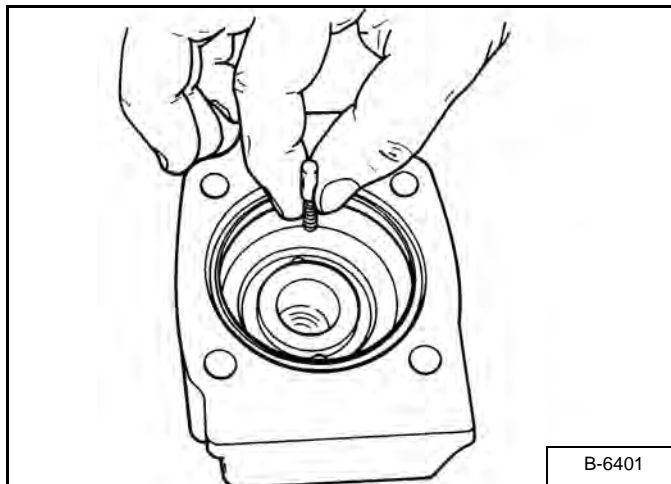

Install the pins and springs in the valve housing [Figure 30-20-36].

Lubricate the 76 mm (3 in) diameter O-ring and install on the valve housing.

Align the pin grooves in the balance ring with the pins in the valve housing. Install the balance ring assembly in the housing.

Figure 30-20-37

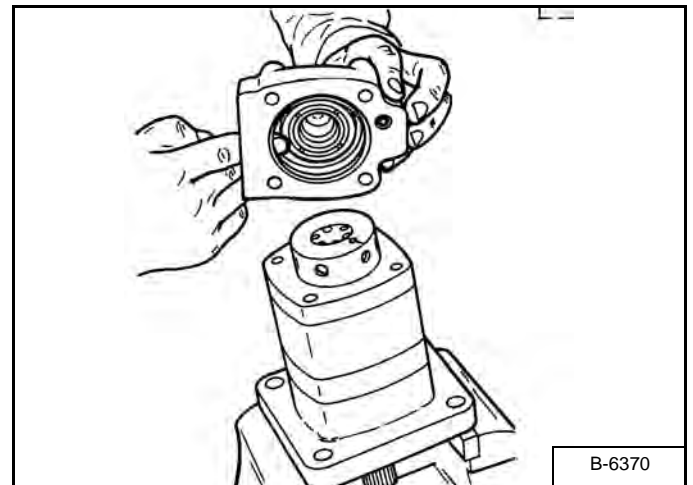

Put your finger through the port in the valve housing to hold the balance ring in position [Figure 30-20-37].

NOTE: You must feel a spring action of the balance ring after the valve housing is installed.



Bobcat®

CHARGE PRESSURE

Description

Charge pressure is a supply of oil to the hydrostatic pumps. Charge pressure is regulated by a charge relief valve located inside the filter housing. Charge pressure is used to replenish hydrostatic fluid removed from the drive circuit, pump and motor “internal leakage” and from the hydrostatic motors shuttle (flushing) valve.

Charge pressure is obtained from the standard section on the hydraulic gear pump.

Charge pressure is also used to operate other hydraulic functions, such as shifting the auxiliary spool in the main hydraulic control valve.

The charge pressure sender is located on the charge filter housing.

Testing



Put jackstands under the front axles and rear corners of the frame before running the engine for service. Failure to use jackstands can allow the machine to fall or move and cause injury or death.

W-2017-0286

Lift and block the loader. (See Procedure on Page 10-10-1.)

Raise the operator cab. (See Raising on Page 10-30-2.)

The tools listed are needed to complete the following procedure:

MEL1173a - Test Kit

Figure 30-30-1

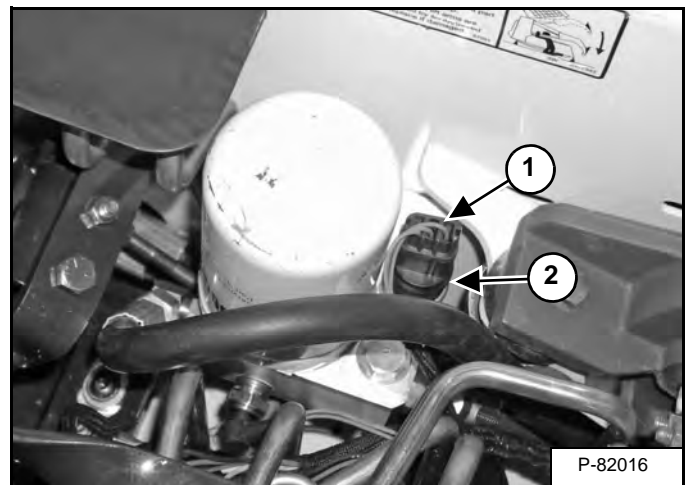

Disconnect the electrical connector (Item 1) from the charge pressure sender (Item 2) **[Figure 30-30-1]**.

Remove the charge pressure sender from the filter port block.

Installation: Tighten the charge pressure sender to 10 - 11 N•m (7.4 - 8.1 ft-lb) torque.

CHARGE PRESSURE (CONT'D)

Testing (Cont'd)

Figure 30-30-2

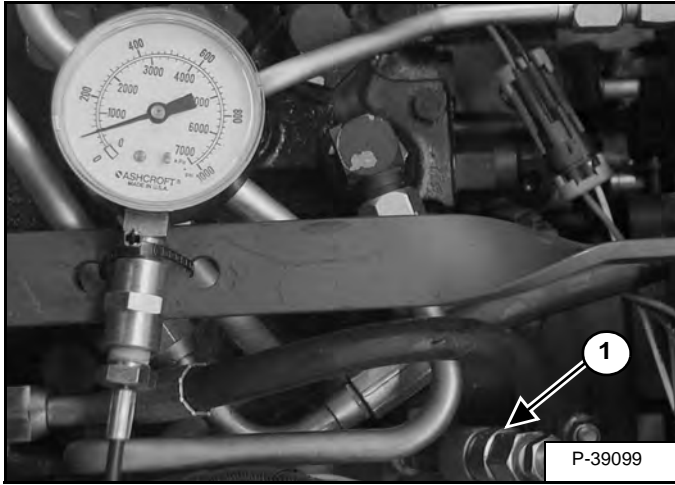

Connect the pressure gauge into the sender port of the filter port block (Item 1) [Figure 30-30-2].

Start the loader and warm the hydraulic fluid to 60°C (140°F).

With the engine at full rpm and no hydraulic action, the minimum pressure must be:

For S/N A3W611001 - A3W613788, S/N A3W711001 - A3W713562: 517 - 586 kPa (5,2 - 6 bar) (75 - 85 psi),

For S/N A3W613789 & Above, S/N A3W713563 & Above, S/N B38V11001 & Above, S/N B38W11001 & Above: 793 - 862 kPa (7,9 - 8,6 bar) (115 - 125 psi).

Stop the engine.

Figure 30-30-3

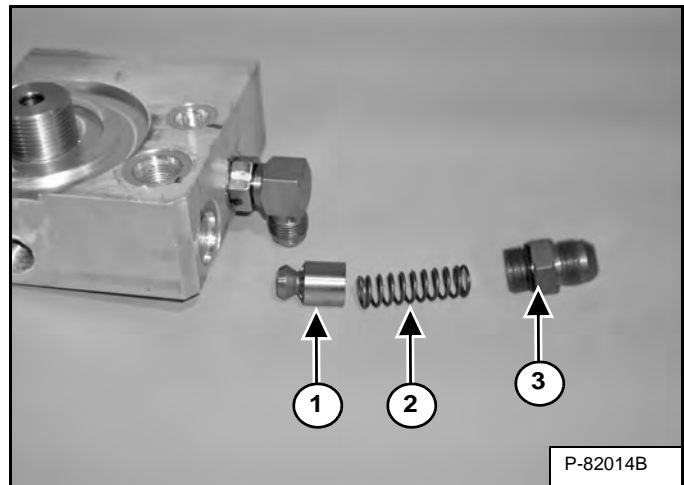

If the charge pressure is not correct, check the charge pressure poppet (Item 1) and spring (Item 2) by removing the fitting (Item 3) [Figure 30-30-3].

NOTE: (Item 3) [Figure 30-30-3] may be a barbed hose fitting on later machines. When replacing, see the Parts Manual for the recommended parts.

CHARGE PRESSURE (CONT'D)

Sender Removal And Installation

Figure 30-30-4

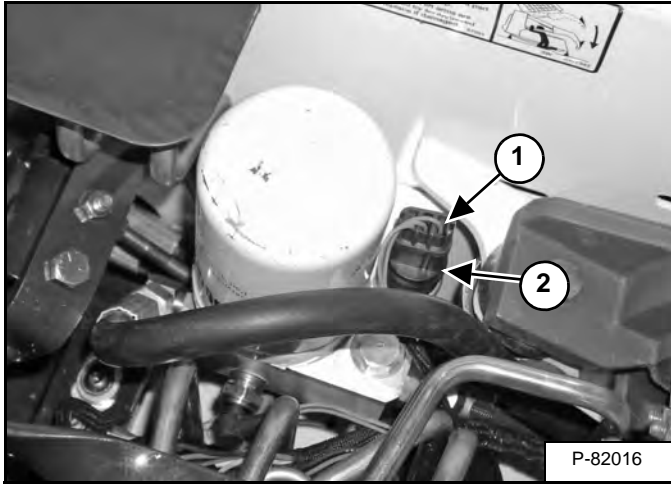

Disconnect the charge pressure sender connector (Item 1) [Figure 30-30-4] from the sender.

Remove the sender (Item 2) [Figure 30-30-4] from the adapter fitting.

Installation: Tighten the charge pressure sender to 10 - 11 N•m (7.4 - 8.1 ft-lb) torque.



Bobcat®

HYDROSTATIC PUMP

Description

The hydrostatic pump is composed of two hydrostatic piston pumps connected together. The pumps provide bi-directional flow to two separate hydrostatic drive motors. The pump flow and direction are controlled by two hand levers, one for each pump.

The hydrostatic pump contains replenishing valves. The function of these valves is to give replacement fluid to the low pressure side of the hydrostatic circuit. Replacement is needed because of normal internal leakage and the controlled flow to the oil cooler for cooling. Another function of the replenishing valve is to keep high pressure fluid out of the low pressure side of the hydrostatic circuit.

The hydrostatic pump is located below the operator's seat and is mounted to the engine flywheel housing.

Replenishing / High Pressure Relief Valve Removal And Installation

Figure 30-40-1

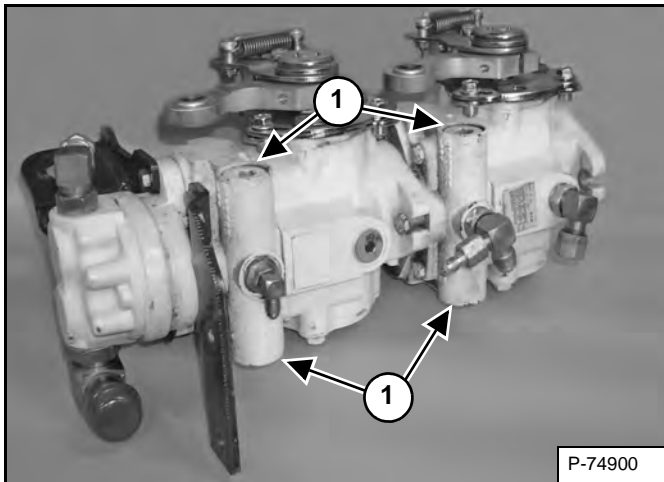

There are four replenishing / high pressure relief valves (Item 1) [Figure 30-40-1] in the hydrostatic pump assembly. Two are located at the top of the pumps and two are located at the bottom of the pumps.

NOTE: The two top valves are for the reverse drive loop and the two bottom valves are for the forward drive loop.

Figure 30-40-2

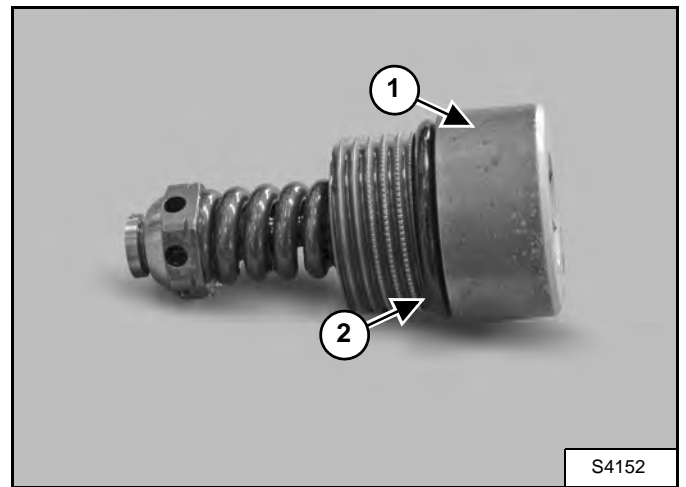

Remove the replenishing / high pressure relief valve (Item 1) [Figure 30-40-2] from the pump.

Assembly: Tighten the plug to 41 - 68 N•m (30 - 50 ft-lb) torque.

Inspect for damage and replace as needed.

Inspect O-ring (Item 2) [Figure 30-40-2] for damage and replace as needed.

If the replenishing / high pressure relief valve must be replaced, it must be replaced as a complete unit.

The pressure setting for a new replenishing / high pressure relief valve is 29303 kPa (293 bar) (4250 psi).

HYDROSTATIC PUMP (CONT'D)

Removal And Installation

IMPORTANT

When repairing hydrostatic and hydraulic systems, clean the work area before disassembly and keep all parts clean. Always use caps and plugs on hoses, tubelines and ports to keep dirt out. Dirt can quickly damage the system.

I-2003-0888

Remove the engine / hydrostatic pump assembly from the loader. (See Engine Removal And Installation on Page 70-10-9.)

Figure 30-40-3

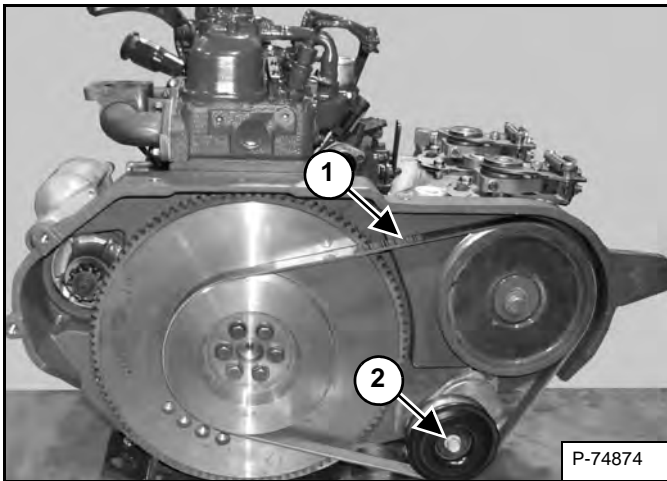

Loosen the drive belt (Item 1) by pulling the tension pulley (Item 2) [Figure 30-40-3] upwards with a socket wrench.

Remove the drive belt by pulling it back from the pulleys.

Figure 30-40-4

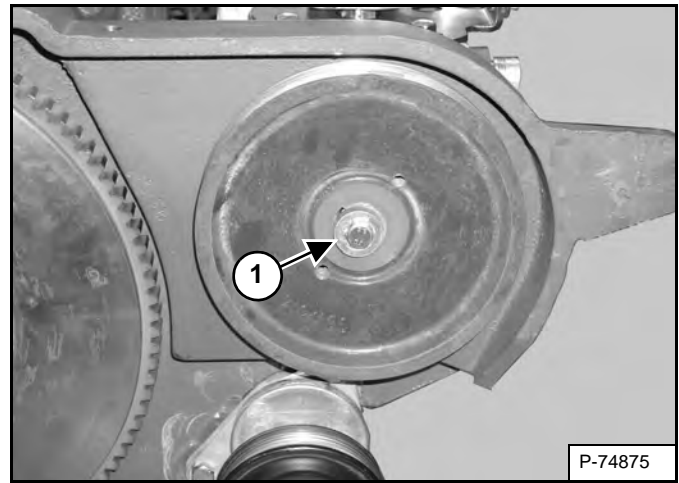

Remove the bolt and washer (Item 1) [Figure 30-40-4].

Installation: Tighten to 47 - 54 N•m (35 - 40 ft-lb) torque.

Figure 30-40-5

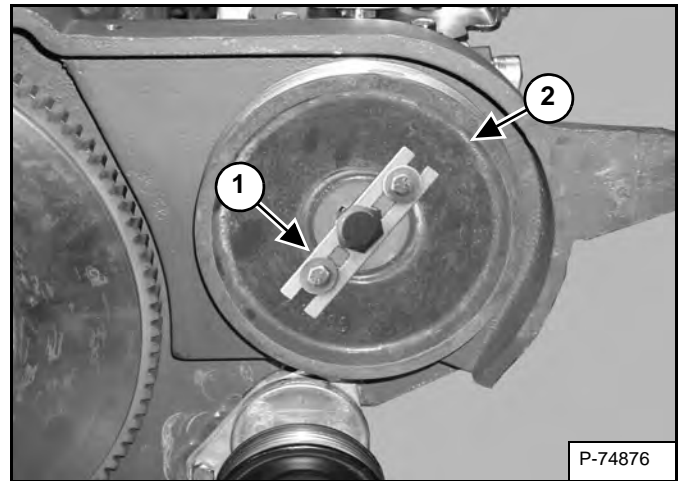

Install the puller (Item 1) on the hydrostatic pump drive pulley. Remove the drive pulley (Item 2) [Figure 30-40-5] from the pump shaft.

Installation: Install the key in the hydrostatic pump shaft before installing the pump drive pulley.

HYDROSTATIC PUMP (CONT'D)

Removal And Installation (Cont'd)

Figure 30-40-6

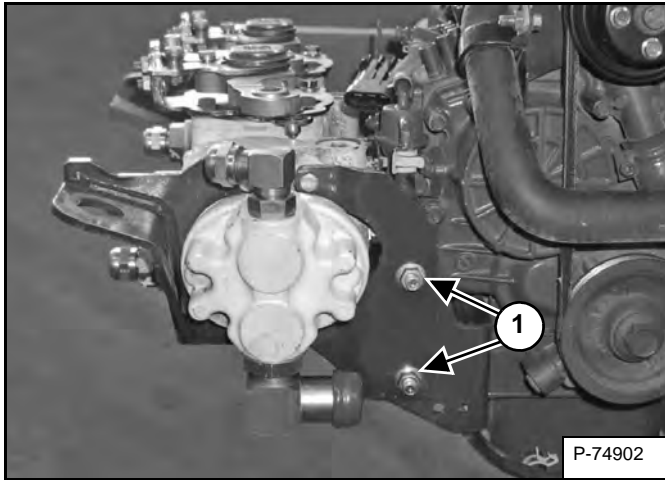

Remove the two bolts (Item 1) [Figure 30-40-6] securing the pump mounting bracket.

Figure 30-40-7

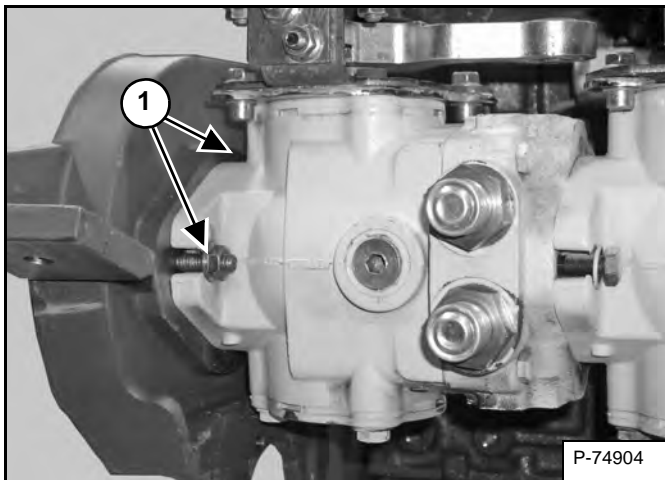

Remove the two hydrostatic pump mounting bolts (Item 1) [Figure 30-40-7] from the pump and drive belt housing. The pump assembly (one hydraulic and two hydrostatic) is now loose from the drive belt housing.

Remove the pintle arms from the hydrostatic pump. (See Pintle Arm Removal on Page 50-100-5.)

Figure 30-40-8

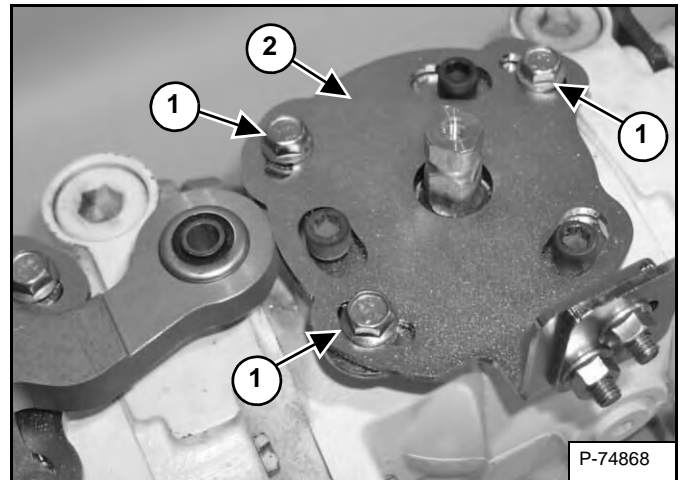

Remove the three bolts (Item 1) and remove the control plate (Item 2) [Figure 30-40-8].

Figure 30-40-9

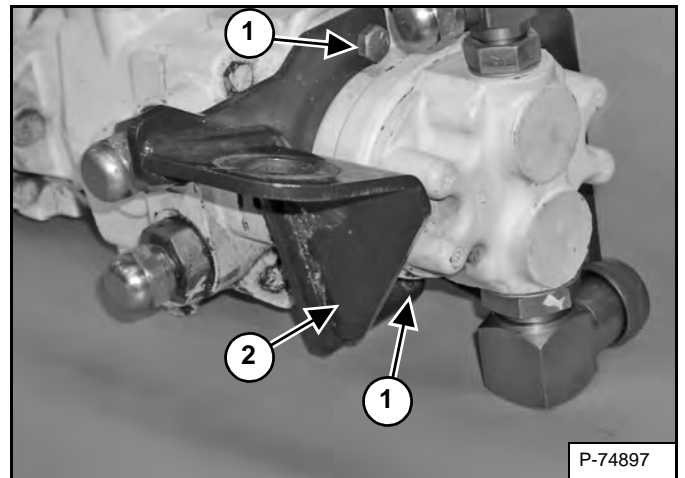

Remove the two mounting bolts (Item 1) and remove the bracket (Item 2) [Figure 30-40-9].

Installation: Tighten to 34 - 38 N•m (25 - 28 ft-lb) torque.

HYDROSTATIC PUMP (CONT'D)

Removal And Installation (Cont'd)

Figure 30-40-10

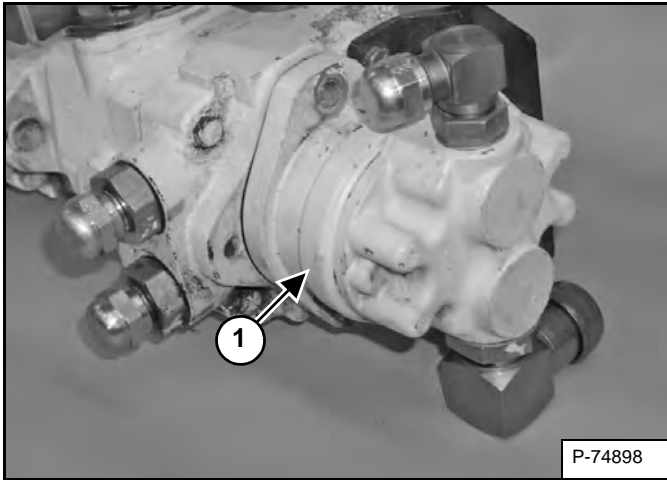

Remove the hydraulic pump (Item 1) [Figure 30-40-10] from the pump assembly.

Figure 30-40-11

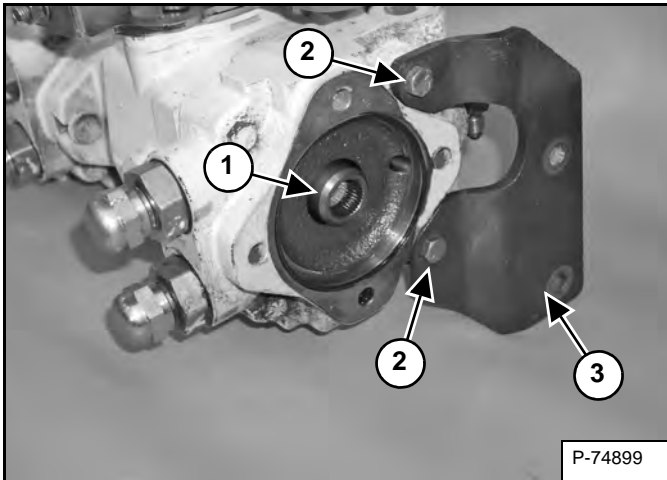

Remove the coupler (Item 1) [Figure 30-40-11].

Remove the two bolts (Item 2) then remove the bracket (Item 3) [Figure 30-40-11].

Installation: Tighten to 34 - 38 N•m (25 - 28 ft-lb) torque.

Figure 30-40-12

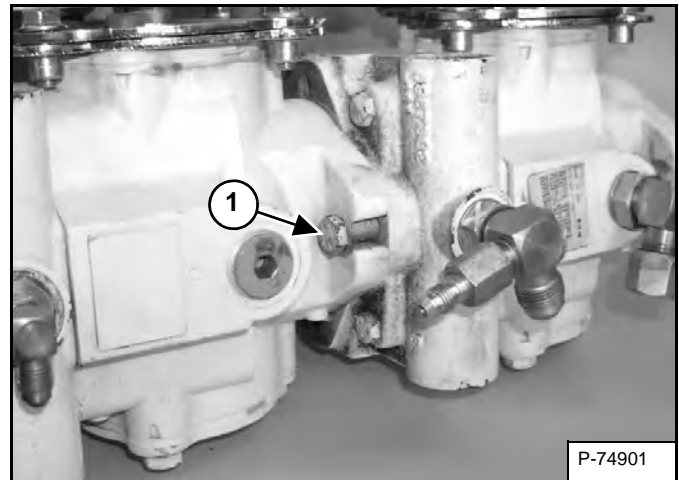

Separate the two hydrostatic pumps by removing the two bolts (Item 1) [Figure 30-40-12].

Installation: Tighten to 37 - 42 N•m (27 - 31 ft-lb) torque.

WARNING

AVOID INJURY OR DEATH

Always clean up spilled fuel or oil. Keep heat, flames, sparks or lighted tobacco away from fuel and oil. Failure to use care around combustibles can cause explosion or fire.

W-2103-0508

HYDROSTATIC PUMP (CONT'D)

Parts Identification

1. Bolt
2. Washer
3. O-ring
4. Coupler
5. Replenishing / High Pressure Relief Valve
6. Plug
7. End Cap
8. Pin
9. Bearing
10. Valve Plate
11. Gasket
12. Cover
13. Bearing Race
14. Tapered Roller Bearing
15. Cylinder Block
16. Wear Plate
17. Swash Plate
18. Housing
19. Crush Ring
20. Seal
21. Shaft (For Right Pump)
22. Shaft (For Left Pump)
23. Key
24. Retainer Ring
25. Bearing Thrust
26. Bearing
27. Washer

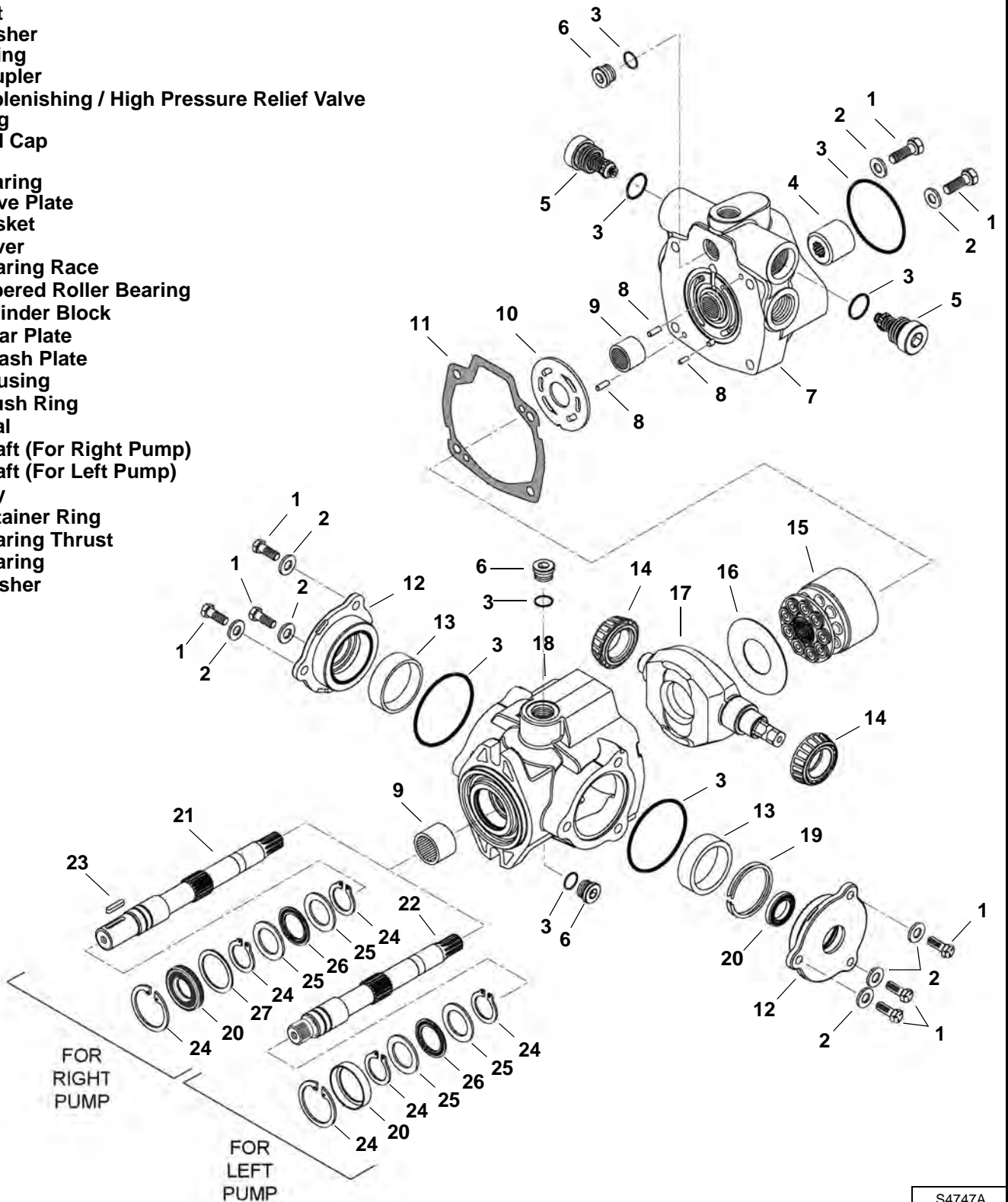

S4747A

HYDROSTATIC PUMP (CONT'D)

Disassembly

Figure 30-40-13

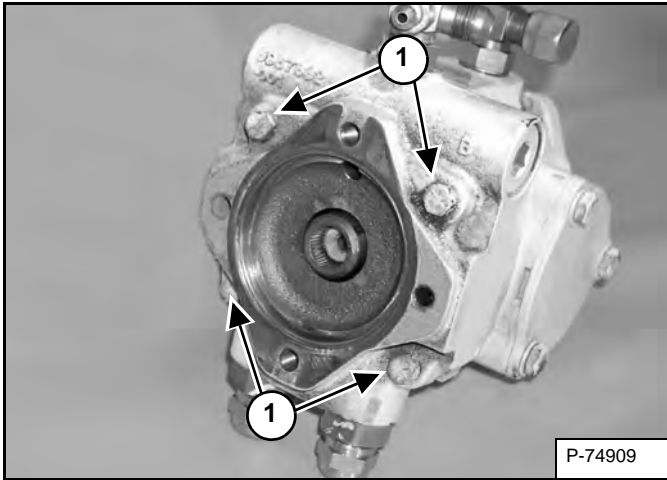

Remove the four bolts (Item 1) [Figure 30-40-13] and remove the pump end cap.

Figure 30-40-14

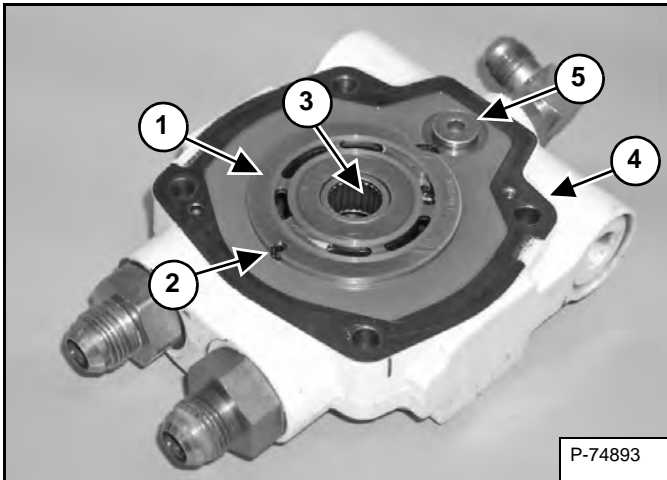

Remove the valve plate (Item 1) [Figure 30-40-14] and gasket from the pump end cap. Check the valve plate for wear (both sides).

Inspect the valve plate locating pin (Item 2) [Figure 30-40-14] for wear and replace if needed.

Inspect the needle bearing (Item 3) [Figure 30-40-14] for wear and replace if needed.

Remove the gasket (Item 4) and plug (Item 5) [Figure 30-40-14].

Figure 30-40-15

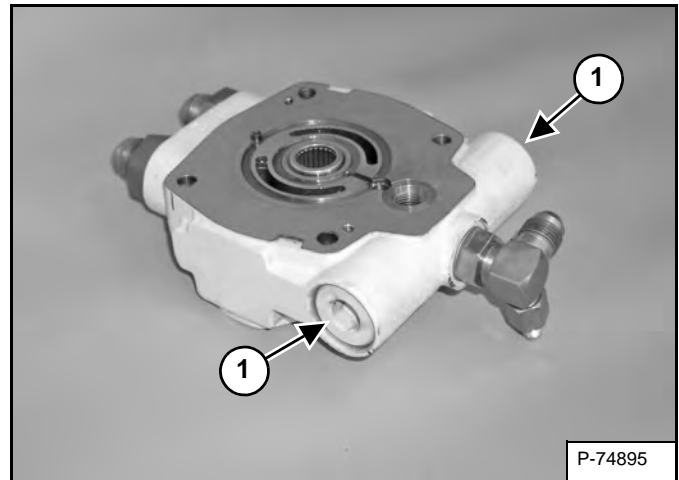

Screw the two replenishing / high pressure valves (Item 1) [Figure 30-40-15] out of the pump end cap.

NOTE: While removing the valves, oil can be spilled.

Figure 30-40-16

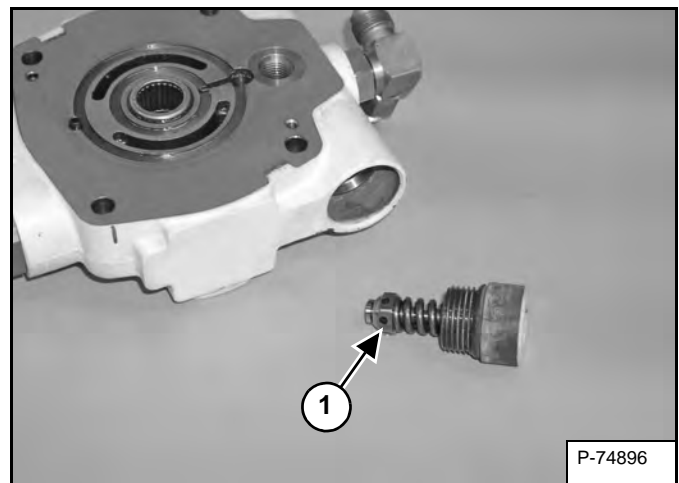

Inspect the condition of the replenishing / high pressure valves (Item 1) [Figure 30-40-16] and replace if needed.

HYDROSTATIC PUMP (CONT'D)

Disassembly (Cont'd)

Figure 30-40-17

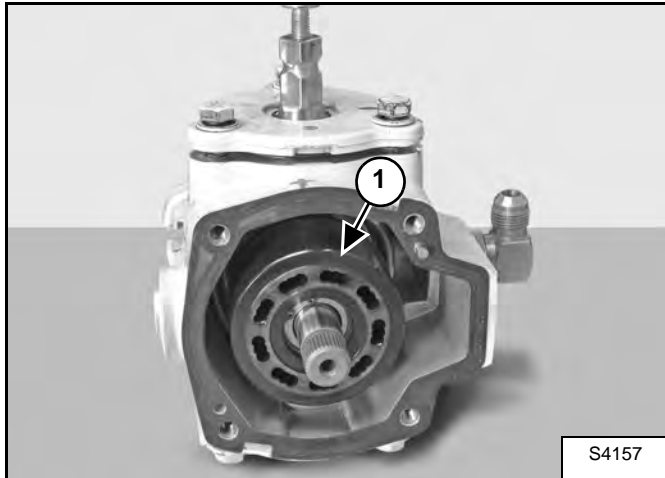

Remove the block and piston assembly (Item 1) [Figure 30-40-17] from the pump by pulling it back.

Figure 30-40-18

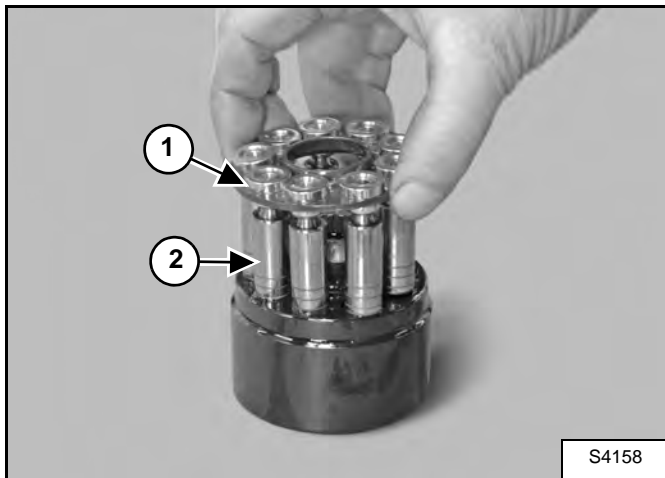

Pull the ring (Item 1) and pistons (Item 2) [Figure 30-40-18] out of the cylinder block.

Inspect all the pistons for wear and replace if needed.

Figure 30-40-19

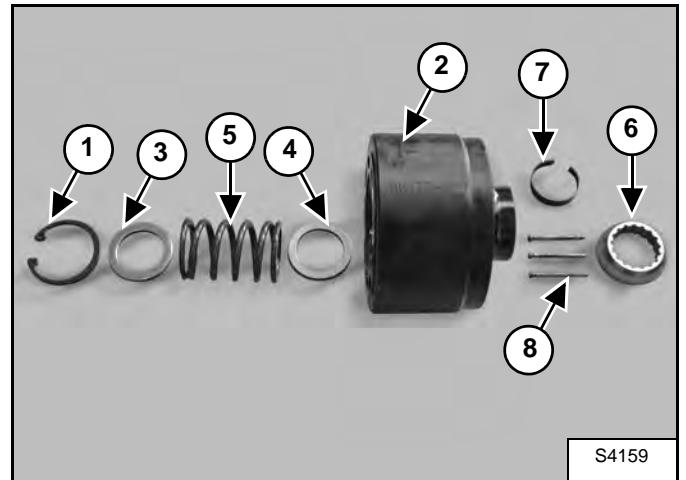

Pull the retaining ring (Item 1) out of the cylinder block (Item 2) [Figure 30-40-19].

NOTE: Remove the retaining ring carefully because of the expanding spring.

Pull the two washers (Items 3 and 4) and the spring (Item 5) [Figure 30-40-19] out of the cylinder block.

Remove the ball guide retainer (Item 6) [Figure 30-40-19] from the cylinder block.

Inspect the ball guide retainer for wear and replace if needed.

Pull the retainer (Item 7) out of the cylinder block and remove the three pins (Item 8) [Figure 30-40-19].

Inspect the cylinder block for wear and replace if needed.

Inspect the three pins to see if they are all the same length.

HYDROSTATIC PUMP (CONT'D)

Disassembly (Cont'd)

Figure 30-40-20

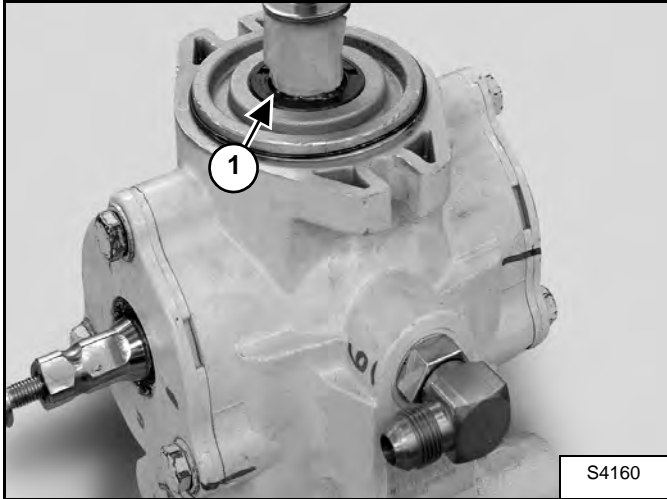

Remove the retaining ring (Item 1) [Figure 30-40-20] from the back of the pump to remove the pump shaft from the pump housing.

Figure 30-40-21

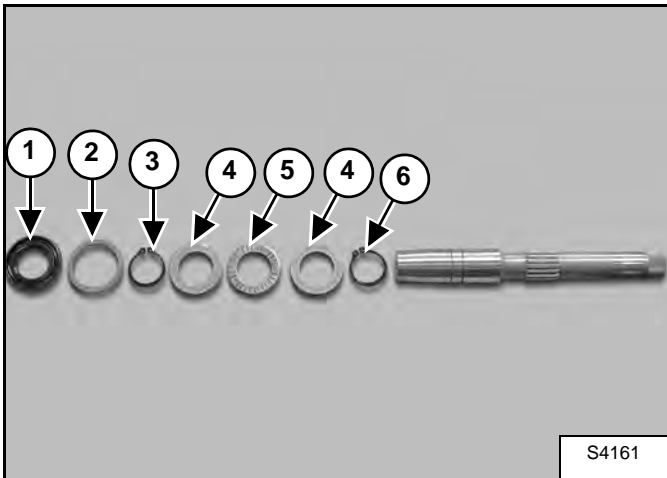

Remove the seal ring (Item 1) and the washer (Item 2) [Figure 30-40-21] from the pump shaft.

Remove the retaining ring (Item 3) [Figure 30-40-21] from the pump shaft.

Remove the two bearing thrusts (Items 4) and the bearing (Item 5) from the pump shaft. Also remove the retaining ring (Item 6) [Figure 30-40-21].

Figure 30-40-22

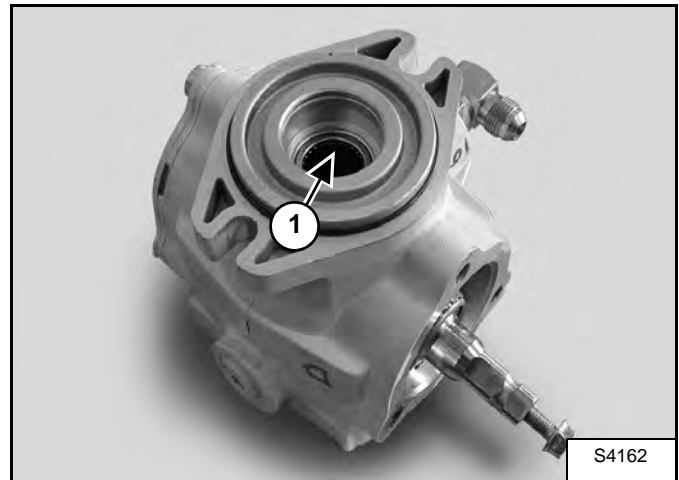

Remove the bearing (Item 1) [Figure 30-40-22] from the pump housing.

Figure 30-40-23

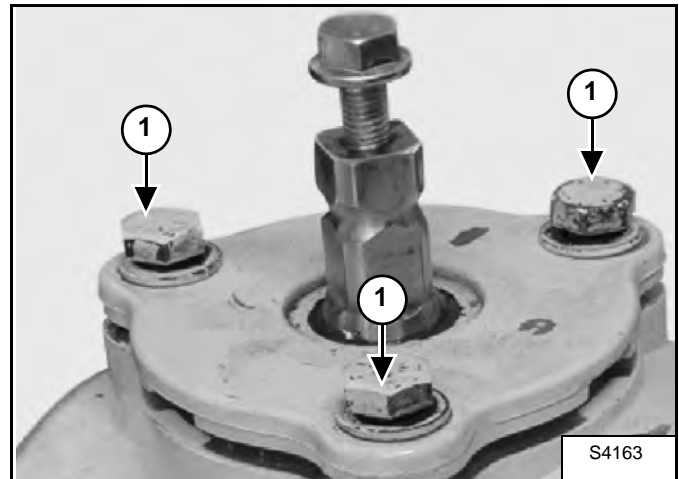

Remove the cover from the pump housing by removing the three bolts (Item 1) [Figure 30-40-23].

HYDROSTATIC PUMP (CONT'D)

Disassembly (Cont'd)

Figure 30-40-24

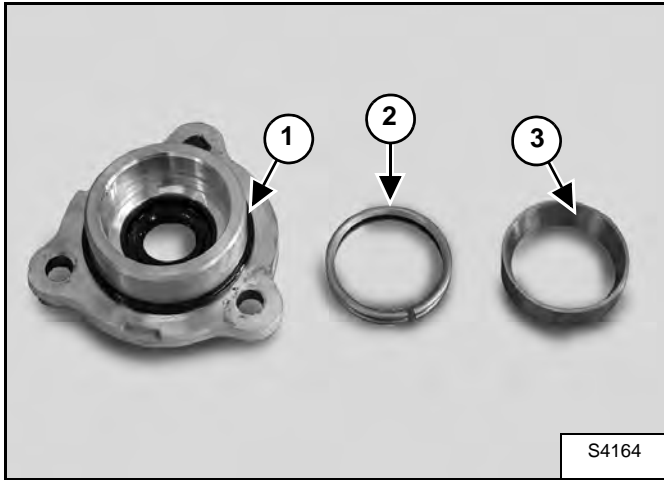

Remove the O-ring (Item 1), the crush ring (Item 2) and the bearing race (Item 3) [Figure 30-40-24] from the cover. Inspect them and replace if needed.

Figure 30-40-25

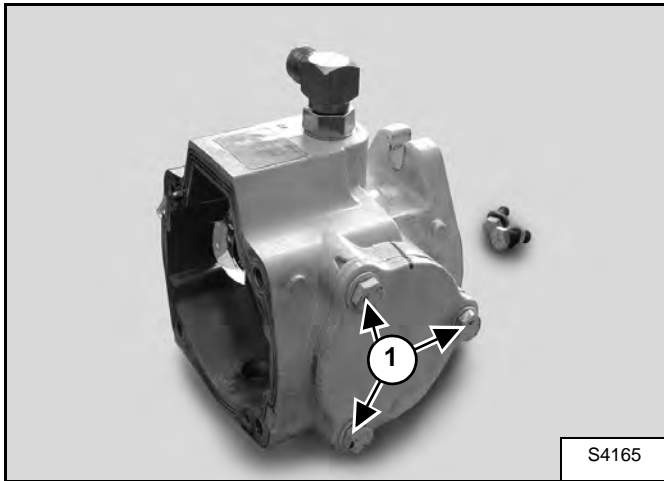

Remove the lower cover from the pump housing by removing the three bolts (Item 1) [Figure 30-40-25].

Figure 30-40-26

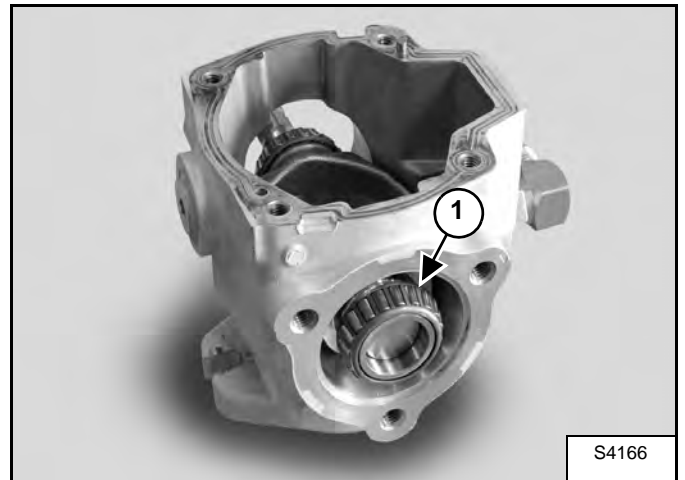

Slide the swash plate from side to side and remove the lower tapered roller bearing (Item 1) [Figure 30-40-26] from the swash plate shaft.

Figure 30-40-27

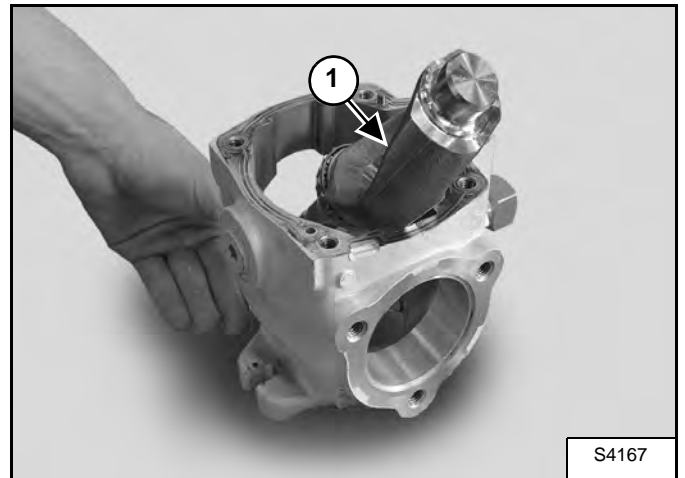

Tilt the swash plate (Item 1) [Figure 30-40-27] and remove the swash plate with upper tapered roller bearing from the pump housing.

HYDROSTATIC PUMP (CONT'D)

Disassembly (Cont'd)

Figure 30-40-28

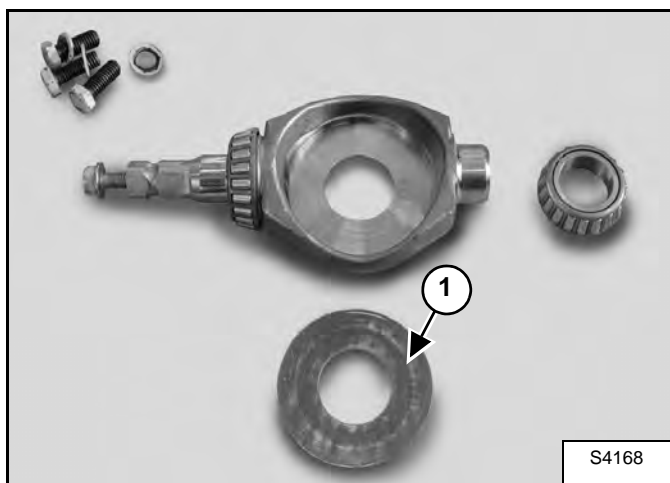

Remove the wear plate (Item 1) [Figure 30-40-28] from the swash plate.

HYDROSTATIC PUMP (CONT'D)

Assembly

Figure 30-40-29

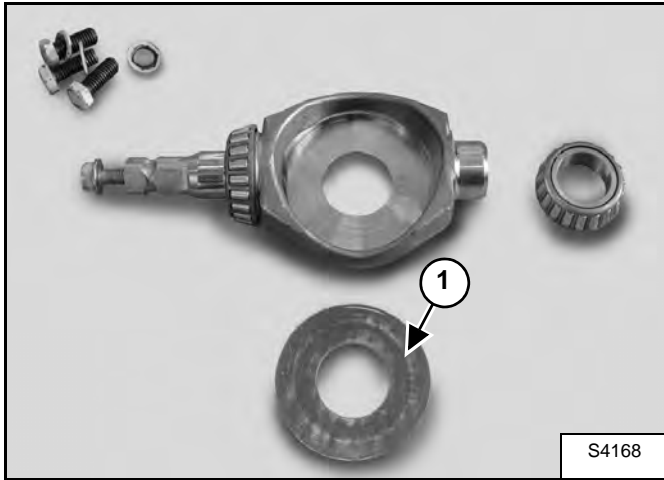

Install the wear plate (Item 1) [Figure 30-40-29] onto the swash plate.

Figure 30-40-30

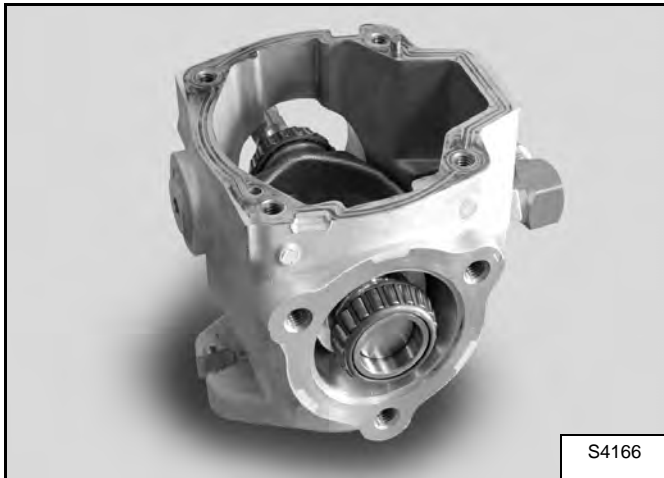

Install the swash plate and the upper tapered roller bearing into the pump housing [Figure 30-40-30].

Figure 30-40-31

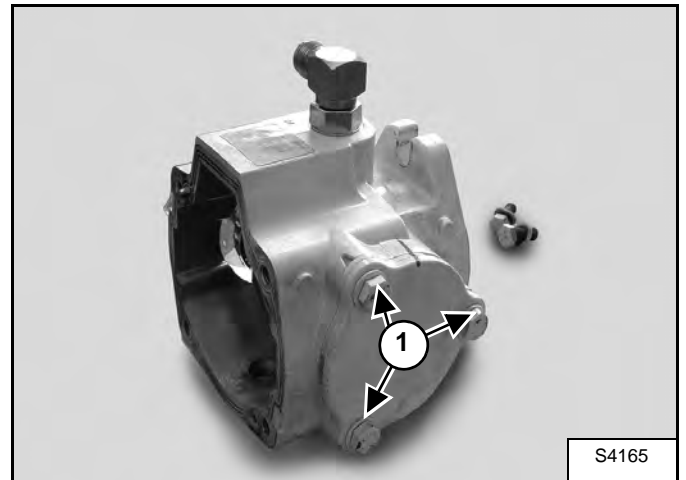

Install the lower cover on the pump housing and tighten the bolts (Item 1) [Figure 30-40-31] to 39,3 N•m (29 ft-lb).

Figure 30-40-32

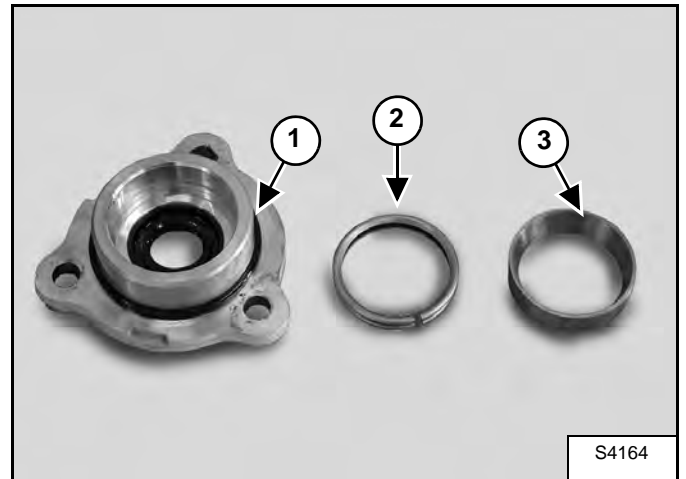

Install the O-ring (Item 1), the crush ring (Item 2) and the bearing race (Item 3) [Figure 30-40-32] on the cover.

HYDROSTATIC PUMP (CONT'D)

Assembly (Cont'd)

Figure 30-40-33

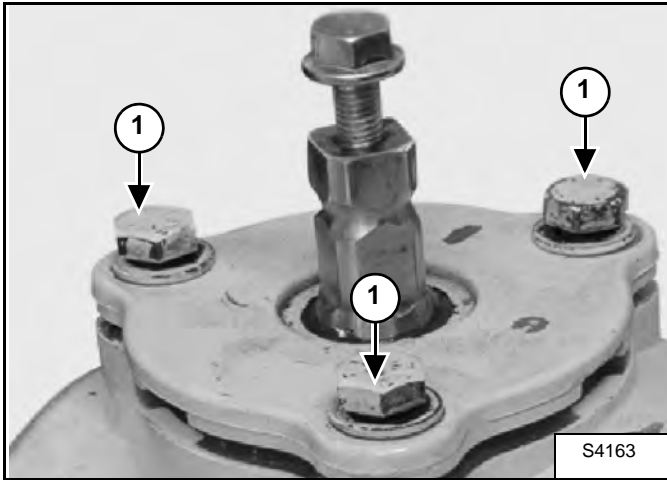

Install the cover on the pump housing and tighten the bolts (Item 1) [Figure 30-40-33] to 39,3 N•m (29 ft-lb).

Figure 30-40-34

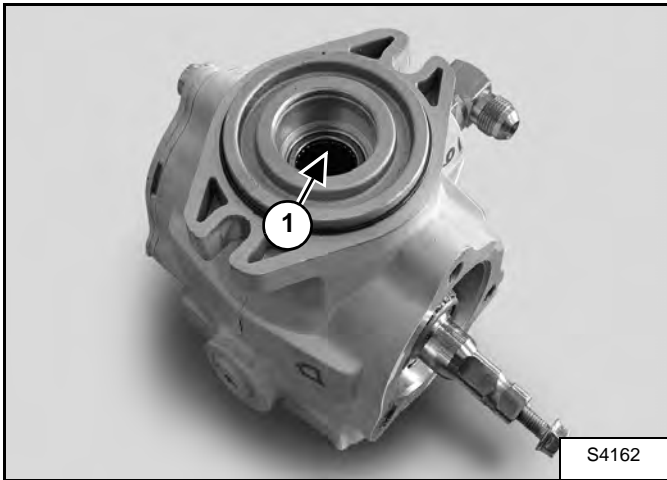

Install the bearing (Item 1) [Figure 30-40-34] into the pump housing.

Figure 30-40-35

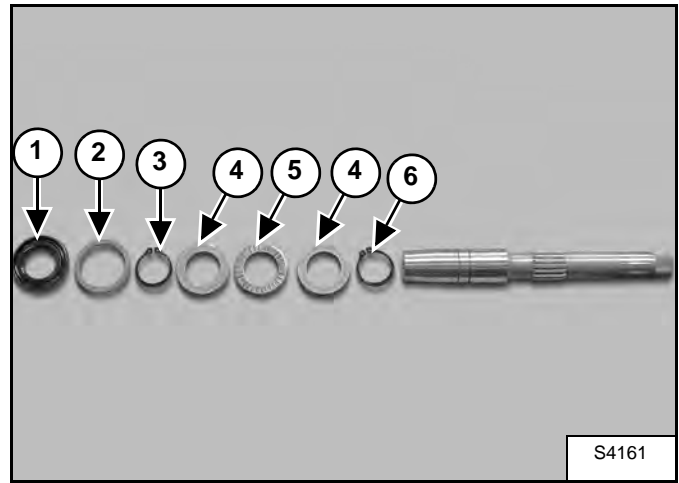

Install the retaining ring (Item 1), the two metal rings (Item 4) and the bearing (Item 5) [Figure 30-40-35] onto the pump shaft.

Install the retaining ring (Item 3) [Figure 30-40-35] onto the pump shaft.

Install the big metal ring (Item 2) and the seal ring (Item 6) [Figure 30-40-35] onto the pump shaft.

Figure 30-40-36

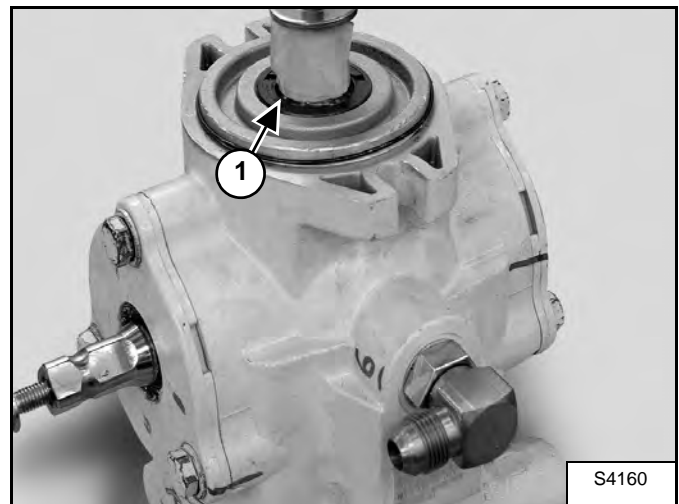

Install the pump shaft into the pump housing and install the retaining ring (Item 1) [Figure 30-40-36].

HYDROSTATIC PUMP (CONT'D)

Assembly (Cont'd)

Figure 30-40-37

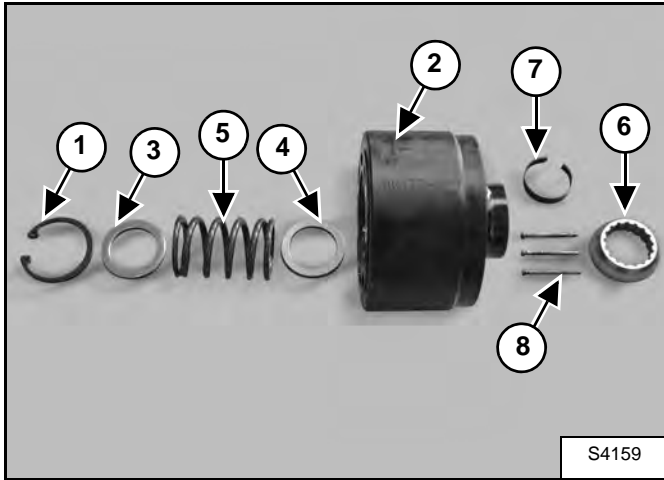

Install the two rings (Items 3 and 4) and the spring (Item 5) [Figure 30-40-37] into the cylinder block.

Install the retaining ring (Item 1) [Figure 30-40-37] into the cylinder block.

Install the three pins (Item 8) into the cylinder block (Item 2) and put the tension ring (Item 7) [Figure 30-40-37] in its place.

Install the ball guide retainer (Item 6) [Figure 30-40-37] into the cylinder block (Item 2).

Figure 30-40-38



Install the ring and pistons into the cylinder block [Figure 30-40-38].

Figure 30-40-39

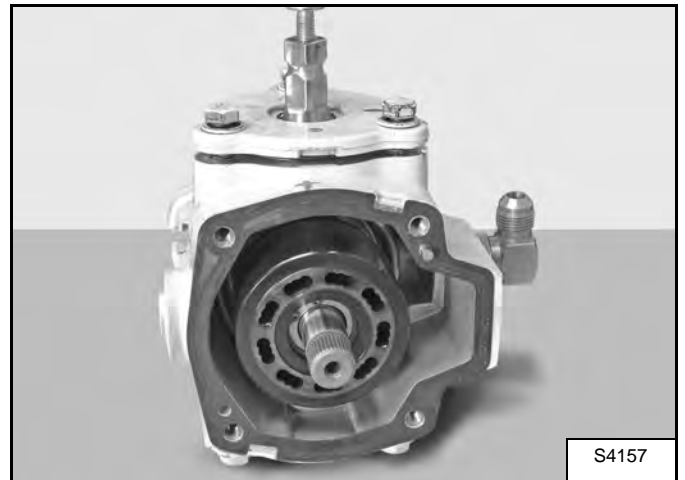

Install the rotating group into the pump as shown in [Figure 30-40-39].

Figure 30-40-40

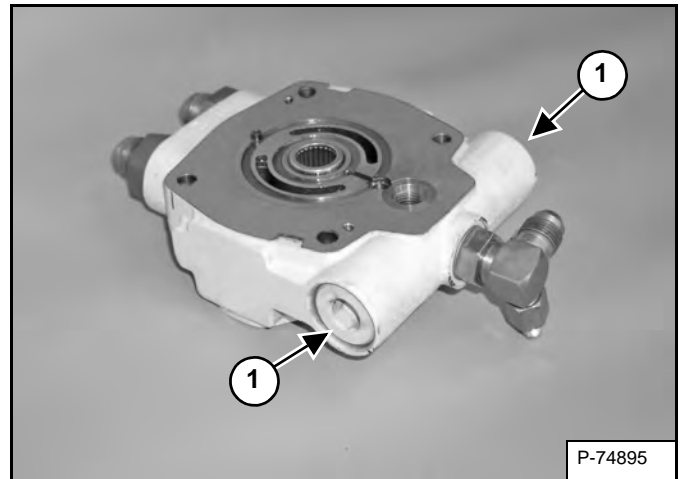

Install the two valves (Item 1) [Figure 30-40-40] into the end cap and tighten to 128,8 - 142,4 N•m (95 - 105 ft-lb).

HYDROSTATIC PUMP (CONT'D)

Assembly (Cont'd)

Figure 30-40-41

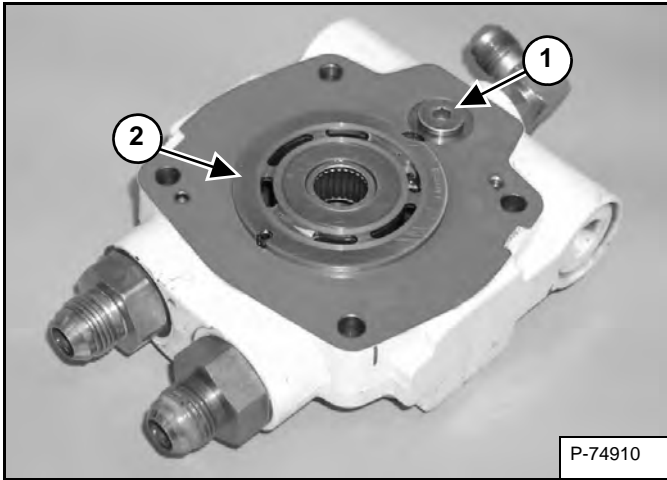

Install the plug (Item 1) [Figure 30-40-41] and tighten.

Coat the backside of the valve plate (Item 2) [Figure 30-40-41] with petroleum jelly to hold it in position and install the valve plate onto the end cap.

Figure 30-40-42

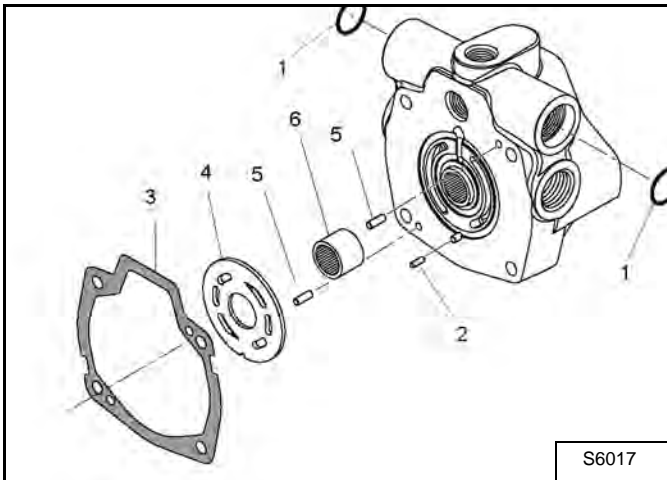

Install the two pins (Items 5) and gasket (Item 3) [Figure 30-40-42] onto the pump part.

Figure 30-40-43

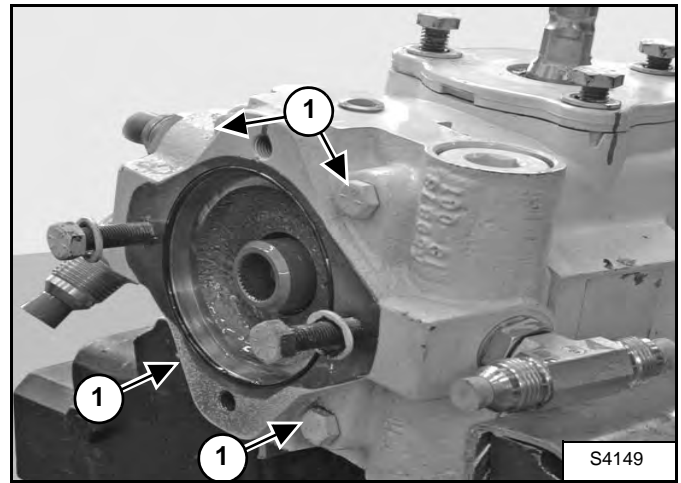

Assemble the two pump parts by means of the four bolts (Item 1) [Figure 30-40-43].

Tighten the bolts to torque.

DRIVE BELT

Description

The drive belt makes the mechanical connection from the engine flywheel to the hydrostatic pump pulley.

The belt is a cord-reinforced rubber design.

Constant tension is applied to the drive belt by the use of a spring-loaded belt tensioner.

Adjusting

Figure 30-50-1

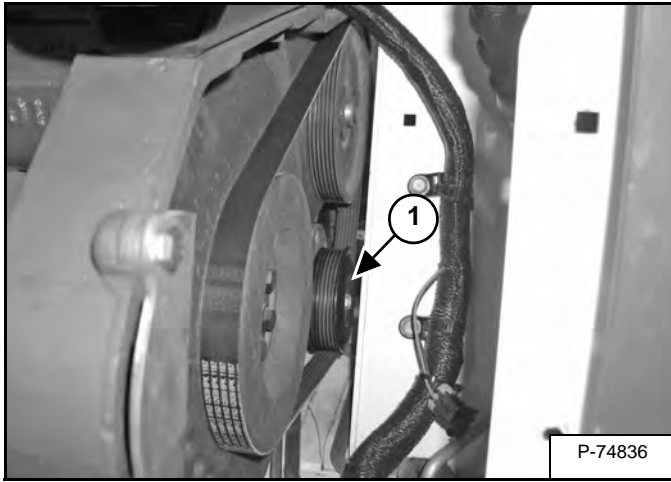

The adjustment of the drive belt is done automatically by means of a spring loaded tensioner pulley (Item 1) [Figure 30-50-1].

Belt Removal And Installation

Open the rear door of the loader.

Remove the negative (-) cable from the battery. (See Removal And Installation on Page 60-20-1.)

Figure 30-50-2

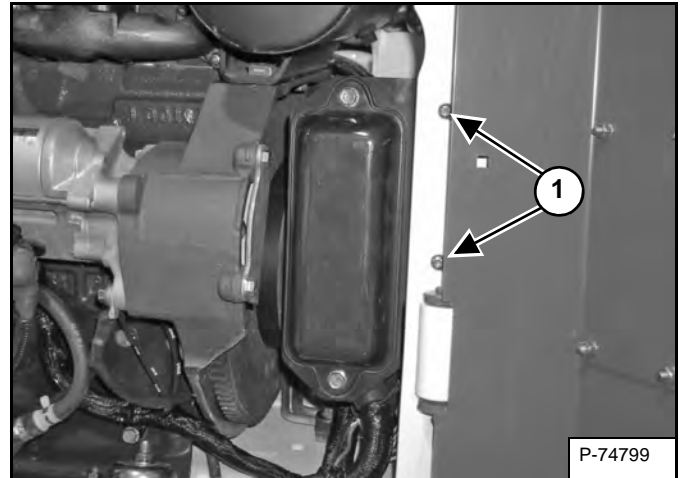

Remove the mounting bolts (Item 1) [Figure 30-50-2] from the fuse panel bracket.

Figure 30-50-3

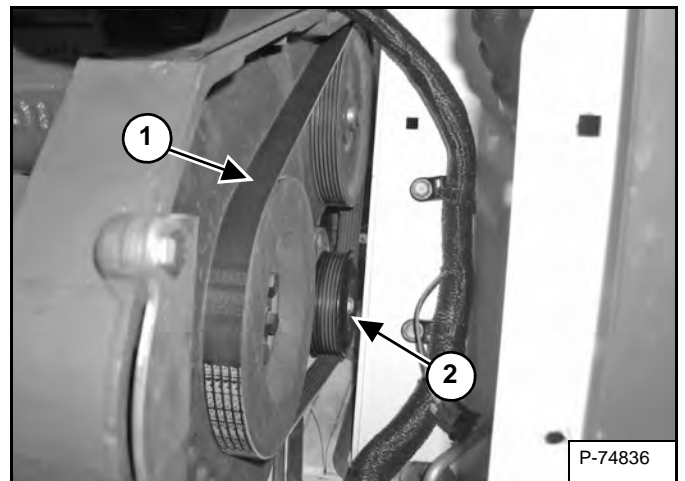

Loosen the drive belt (Item 1) by pulling the tension wheel (Item 2) [Figure 30-50-3] upwards with a socket wrench.

Remove the drive belt by pulling it back from the pulleys.

Install a new drive belt.

Reconnect the negative (-) cable to the battery.

DRIVE BELT (CONT'D)

Tensioner Pulley Removal And Installation

Remove the drive belt from the engine (See Belt Removal And Installation on Page 30-50-1.).

Figure 30-50-4

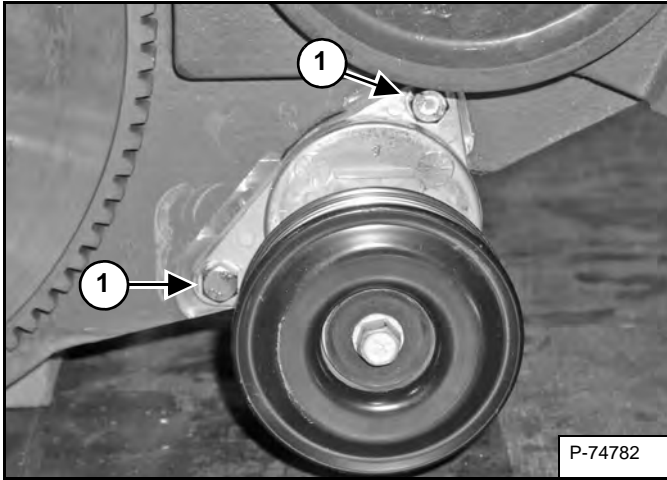

Remove the tensioner pulley from the engine by removing the two bolts (Item 1) **[Figure 30-50-4]**.

Tensioner Pulley Disassembly And Assembly

Figure 30-50-5

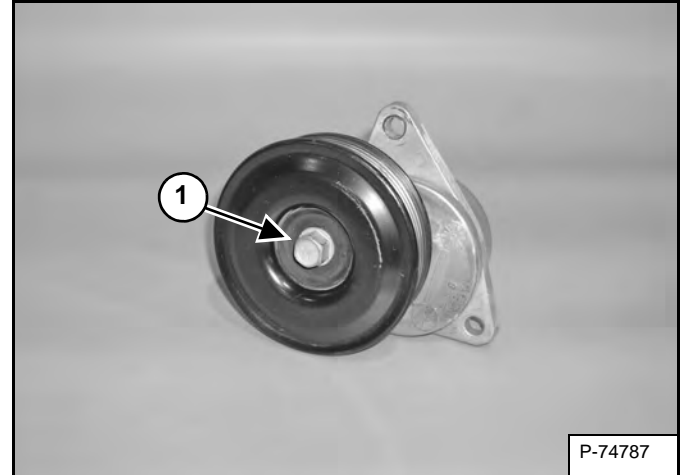

Remove the bolt (Item 1) **[Figure 30-50-5]** from the tensioner pulley and remove the black cover.

DRIVE SYSTEM

BRAKE	40-10-1
Description	40-10-1
Disc Removal And Installation	40-10-1
DRIVE COMPONENTS	40-20-1
Description	40-20-1
Axle Seal Removal And Installation	40-20-2
Axle, Sprocket And Bearings Removal And Installation	40-20-4
Chain Removal And Installation	40-20-8
CHAINCASE	40-30-1
Description	40-30-1
Chaincase Cover Removal And Installation	40-30-1
Chaincase Cover Disassembly And Assembly	40-30-2



Bobcat®

BRAKE

Description

Figure 40-10-1

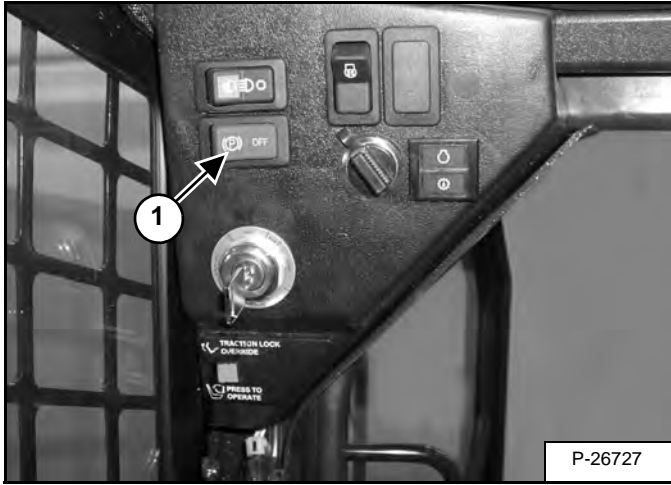

The brake is used to hold the machine in place. The brake is operated by a switch (Item 1) [Figure 40-10-1] located on the front accessory panel.

The brake is applied by a spring-loaded wedge that drops into two notched brake discs. An electric solenoid powered by a relay pulls the wedge away from the discs. A signal from the main controller holds the wedge away from the discs.

Disc Removal And Installation

Figure 40-10-2

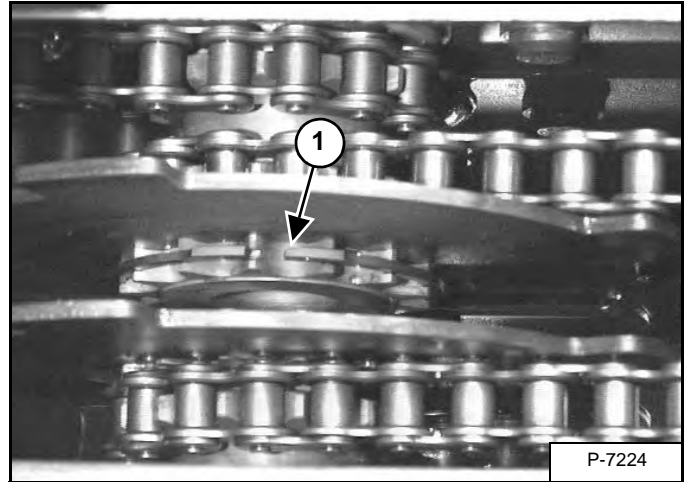

Remove the chaincase cover. (See Chaincase Cover Removal And Installation on Page 40-30-1.)

Use snap ring pliers to remove the snap ring (Item 1) [Figure 40-10-2] from the cluster sprocket.

Figure 40-10-3

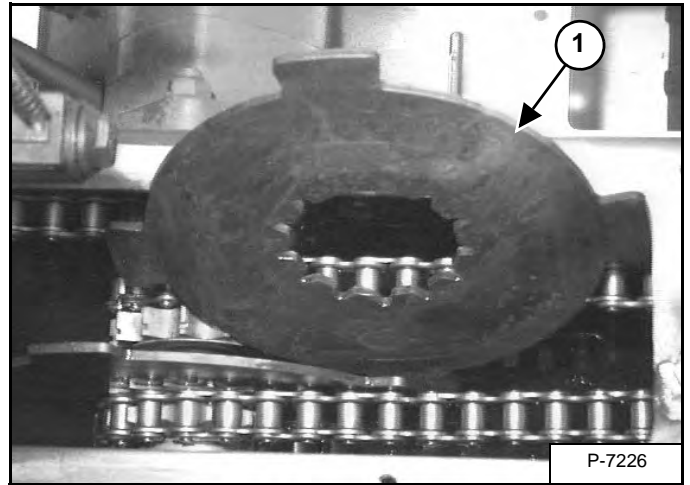

Remove the brake disc (Item 1) [Figure 40-10-3].

Reverse the procedure to install the parking brake disc.



Bobcat®

DRIVE COMPONENTS

Description

Figure 40-20-1

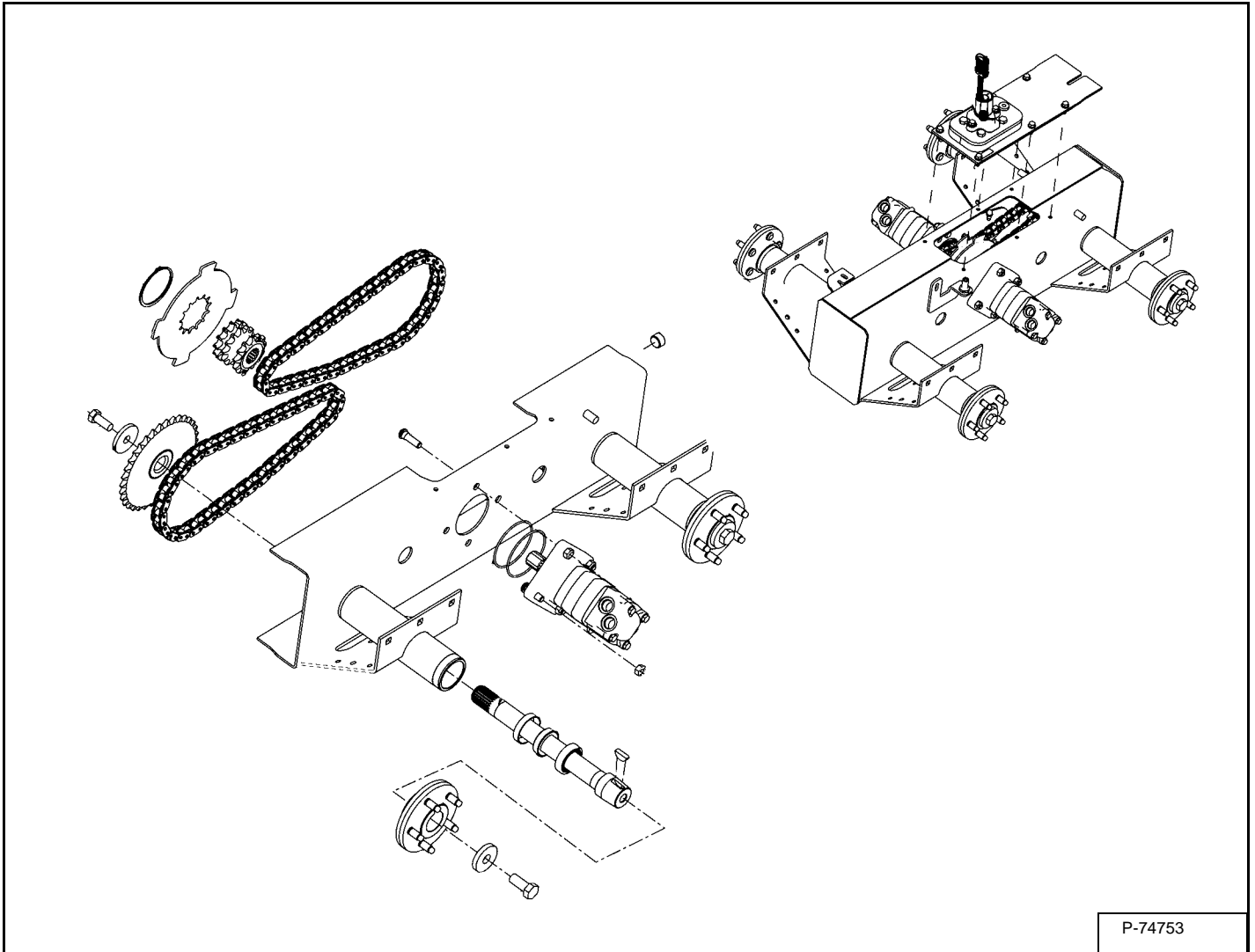

The drive components consist of a chaincase, drive chains, sprockets, axle shafts, hubs and a brake [Figure 40-20-1].

The chaincase is partially filled with hydraulic fluid to lubricate the chains and bearings.

DRIVE COMPONENTS (CONT'D)

Axle Seal Removal And Installation

WARNING

NEVER STAND IN-LINE OF THE HUB WHEN REMOVING A HUB FROM AN AXLE. The hub has a tapered fit on the axle end and can come off the axle with great force and cause serious injury.

W-2186-0395

Axle Hub Puller Tool
Slide Hammer
MEL1525 - Seal Driver Tool

NOTE: The procedure is the same for the front and rear axles. The front axle is shown for the procedure.

Loosen the axle hub mounting bolt, use the following procedure:

Before lifting and blocking the loader, loosen the hub mounting bolt.

NOTE: If the axle and bearings are being replaced, loosen the sprocket mounting bolt inside the chaincase before lifting and blocking the loader.

Installation: Install thread adhesive Loctite® #242 to the bolt threads and tighten the axle hub mounting bolt to 240 - 255 N•m (175 - 190 ft-lb) torque.

Lift and block the loader. (See Procedure on Page 10-10-1.)

Remove the front wheel from the loader.

Installation: Tighten the wheel mounting nuts to 68 - 75 N•m (50 - 55 ft-lb) torque.

Loosen the axle bolt 2 - 4 turns.

One of the wheel studs must be removed to position a puller for axle removal.

Figure 40-20-2

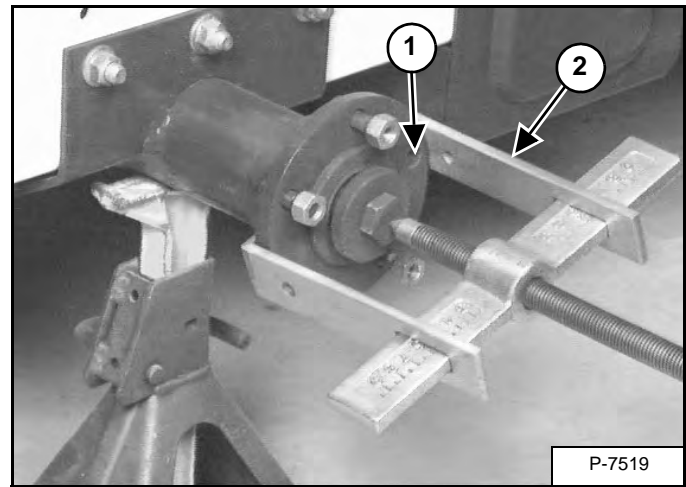

Install a nut on one wheel stud and strike the nut with a hammer to remove the stud (Item 1) [Figure 40-20-2].

Installation: Support the flange of the axle hub and install the stud with a hammer. Use a hydraulic press if available for this procedure.

Install the puller tool (Item 2) [Figure 40-20-2] on the axle hub bolt.

Turn the threaded rod of the puller to remove the axle hub from the axle.

DRIVE COMPONENTS (CONT'D)

Axle Seal Removal And Installation (Cont'd)

Figure 40-20-3

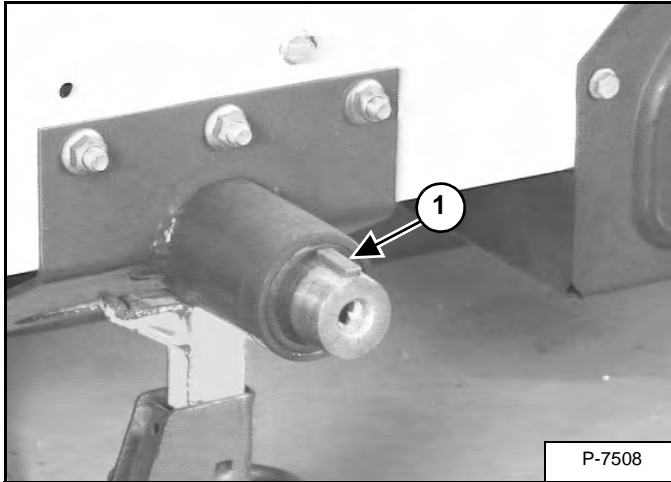

Remove the key (Item 1) [Figure 40-20-3] from the axle.

Figure 40-20-4

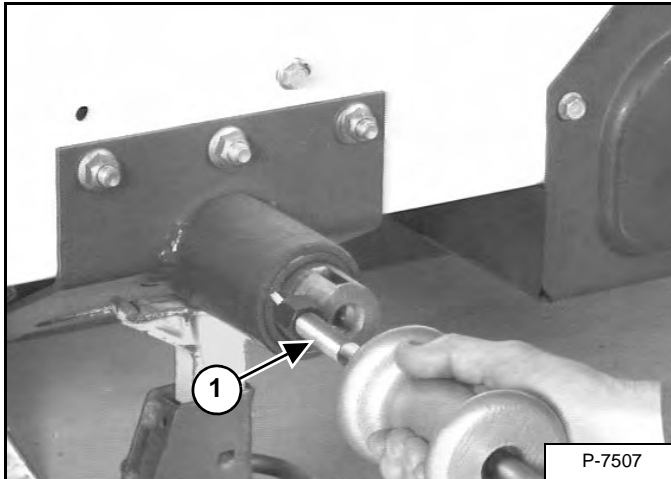

Drill a small hole in the axle seal [Figure 40-20-4].

Install a slide hammer (Item 1) [Figure 40-20-4] with a screw tip end in the drilled hole on the seal.

NOTE: More than one hole may need to be drilled in the seal for removal.

Remove the axle seal.

Installation: Use MEL1525 - seal driver to install the seal in the axle housing.

Clean the seal area and inspect the shaft for wear.

NOTE: If the shaft is damaged or worn, an axle repair sleeve kit is available from Bobcat Parts or remove the axle. (See Axle, Sprocket And Bearings Removal And Installation on Page 40-20-4.)

Lubricate the seal lips before installation.

Put the axle seal over the axle and into the axle tube.

Figure 40-20-5

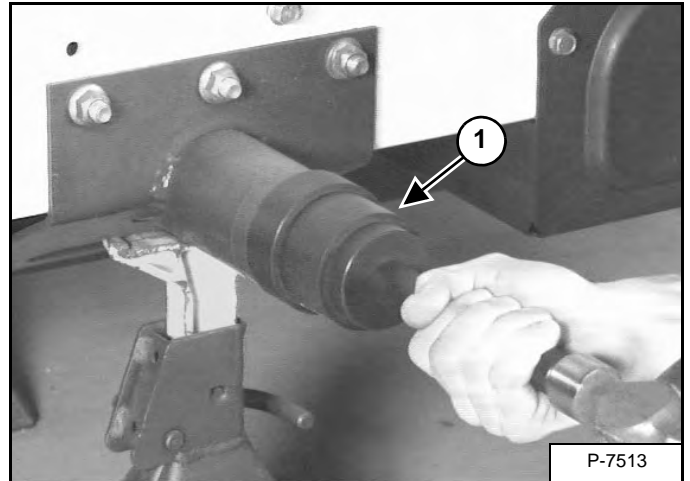

Install MEL1525 seal driver tool (Item 1) [Figure 40-20-5] over the end of the axle and against the seal.

Hit the seal driver tool with a hammer [Figure 40-20-5].

Figure 40-20-6

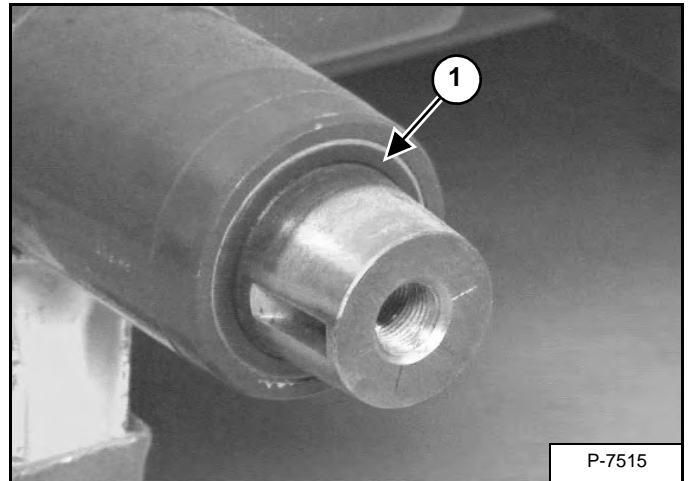

Drive the seal (Item 1) [Figure 40-20-6] into the axle tube until the seal tool is against the axle tube.

If installed correctly, the axle seal will be slightly recessed in the axle tube after installation.

Reverse the removal procedure to install the axle hub and wheel on the loader.

DRIVE COMPONENTS (CONT'D)

Axle, Sprocket And Bearings Removal And Installation

WARNING

Never work on a machine with the lift arms up unless the lift arms are secured by an approved lift arm support device. Failure to use an approved lift arm support device can allow the lift arms or attachment to fall and cause injury or death.

W-2059-0598

The tools listed are needed for the following procedure:

MEL1202 - Axle Bearing Service Tool
Slide Hammer

NOTE: The procedure shown is for removing the front axle, bearings and sprocket. This procedure can also be used for the rear axle, bearings and sprocket.

Raise the lift arms and install the lift arm support device. (See Installing on Page 10-20-1.)

Lift and block the loader. (See Procedure on Page 10-10-1.)

Raise the operator cab. (See Raising on Page 10-30-2.)

Remove the control shield and steering lever panels. (See Control Shield And Steering Lever Panels Removal And Installation on Page 50-90-1.)

Remove the chaincase cover. (See Chaincase Cover Removal And Installation on Page 40-30-1.)

Remove the oil from the chaincase. (See Removing And Replacing Oil on Page 10-130-1.)

Figure 40-20-7

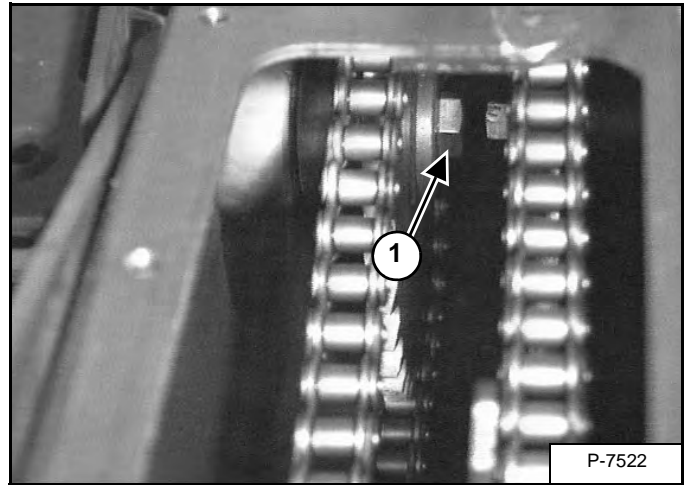

NOTE: A box end wrench should be used to loosen the bolt (Item 1) [Figure 40-20-7]. The wrench must be ground to fit between the two axle bolts.

Remove the axle hub. (See Axle Seal Removal And Installation on Page 40-20-2.)

Remove the hydrostatic motor. (See Removal And Installation on Page 30-20-1.)

Figure 40-20-8

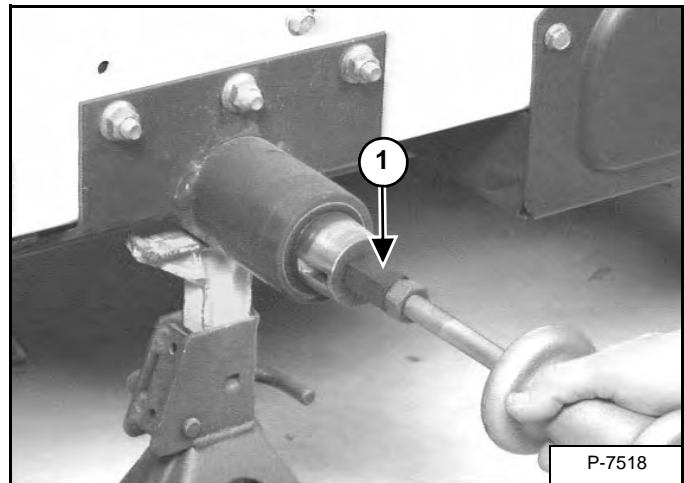

Install the axle puller (Item 1) [Figure 40-20-8], loosen the sprocket bolt as much as possible, and pull the axle out until the sprocket bolt stops the travel.

Repeat the procedure until the sprocket bolt is free from the axle. Remove the sprocket and bearing from the axle.

Installation: Apply grease to the axle bearing before installation.

Installation: Apply a small amount of liquid adhesive (Loctite® #242) to the bolt threads and tighten the bolt to 238 - 257 N•m (175 - 190 ft-lb) torque.

Remove the axle from the tube.

DRIVE COMPONENTS (CONT'D)

Axle, Sprocket And Bearings Removal And Installation (Cont'd)

Figure 40-20-9

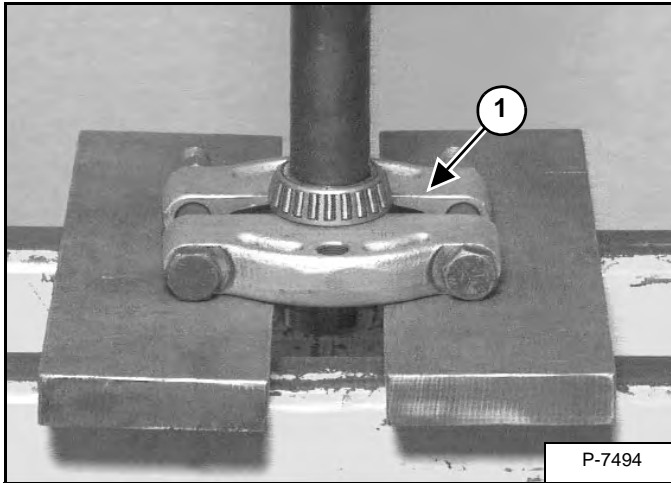

Install a bearing puller (Item 1) [Figure 40-20-9] between the bearing and the tapered flange for the hub. Be sure the bearing puller makes good contact with the inner race of the bearing.

Put the axle and the bearing puller in the hydraulic press [Figure 40-20-9].

Press the bearing off the mounting surface of the axle.

Be sure to hold onto the axle during removal. The bearing will slide freely along the axle shaft when the bearing is free of the mounting surfaces.

Figure 40-20-10

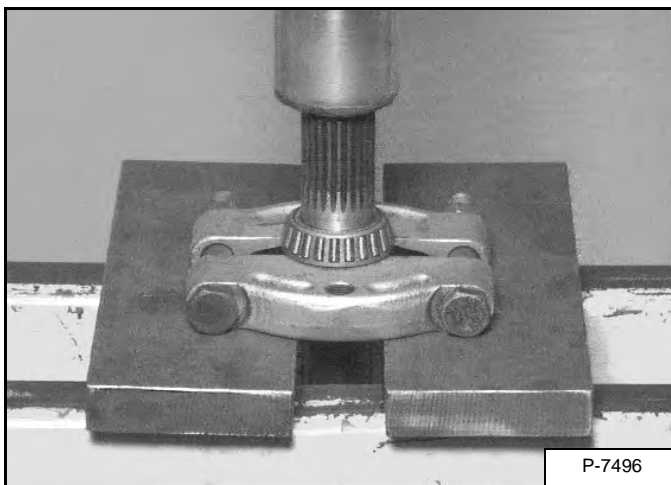

Press the bearing from the splined end of the axle [Figure 40-20-10].

Installation: Apply grease to the bearing before installation.

Figure 40-20-11

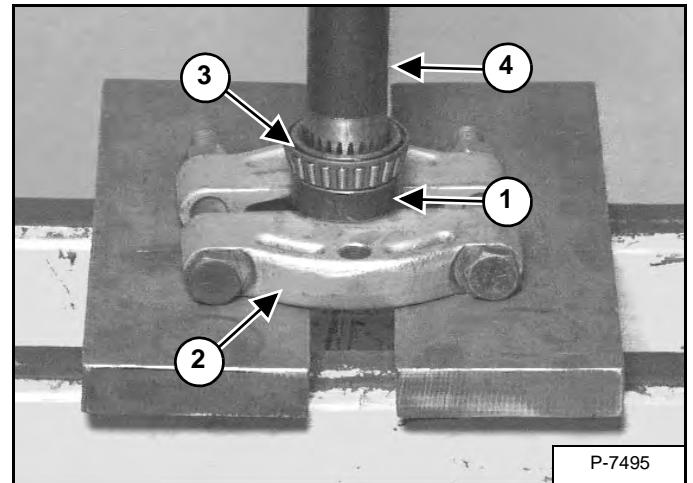

Installation: Use a piece of round tube (Item 1) [Figure 40-20-11] to install the bearing on the axle shaft. The inside diameter of the tube should be slightly larger than the inside diameter of the bearing race (for axle diameter clearance) and **must make contact with only the inner race during installation.**

Use the same bearing puller (Item 2) [Figure 40-20-11] to install the bearing on the axle.

Put the tube (Item 1) on the bearing puller (Item 2) [Figure 40-20-11].

Put the bearing (Item 3) [Figure 40-20-11] on the tube as shown.

Put the splined end of the axle shaft (Item 4) [Figure 40-20-11] in the bearing and press the bearing onto the axle.

Be sure to hold the axle during installation. It will slide freely along the axle shaft after the splined end has passed through the bearing until it reaches the bearing mounting surface on the hub end of the axle.

DRIVE COMPONENTS (CONT'D)

Axle, Sprocket And Bearings Removal And Installation (Cont'd)

Figure 40-20-12

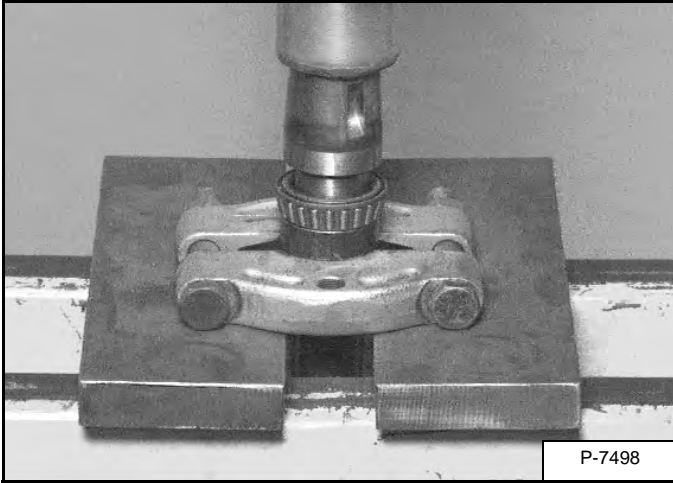

Press the bearing until it is fully seated on the mounting surface at the hub end of the axle [Figure 40-20-12].

Figure 40-20-13



Use the tools provided in the MEL1202A Axle Bearing Service Set for bearing cup removal and installation. A slide hammer is also necessary for this procedure.

Use the long rod and bearing cup tool to remove the inner bearing cup [Figure 40-20-13].

Hit the long rod with a hammer to remove the inner bearing cup from the axle tube [Figure 40-20-13].

Figure 40-20-14

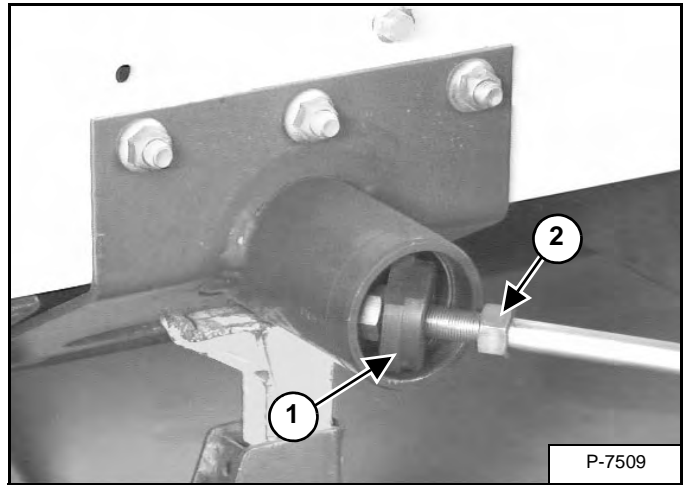

To remove the outer bearing cup, put the bearing cup tool (Item 1) [Figure 40-20-14] on the slide hammer.

Leave the bearing cup tool loose until the tool is installed inside the tube [Figure 40-20-14].

After the bearing cup tool is inside the axle tube, pull the tool against the bearing cup and tighten the nut (Item 2) [Figure 40-20-14] on the tool.

Figure 40-20-15

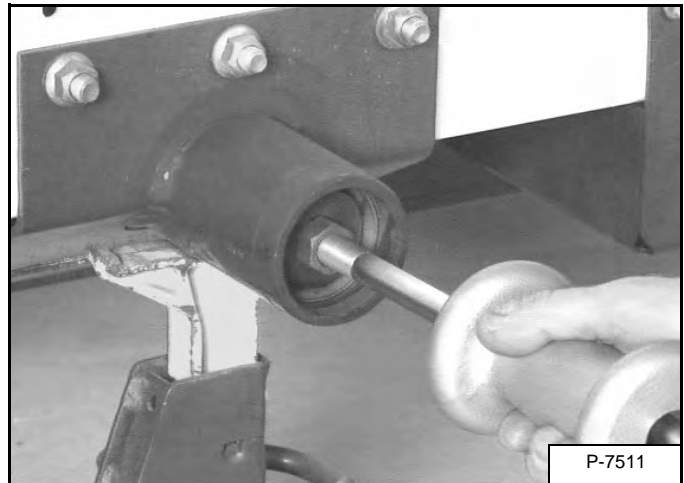

Use the slide hammer to remove the bearing cup from the axle tube [Figure 40-20-15].

DRIVE COMPONENTS (CONT'D)

Axle, Sprocket And Bearings Removal And Installation (Cont'd)

Figure 40-20-16

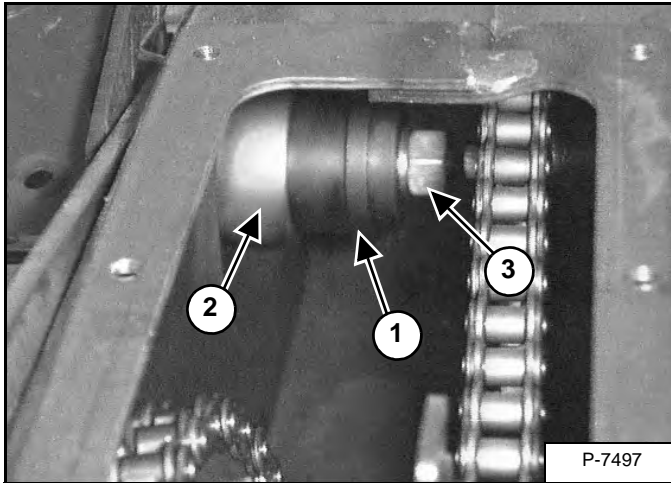
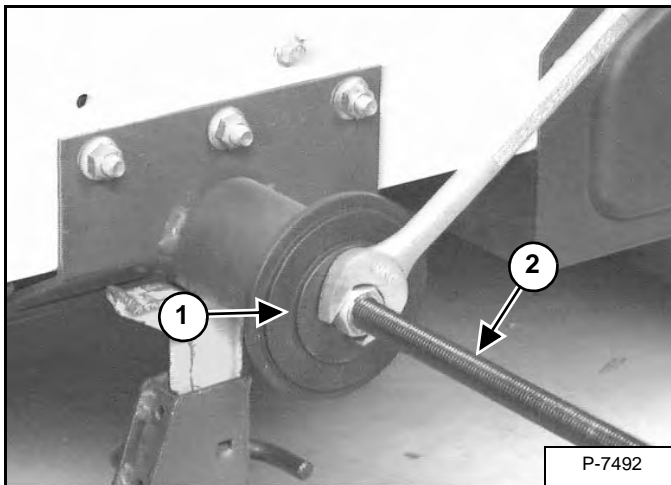

Figure 40-20-17



Use the bearing cup installation tool (Item 1) [Figure 40-20-16] and [Figure 40-20-17] and the long threaded rod (Item 2) [Figure 40-20-17] from the service set to install the inner and outer bearing cups.

Put the inner bearing cup in the axle tube (Item 2) [Figure 40-20-16].

Put the installation tool (Item 1) [Figure 40-20-16] in the axle tube.

Install the long threaded rod (Item 2) [Figure 40-20-17] into the axle tube with the threaded rod through the installation tool (Item 1) [Figure 40-20-16].

Secure the tool to the threaded rod with a nut (Item 3) [Figure 40-20-16].

Put the installation tool (Item 1) [Figure 40-20-17] in the axle tube with the threaded rod through the hole in the tool.

Secure the tool to the threaded rod with a nut [Figure 40-20-17].

Hold the inside nut (Item 3) [Figure 40-20-16] with a wrench and tighten the outside nut as shown in photo [Figure 40-20-17].

Tighten the nut until the bearing cup is seated.

Figure 40-20-18

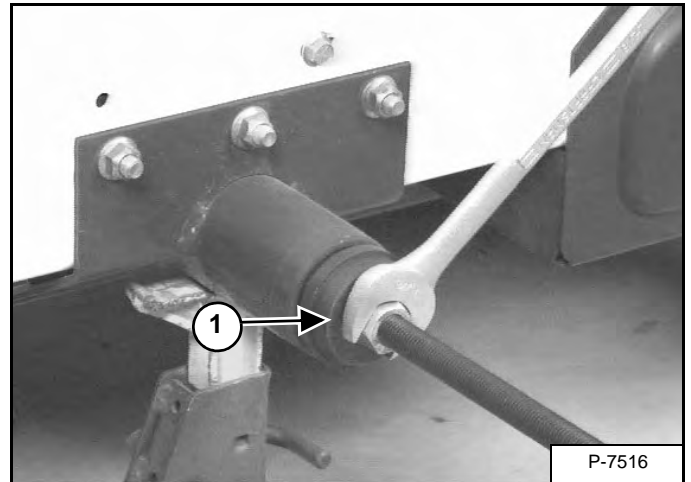

Install the outer bearing cup, install the installation tool (Item 1) [Figure 40-20-18] and tighten the nut until the bearing is seated.

DRIVE COMPONENTS (CONT'D)

Chain Removal And Installation

WARNING

Never work on a machine with the lift arms up unless the lift arms are secured by an approved lift arm support device. Failure to use an approved lift arm support device can allow the lift arms or attachment to fall and cause injury or death.

W-2059-0598

Lift and block the loader. (See Procedure on Page 10-10-1.)

Raise the lift arms and install the lift arm support device. (See Installing on Page 10-20-1.)

Raise the operator cab. (See Raising on Page 10-30-2.)

Remove the control shield and steering lever panels. (See Control Shield And Steering Lever Panels Removal And Installation on Page 50-90-1.)

Remove the chaincase cover. (See Chaincase Cover Removal And Installation on Page 40-30-1.)

Remove the brake disc. (See Disc Removal And Installation on Page 40-10-1.)

Remove the axle hub. (See Axle Seal Removal And Installation on Page 40-20-2.)

Remove the hydrostatic motor. (See Removal And Installation on Page 30-20-1.)

Remove the axle. (See Axle, Sprocket And Bearings Removal And Installation on Page 40-20-4.)

Figure 40-20-19

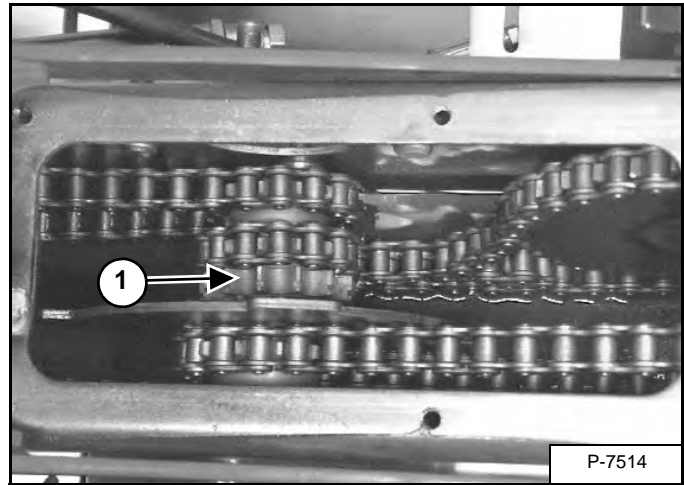

Remove the cluster sprocket (Item 1) [Figure 40-20-19] from the drive chains.

Figure 40-20-20

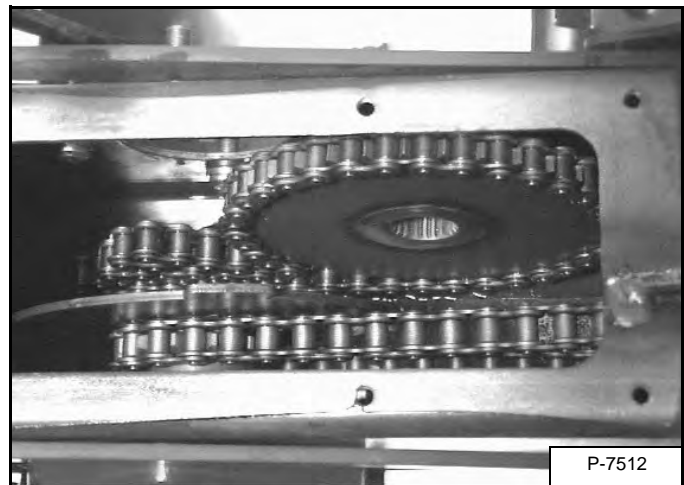

Remove the drive chain and axle sprocket from the chaincase [Figure 40-20-20].

NOTE: Installing an old or new chain will be easier if the above removal procedure is followed.

NOTE: Due to the small area in the chaincase, assemble a new chain on a bench before installation, using a chain compression tool.

CHAINCASE

Description

The chaincase contains the drive components.

Chaincase Cover Removal And Installation



P-90328

AVOID DEATH

- Disconnecting or loosening any hydraulic tubeline, hose, fitting, component or a part failure can cause lift arms to drop.
- Keep out of this area when lift arms are raised unless supported by an approved lift arm support. Replace if damaged.

D-1009-0409



Never work on a machine with the lift arms up unless the lift arms are secured by an approved lift arm support device. Failure to use an approved lift arm support device can allow the lift arms or attachment to fall and cause injury or death.

W-2059-0598

Raise the loader arms and install the lift arm support device. (See Installing on Page 10-20-1.)

Put jackstands under the rear of the loader. (See Procedure on Page 10-10-1.)

Raise the operator cab. (See Raising on Page 10-30-2.)

Remove the control shield and steering lever panels. (See Control Shield And Steering Lever Panels Removal And Installation on Page 50-90-1.)

Figure 40-30-1

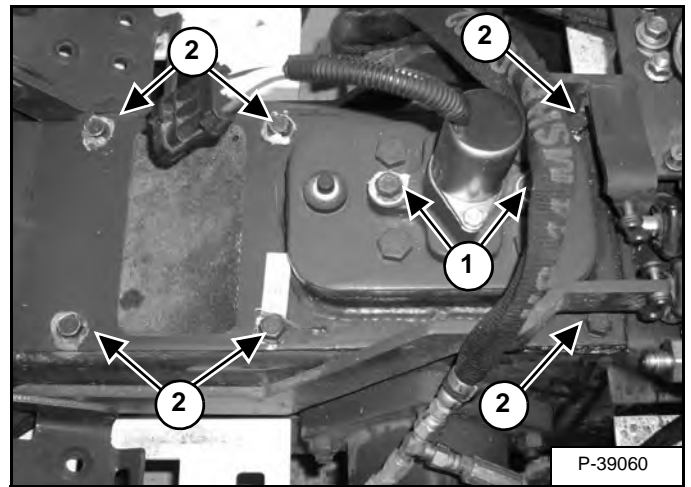

Disconnect the electrical harness for the parking brake.

Remove the steering levers assembly. (See Lever Removal And Installation on Page 50-100-1.)

Remove the mounting bracket bolts (Item 1) [Figure 40-30-1] from the brake solenoid.

Remove the mounting bolts (Item 2) [Figure 40-30-1] from the chaincase cover.

CHAINCASE (CONT'D)

Chaincase Cover Disassembly And Assembly

Figure 40-30-2

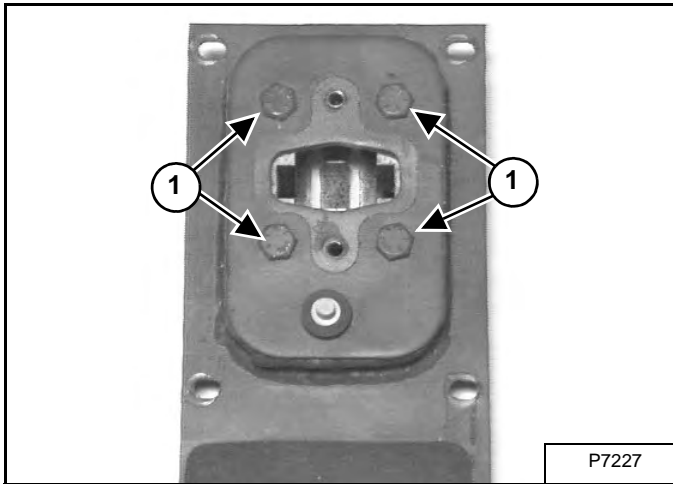

Remove the four bolts (Item 1) [Figure 40-30-2] from the brake disc guide block.

Assembly: Put liquid adhesive (Loctite® 242) on the bolt threads for the disc guide block. Tighten the bolts to 88 - 95 N•m (65 - 70 ft-lb) torque.

Figure 40-30-3

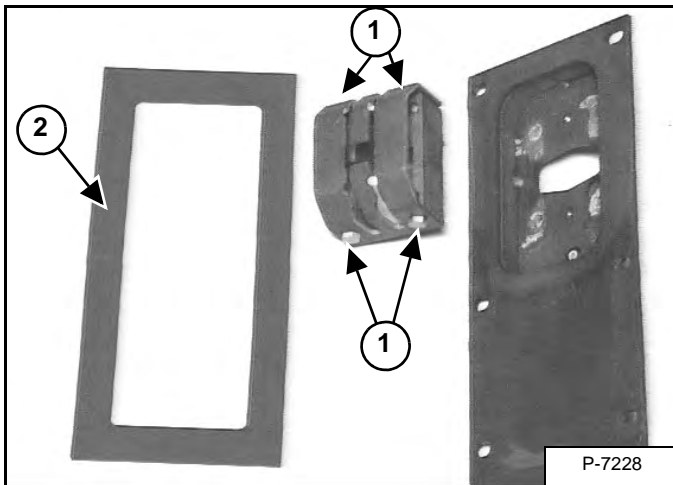

Remove the four mounting bolts (Item 1) [Figure 40-30-3] from the disc guides.

Figure 40-30-4

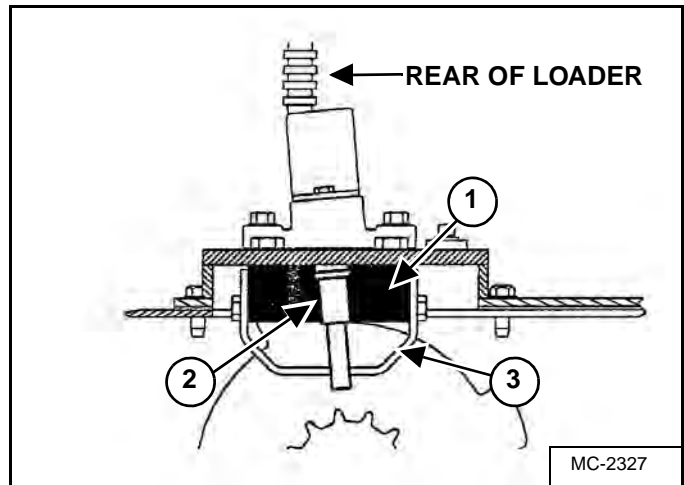

Assembly: The guide blocks (Item 1) have angled slots (Item 2) which must be parallel to each other when installed in the disc guide (Item 3) [Figure 40-30-4]. When installed in the chaincase cover correctly the top of both slots must be toward the rear of the loader. Put liquid adhesive (Loctite® #242) on the bolt threads for the disc guide. Tighten the bolts to 34 - 38 N•m (25 - 28 ft-lb) torque.

Installation: Install a new gasket (Item 2) [Figure 40-30-3] under the cover during assembly.

MAINFRAME

SEAT BAR	50-10-1
Description	50-10-1
Removal And Installation	50-10-1
Disassembly And Assembly	50-10-4
Compression Spring Disassembly And Assembly	50-10-5
OPERATOR CAB	50-20-1
Gas Cylinder Removal And Installation	50-20-1
Removal And Installation	50-20-3
OPERATOR SEAT	50-30-1
Removal And Installation	50-30-1
Seat Belt Removal And Installation	50-30-1
BOB-TACH	50-40-1
Description	50-40-1
Removal And Installation	50-40-1
Lever And Wedge Disassembly And Assembly	50-40-3
LIFT ARMS	50-50-1
Removal And Installation	50-50-1
REAR DOOR	50-60-1
Removal And Installation	50-60-1
FUEL TANK	50-70-1
Removal And Installation	50-70-1
CONTROL PEDALS AND LINKAGES	50-80-1
Description	50-80-1
Pedal Removal And Installation	50-80-1
Pedal Interlock Linkage Removal And Installation	50-80-2
CONTROL PANEL	50-90-1
Description	50-90-1
Control Shield And Steering Lever Panels Removal And Installation	50-90-1
CONTROL LEVER	50-100-1
Description	50-100-1
Lever Removal And Installation	50-100-1
Lever Disassembly And Assembly	50-100-3
Linkage Neutral Adjustment	50-100-4
Pintle Arm Removal	50-100-5
Pintle Arm Installation	50-100-8
Pintle Arm Disassembly And Assembly	50-100-10

WINDOW (REAR)	50-110-1
Removal	50-110-1
Installation	50-110-1
WINDOW (TOP)	50-111-1
Removal	50-111-1
Installation	50-111-2

SEAT BAR

Description

The seat bar is the secondary restraint system which has a sensor that automatically stops the loader functions until the seat bar is lowered.

The seat bar is located in the operator cab.

Removal And Installation

Figure 50-10-1

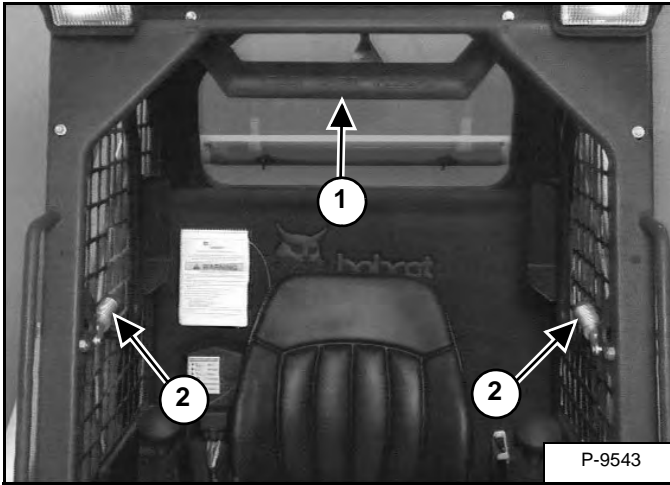

Lower the seat bar (Item 1) so the compression springs (Item 2) [Figure 50-10-1] will be in a down position.

Figure 50-10-2

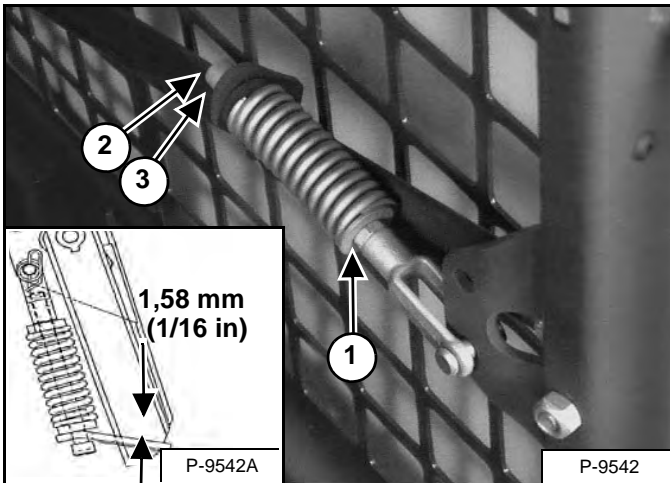

Loosen the adjustment locknut (Item 1) [Figure 50-10-2] (both sides).

Figure 50-10-3

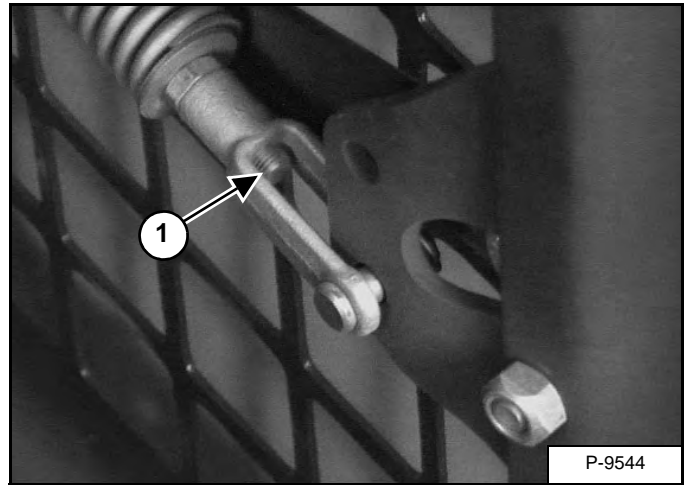

Turn the bolt (Item 1) [Figure 50-10-3] into the clevis five turns (both sides).

Installation: Adjust the clearance between the bolt head (Item 2) and the seat bar tab (Item 3) [Figure 50-10-2] to 1,58 mm (1/16 in).

Figure 50-10-4

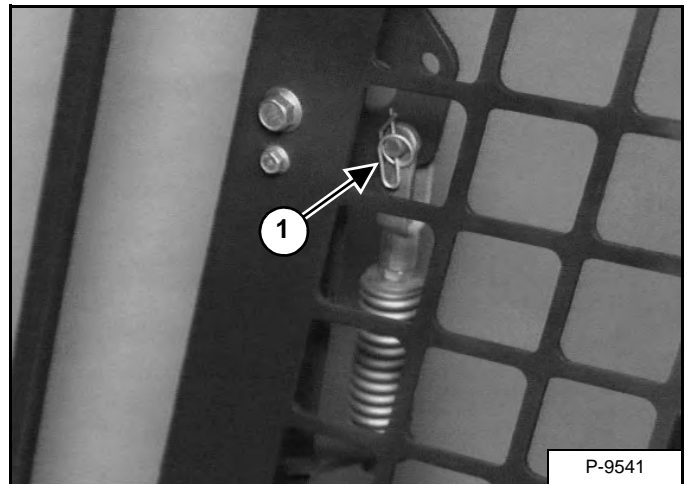

Remove the retaining pin (Item 1) [Figure 50-10-4] and clevis pin (both sides).

SEAT BAR (CONT'D)

Removal And Installation (Cont'd)

Figure 50-10-5

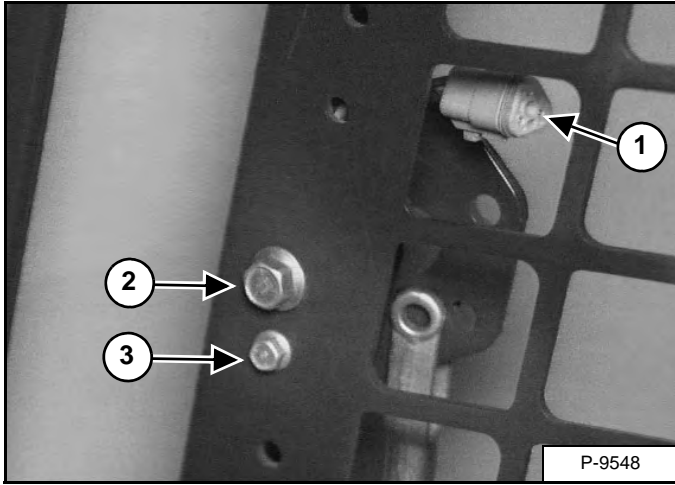

Disconnect the wiring harness connector (Item 1) [Figure 50-10-5] (left side).

Remove the seat bar mounting bolt (Item 2) [Figure 50-10-5] (both sides).

Remove the sensor mounting bolt (Item 3) [Figure 50-10-5] (left side).

Figure 50-10-6

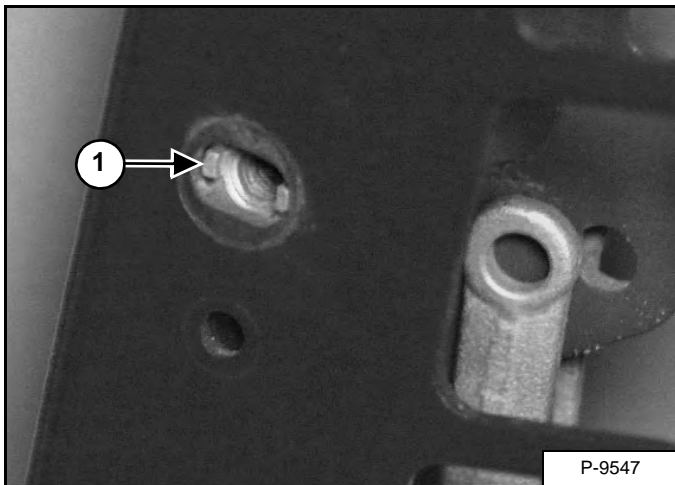

Installation: Make sure the two tabs (Item 1) [Figure 50-10-6] are located in the slot in the operator cab.

Figure 50-10-7

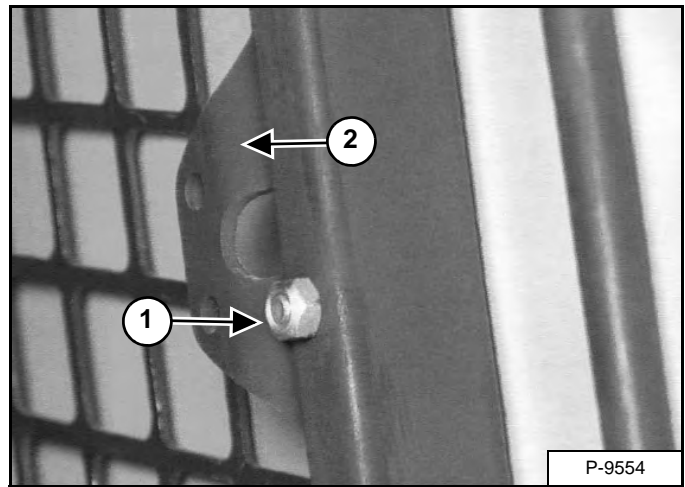

Remove the mounting bolt and nut (Item 1) and remove the mounting bracket (Item 2) [Figure 50-10-7] (both sides).

Installation: Tighten the mounting bolt and nut (Item 1) [Figure 50-10-7] to 21 - 23 N•m (180 - 200 in-lb) torque.

Figure 50-10-8

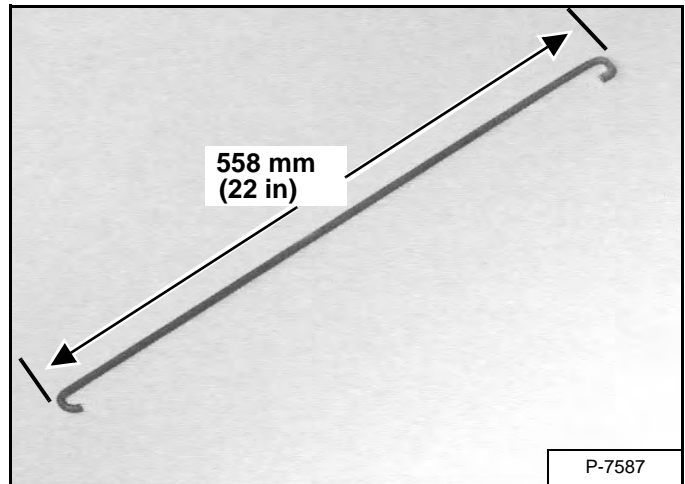

NOTE: Hook a 3/16 inch diameter rod, 558 mm (22 in) long, in each end as shown [Figure 50-10-8]. Pulling the seat bar together and holding it at the pivot holes with the 3/16 inch rod, will make removal and installation easier.

SEAT BAR (CONT'D)

Removal And Installation (Cont'd)

Figure 50-10-9

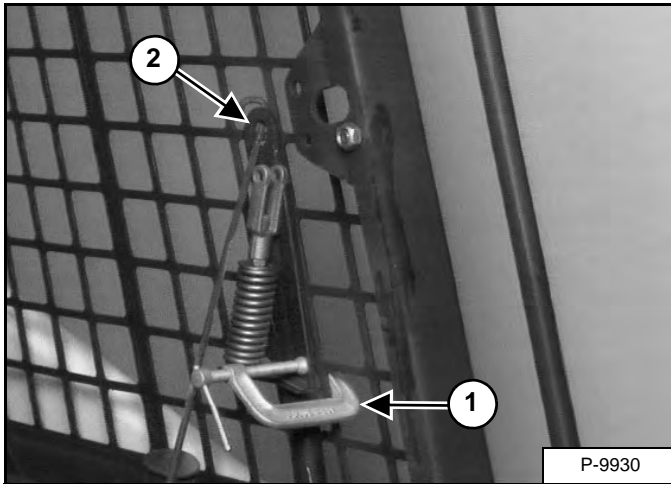

Use a clamp (Item 1) [Figure 50-10-9] to hold one side of the seat bar against the side screen.

Install the rod (Item 2) [Figure 50-10-9] in the pivot hole.

Figure 50-10-10

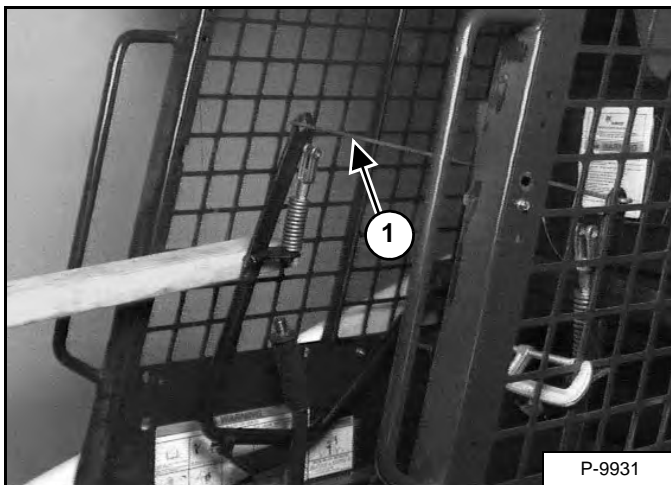

Use a wooden 2 x 4, installed with one end against the other side screen to pry the seat bar together [Figure 50-10-10].

Install the rod (Item 1) [Figure 50-10-10] in the seat bar pivot hole.

Remove the wooden 2 x 4.

Remove the C-clamp.

Figure 50-10-11

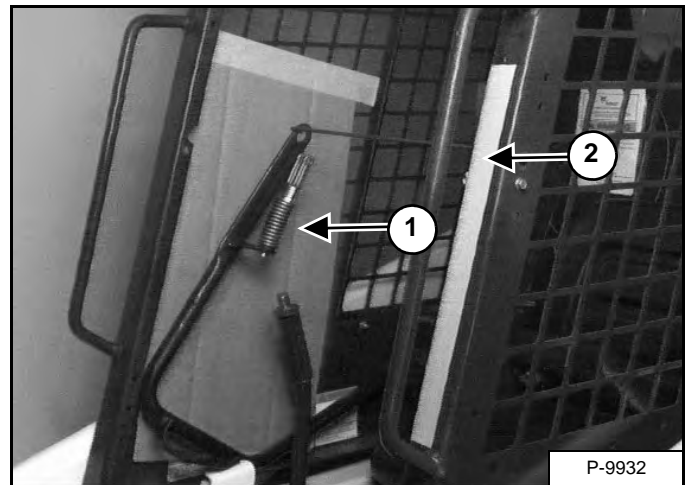

To prevent damage, use cardboard (Item 1) and duct tape (Item 2) [Figure 50-10-11] to protect the cab during removal and installation.

Figure 50-10-12

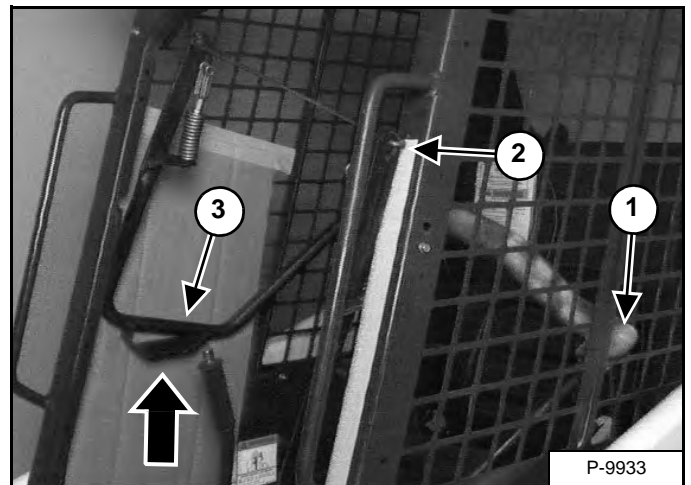

Position the seat bar in the recess of the left side of the cab (Item 1). Position the left side pivot end of the seat bar between the cab and the grab handle (Item 2) [Figure 50-10-12].

Lift straight up on the right side of the seat bar (Item 3) [Figure 50-10-12].

Continue to lift on the right side of the seat bar and allow the left side to rotate between the cab and the grab handle. Lift the right side of the seat bar until it clears the right side screen of the cab.

Reverse the above procedure to install the seat bar into the operator cab.

SEAT BAR (CONT'D)

Disassembly And Assembly

Figure 50-10-13

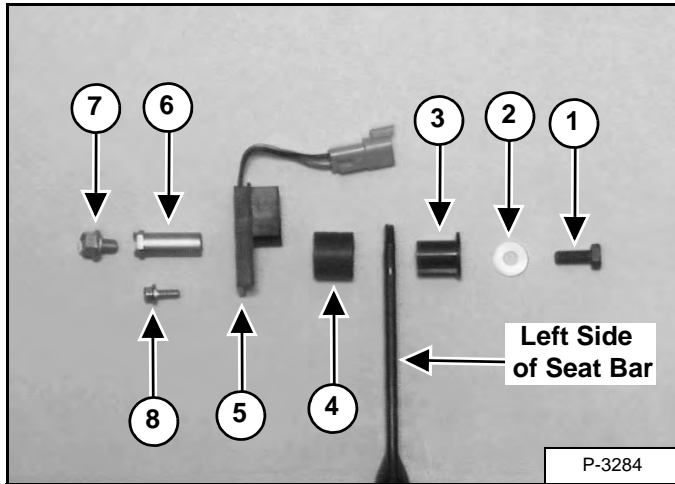

Assemble the parts as shown for the left side of the seat bar pivot assembly [Figure 50-10-13].

- Mounting Bolt - (Item 1).
- Washer - (Item 2).
- Keyed Plastic Bushing - (Item 3).
- Magnetic Bushing Assembly - (Item 4).
- Sensor Bracket - (Item 5).
- Pivot Bushing - (Item 6).
- Mounting Bolt - (Item 7).
- Sensor Mounting Bolt - (Item 8).

Figure 50-10-14

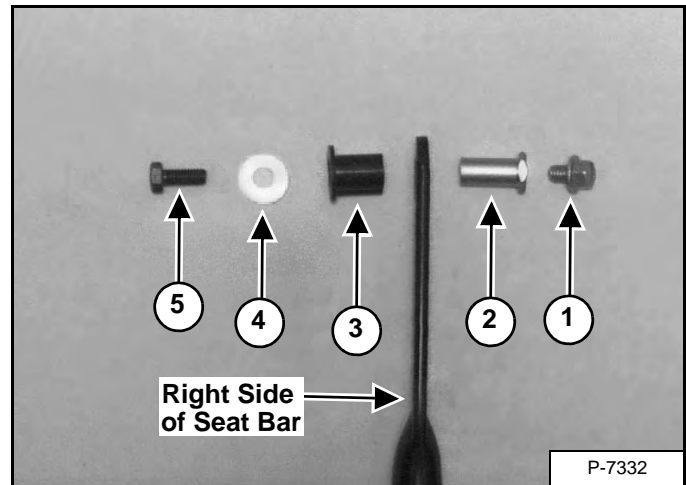

Assemble the parts as shown for the right side of the seat bar pivot assembly [Figure 50-10-14].

- Mounting Bolt - (Item 1).
- Pivot Bushing - (Item 2).
- Keyed Plastic Bushing - (Item 3).
- Washer - (Item 4).
- Mounting Bolt - (Item 5).

Tighten the mounting bolt to 21 - 23 N•m (180 - 200 in-lb) torque.

SEAT BAR (CONT'D)

Compression Spring Disassembly And Assembly

Figure 50-10-15

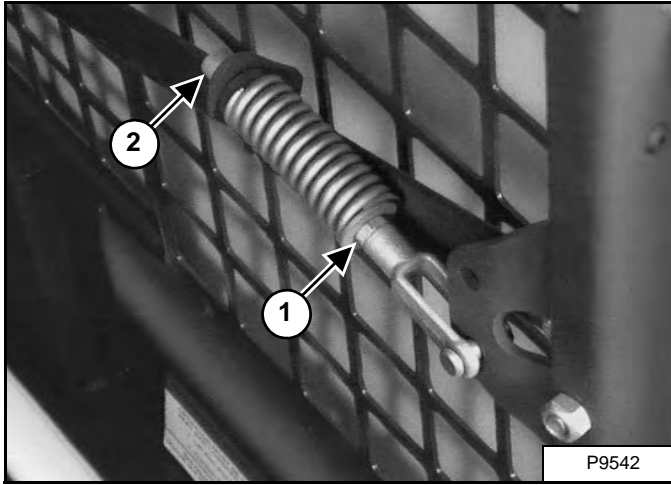

Loosen the locknut (Item 1) and turn the bolt (Item 2) out of the clevis. **[Figure 50-10-15]**

Assembly: Adjust the compression spring as shown on Page 50-10-1.

Figure 50-10-16

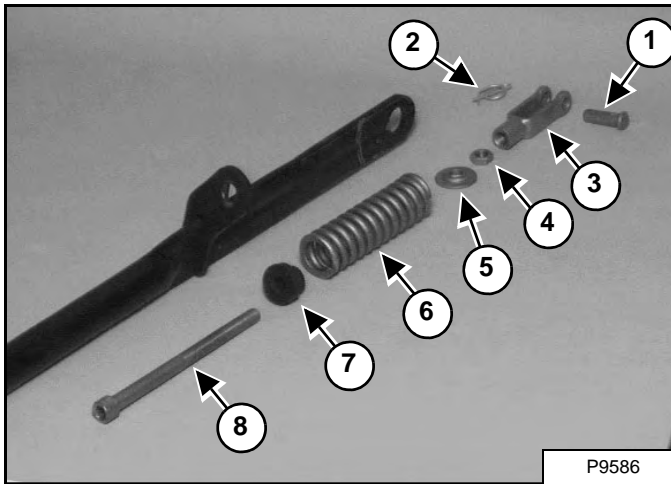

Assemble the parts as shown for the compression spring assembly **[Figure 50-10-16]**.

- Pin - (Item 1).
- Retaining Pin - (Item 2).
- Clevis - (Item 3).
- Locknut - (Item 4).
- Washer - (Item 5).
- Spring - (Item 6).
- Bushing - (Item 7).
- Bolt - (Item 8).



Bobcat®

OPERATOR CAB

Gas Cylinder Removal And Installation

WARNING

AVOID INJURY OR DEATH

The cab must be held to prevent falling while hand is in access hole.

W-2205-1207

WARNING

Never work on a machine with the lift arms up unless the lift arms are secured by an approved lift arm support device. Failure to use an approved lift arm support device can allow the lift arms or attachment to fall and cause injury or death.

W-2059-0598

Put jackstands under the rear corners of the loader. (See Procedure on Page 10-10-1.)

Raise the lift arm and install the arm support device. (See Installing on Page 10-20-1.)

Raise the operator cab. (See Raising on Page 10-30-2.)

Figure 50-20-1

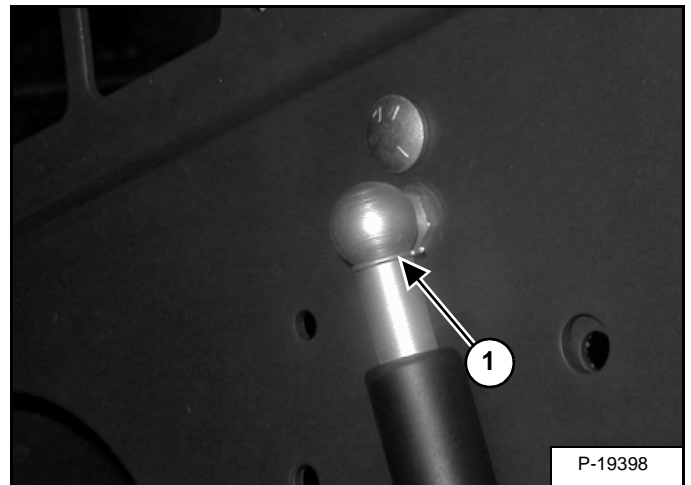

Turn the clip (Item 1) [Figure 50-20-1] to remove it from the hole in the base end of the cylinder.

Figure 50-20-2

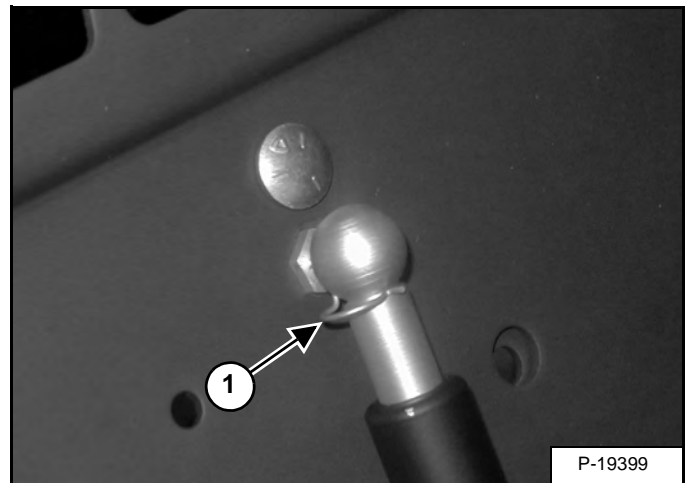

Pull the clip (Item 1) [Figure 50-20-2] enough to clear the base end ball of the cylinder.

OPERATOR CAB (CONT'D)

Gas Cylinder Removal And Installation (Cont'd)

Figure 50-20-3

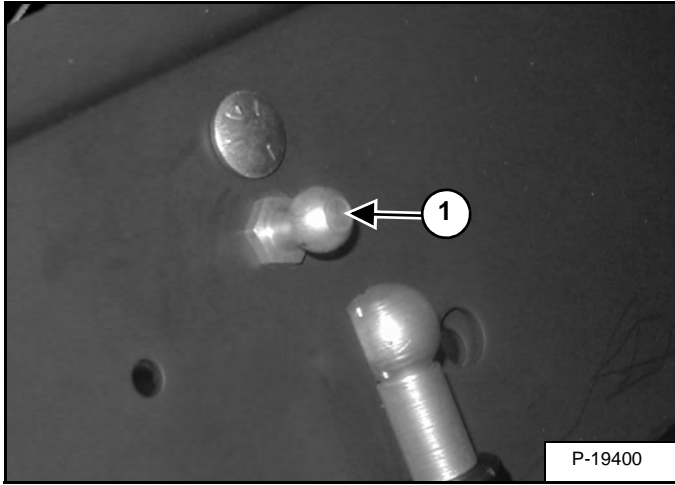

Rotate the cylinder to remove it from the ball (Item 1) [Figure 50-20-3]

Figure 50-20-4

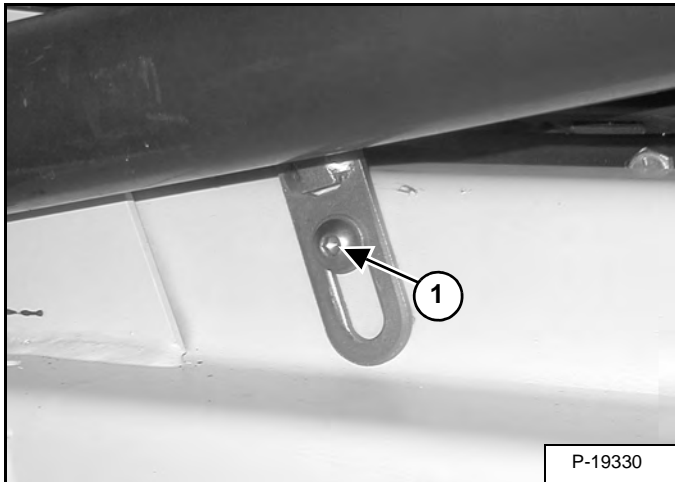

Hold the nut under the fender and remove the bolt (Item 1) [Figure 50-20-4] from the rod end of the cylinder.

Remove the cylinder.

Reverse the procedure to install the gas cylinder.

OPERATOR CAB (CONT'D)

Removal And Installation

Figure 50-20-5



Put jackstands under the rear corners of the loader. (See Procedure on Page 10-10-1.)

Raise the operator cab. (See Raising on Page 10-30-2.)

Install a lift strap through the grab handles and connect the lift strap to a chain hoist to support the operator cab [Figure 50-20-5].

Release the lock pin.

Figure 50-20-6

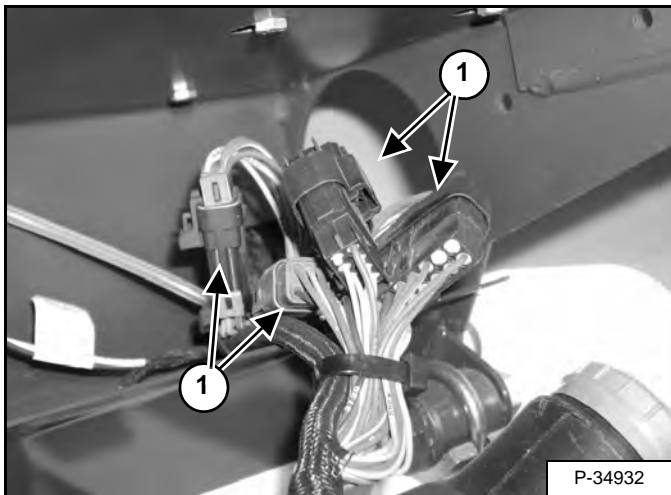

Disconnect the electrical harnesses (Item 1) [Figure 50-20-6] From the operator cab.

Remove the gas cylinder from the operator cab. (See Gas Cylinder Removal And Installation on Page 50-20-1.)

Figure 50-20-7

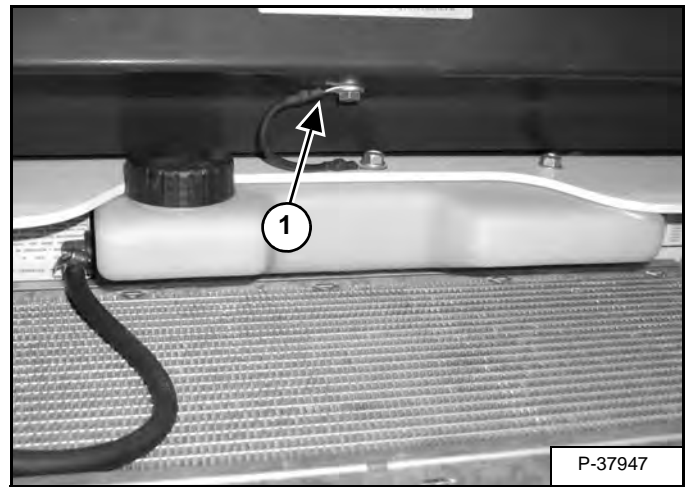

Disconnect the ground wire (Item 1) [Figure 50-20-7] from the operator cab.

Figure 50-20-8

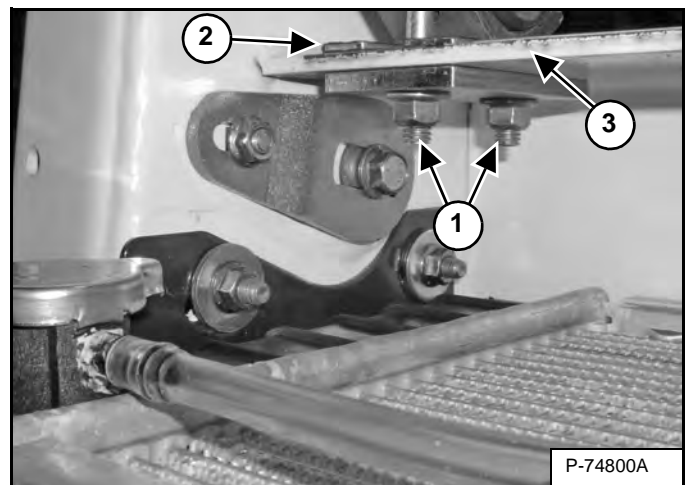

Remove the nuts (Item 1) [Figure 50-20-8] from the U-bolts (both sides).

Installation: Assemble the spacer plate (Item 2) above the mainframe plate (Item 3).

OPERATOR CAB (CONT'D)

Removal And Installation (Cont'd)

Figure 50-20-9

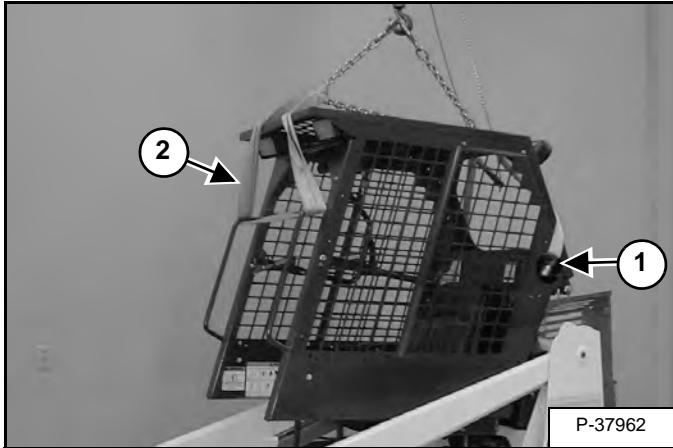

Install a lift strap through the fuel fill access hole (Item 1) [Figure 50-20-9] in the operator cab.

Use a chain connected to the two lift straps (Item 1 and 2) [Figure 50-20-9] and remove the operator cab.

Reverse the procedure to install the operator cab.

OPERATOR SEAT

Removal And Installation

Put jackstands under the rear of the loader. (See Procedure on Page 10-10-1.)

Raise the operator cab. (See Raising on Page 10-30-2.)

Figure 50-30-1

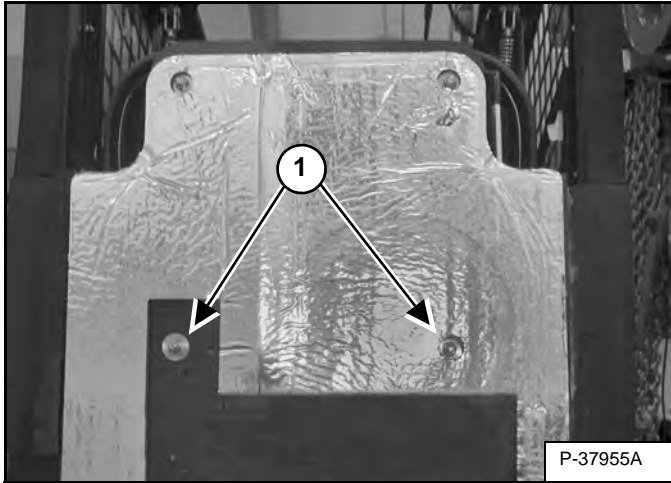

Remove the four seat mounting nuts (Item 1) [Figure 50-30-1] and washers from the operator seat mounting studs.

Installation: Tighten the mounting nuts to 27 N•m (20 ft-lb) torque.

Lower the cab and remove the operator seat from the cab.

Seat Belt Removal And Installation

Raise the operator cab. (See Raising on Page 10-30-2.)

Figure 50-30-2

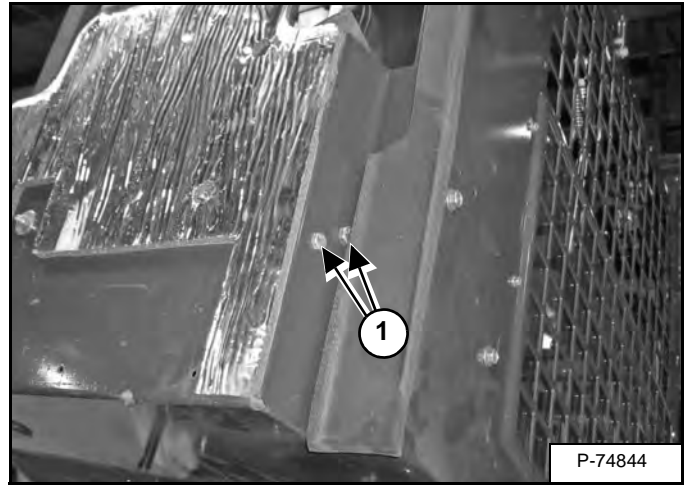

Locate the seat belt bolts (Item 1) [Figure 50-30-2] on the side of the seat pan.

Figure 50-30-3

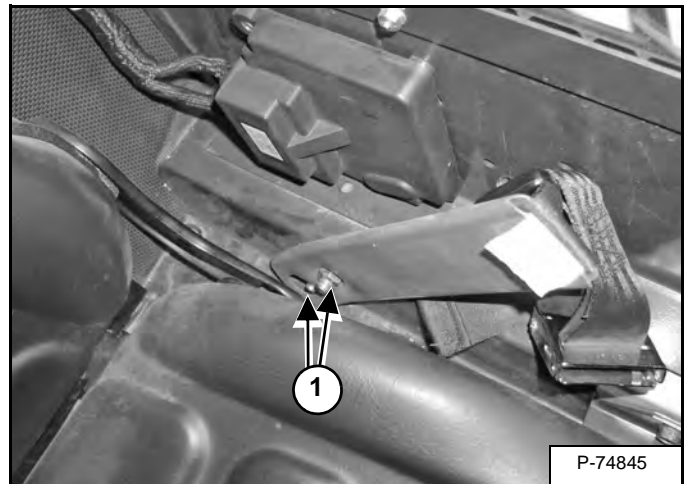

Lower the two nuts (Item 1) [Figure 50-30-3] from the seat mount.

Repeat for other half of seat belt and guide.



Bobcat®

BOB-TACH

Description

The Bob-Tach is the section of the loader lift arm that attachments mount to. The Bob-Tach uses two manually operated, spring assisted, locking wedge and lever assembled to secure the attachment to the Bob-Tach.

The Bob-Tach is located on the front of the loader and is connected to the lift arms.

Removal And Installation

Figure 50-40-1

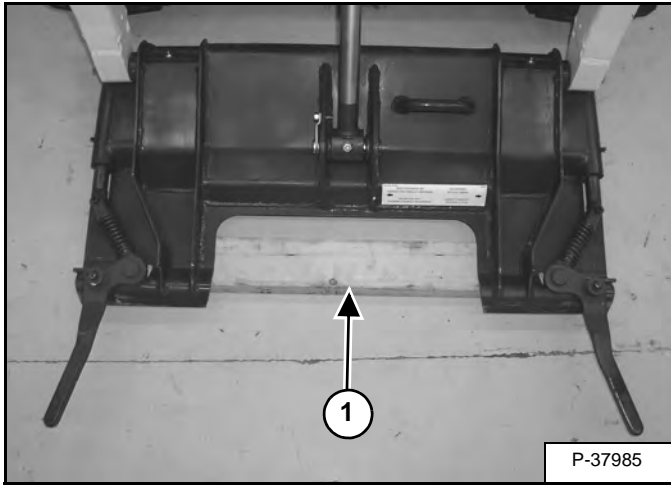

Tilt the Bob-Tach forward so it is parallel to the floor. Put blocks under the Bob-Tach and lower the Bob-Tach onto the blocks (Item 1) [Figure 50-40-1].

Figure 50-40-2

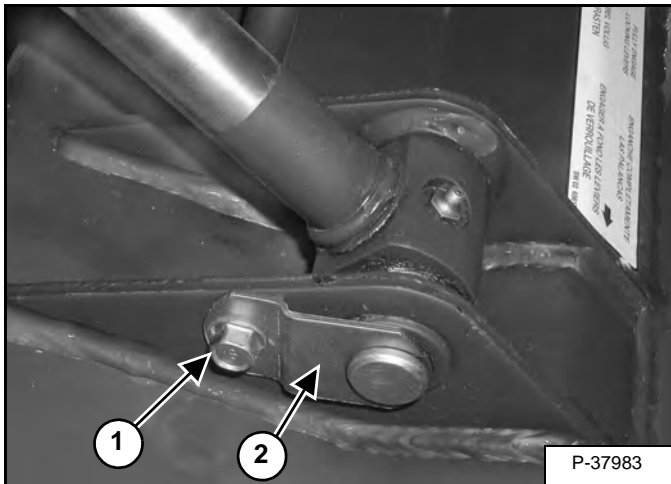

Remove the retainer bolt (Item 1) and rod end pivot pin retainer (Item 2) [Figure 50-40-2].

Installation: Tighten the retainer bolt to 24 - 27 N•m (18 - 20 ft-lb) torque.

Figure 50-40-3

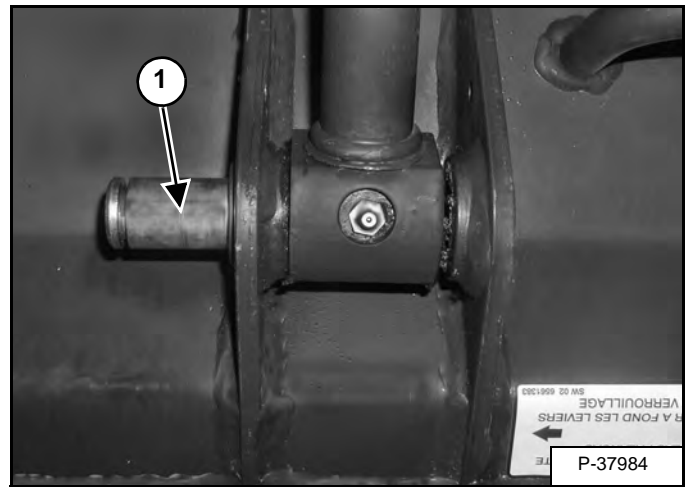

Remove the pivot pin (Item 1) [Figure 50-40-3] from the tilt cylinder and the Bob-Tach.

Figure 50-40-4

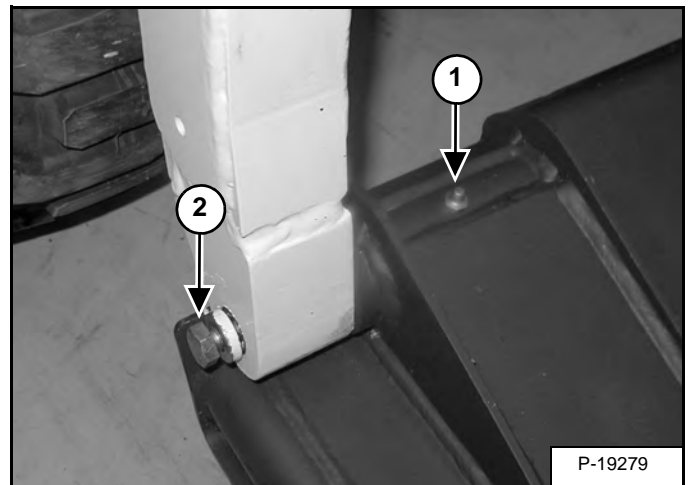

Remove the grease fitting (Item 1) and slightly loosen the bolt (Item 2) [Figure 50-40-4].

Cover the grease fitting hole with a rag and strike the pivot pin bolt with a hammer to loosen the tapered pin.

Repeat the procedure for the other side.

Installation: A longer bolt will be needed to temporarily reach through the lift arms into the pins to seat them into the lift arms. Once seated, reinstall the original bolts. Tighten the bolts to 125 - 135 N•m (90 - 100 ft-lb) torque.

Slowly back the loader away to remove the Bob-Tach frame.

BOB-TACH (CONT'D)

Removal And Installation (Cont'd)

Figure 50-40-5

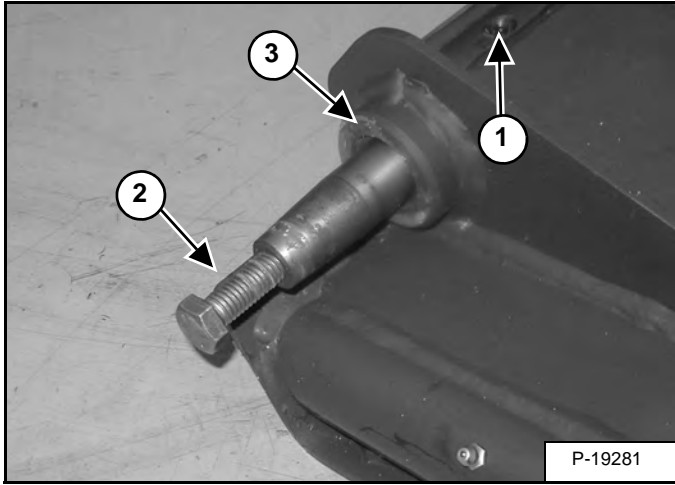

Remove the grease fitting from the pivot pin grease chamber (Item 1) [Figure 50-40-5].

Install the Bob-Tach mounting bolt (Item 2) [Figure 50-40-5] in the pivot pin and remove the pivot pin.

Inspect for wear and damage. Replace the pivot pins as needed.

Installation: Push the pivot pin into the Bob-Tach frame. Position the end of the pin flush with the end of the Bob-Tach bushing (Item 3) [Figure 50-40-5].

Figure 50-40-6

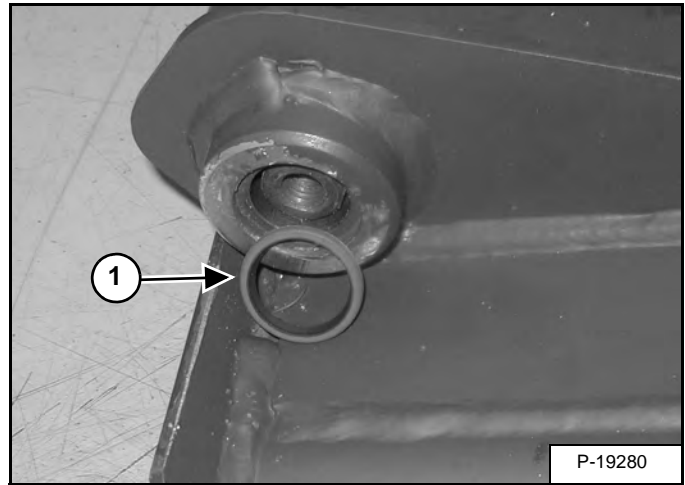

Remove the seal (Item 1) [Figure 50-40-6] from the Bob-Tach. Inspect the condition of the seal and replace as needed.

NOTE: Install the seal with the lip facing outward.

NOTE: There is a plug located at the bottom of the bore in each Bob-Tach bushing. The plug helps contain the grease inside the bushing and is a very low service item. See your dealer if service is required.

Reverse the removal procedure to install the Bob-Tach.

BOB-TACH (CONT'D)

Lever And Wedge Disassembly And Assembly

Use the following procedure to remove and install the Bob-Tach lever, spring, and wedge.

Figure 50-40-7

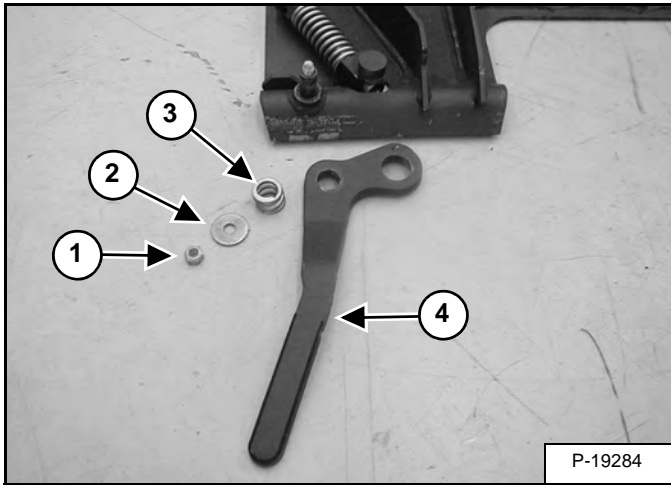

Remove the lever mounting bolt and nut (Item 1), washer (Item 2), spring (Item 3) and lever (Item 4) [Figure 50-40-7].

Figure 50-40-8

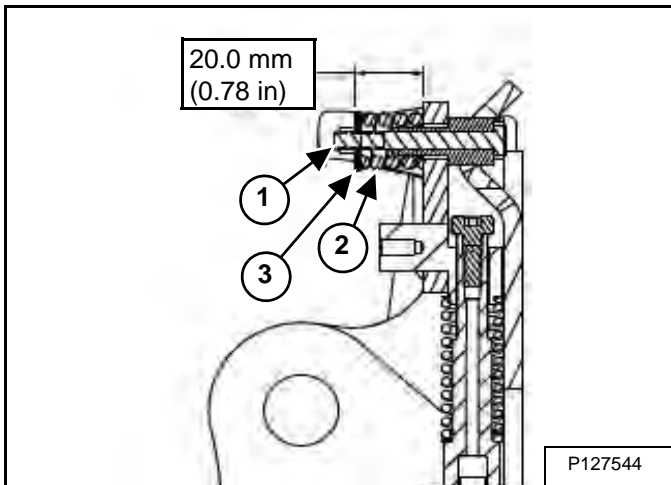

Installation: Tighten the nut (Item 1) until the spring (Item 2) and washer (Item 3) [Figure 50-40-8] are compressed to 20.0 mm (0.78 in).

Figure 50-40-9

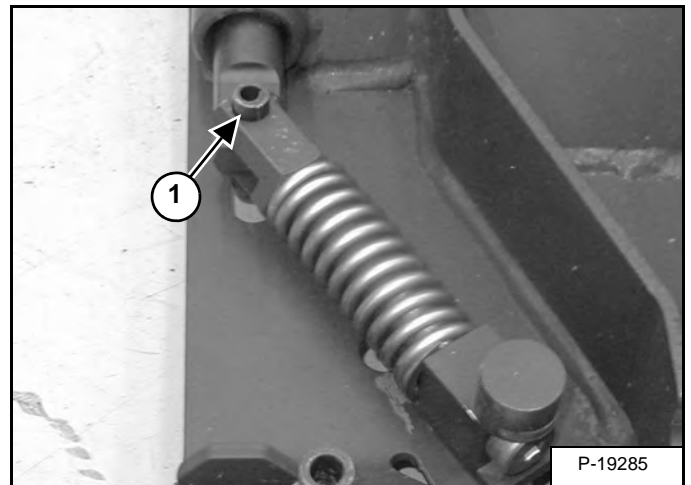

Use a punch and hammer, remove the roll pin (Item 1) [Figure 50-40-9] from the Bob-Tach wedge and spring, bolt, and clevis assembly.

Figure 50-40-10

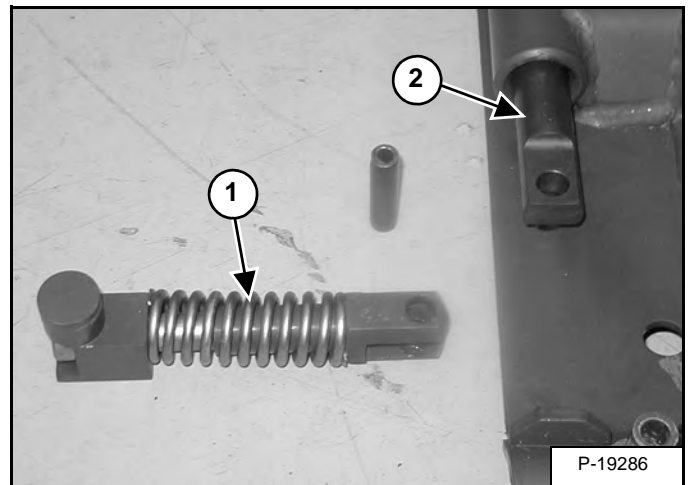

Remove the spring, bolts, and clevis assembly (Item 1) [Figure 50-40-10].

Remove the wedge (Item 2) [Figure 50-40-10] from the Bob-Tach frame.

Always replace bent or broken wedges.

BOB-TACH (CONT'D)

Lever And Wedge Disassembly And Assembly (Cont'd)

Earlier Design

Figure 50-40-11

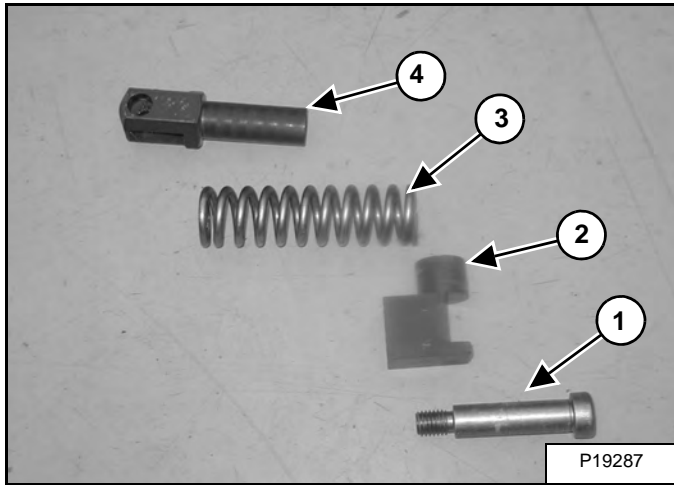

If the bolt (Item 1), handle pivot (Item 2), spring (Item 3), or clevis (Item 4) are damaged, put the assembly in a vise. Loosen and remove the bolt (Item 1) [Figure 50-40-11]. Replace the worn or damaged parts as needed.

Assembly: Clean the threads and apply Loctite® 242 to the bolt (Item 1) [Figure 50-40-11], tighten to 125 - 135 N•m (90 - 100 ft-lb) torque.

Later Design

Figure 50-40-12

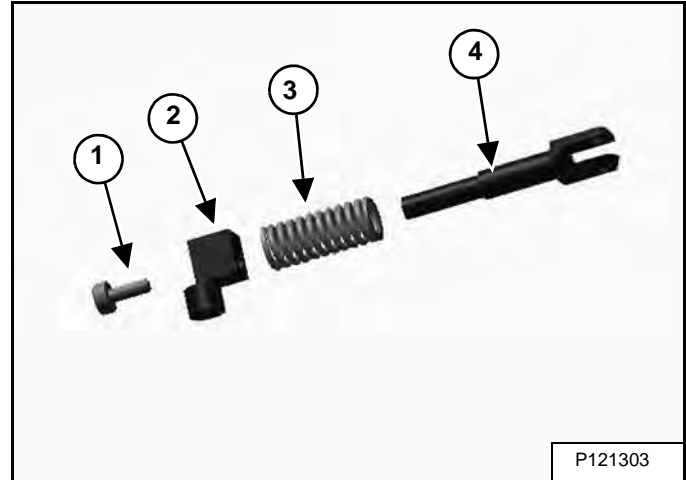

If the bolt (Item 1), handle pivot (Item 2), spring (Item 3), or clevis (Item 4) are damaged, put the assembly in a vise. Loosen and remove the bolt (Item 1) [Figure 50-40-12]. Replace the worn or damaged parts as needed.

Assembly: Clean the threads and apply Loctite® 242 to the bolt (Item 1) [Figure 50-40-12], tighten to 48 - 54 N•m (35 - 40 ft-lb) torque.

Reverse the removal procedure to install the Bob-Tach Lever and Wedge.

LIFT ARMS

Removal And Installation

Figure 50-50-1

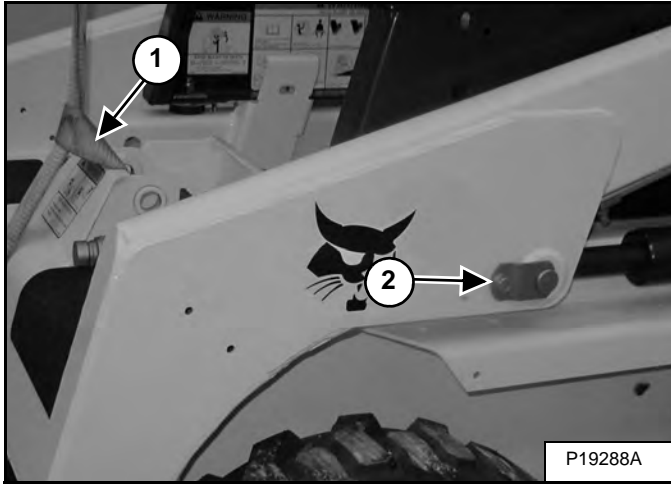

Put jackstands under the front and rear corner of the loader. (See Procedure on Page 10-10-1.)

Remove the Bob-Tach. (See Removal And Installation on Page 50-40-1.)

Start the engine and raise the lift arms to allow jackstands to be placed under the lift arm crossmember. Have a second person install the jackstands. Lower the lift arms until the lift arms rest on the jackstands. Stop the engine.

Install a sling (Item 1) [Figure 50-50-1] around the lift arm crossmember and use a chain hoist to support the lift arms.

Remove the tilt cylinder. (See Removal And Installation on Page 20-21-2.)

Remove the bolt (Item 2) [Figure 50-50-1] from the rod end pivot pin retainer on the left lift cylinder. Remove the retainer and the pivot pin.

Lower the cylinder to the fender.

Figure 50-50-2

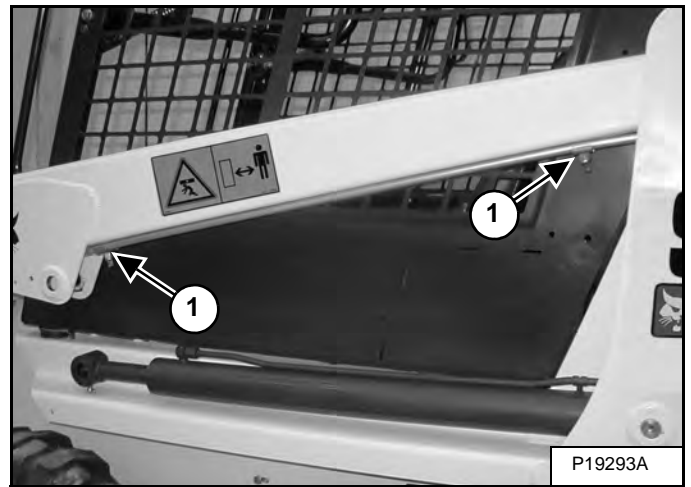

Remove the auxiliary tubeline clamps (Item 1) [Figure 50-50-2] (if equipped).

Use caps and plugs in the fittings during the procedure.

Figure 50-50-3

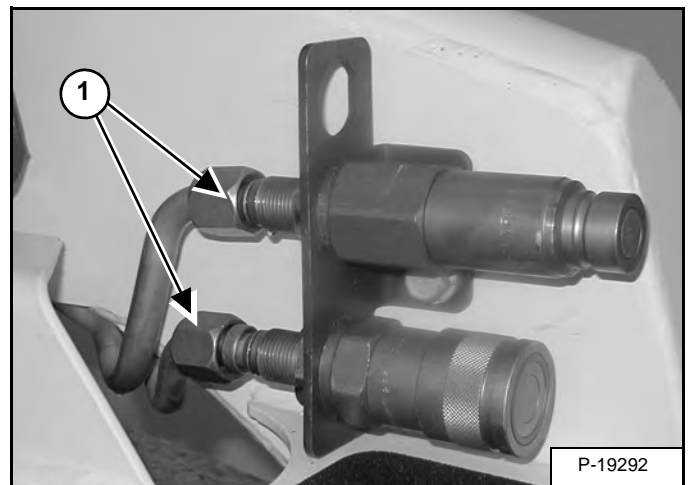

Remove the auxiliary tubelines (Item 1) [Figure 50-50-3] from the auxiliary coupler bulkhead fittings.

LIFT ARMS (CONT'D)

Removal And Installation (Cont'd)

Figure 50-50-4

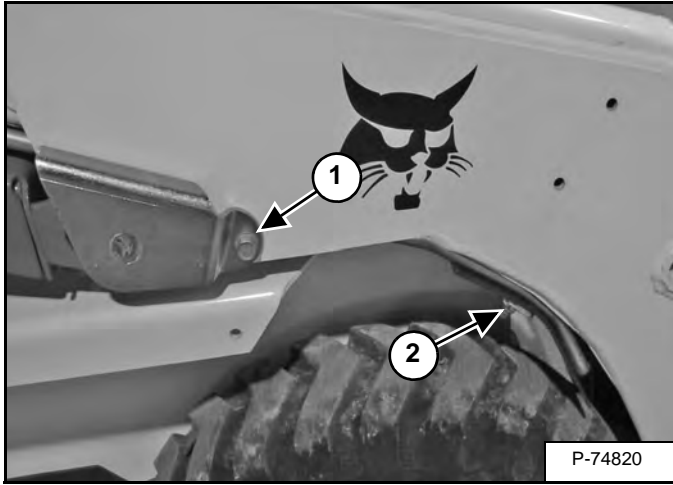

Remove the rod end pivot pin bolt (Item 1) [Figure 50-50-4] from the right lift cylinder. Remove the pivot pin.

Lower the cylinder to the fender.

Remove the nut (Item 2) [Figure 50-50-4] from the tilt cylinder tubeline cover.

Remove the tubeline clamps from the right lift arm.

Figure 50-50-5



Wrap the lifting strap around the lift arm as shown [Figure 50-50-5] (both sides) and attach it to the chain hoist.

Figure 50-50-6

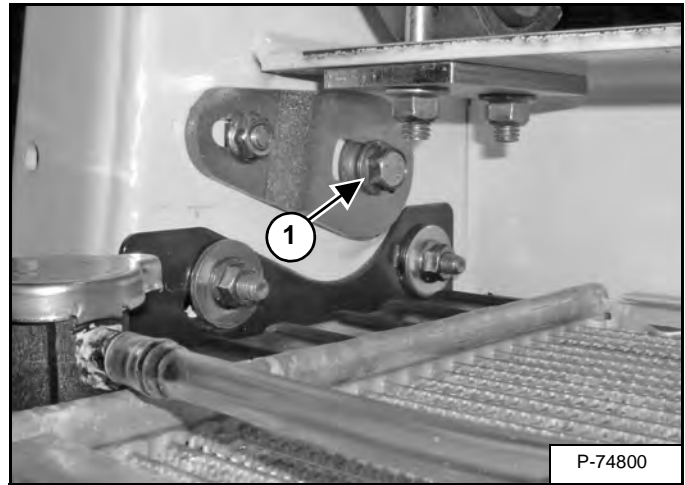

Remove the bolt (Item 1) [Figure 50-50-6] from the upright pivot pin (both sides).

Figure 50-50-7



Use a slide hammer to remove the pivot pin from the upright (both sides) [Figure 50-50-7].

LIFT ARMS (CONT'D)

Removal And Installation (Cont'd)

Figure 50-50-8



Use the chain hoist to remove the lift arms from the loader [Figure 50-50-8].

Use the reverse procedure to install the lift arms on the loader.



Bobcat®

REAR DOOR

Removal And Installation

Open the rear door.

Figure 50-60-1

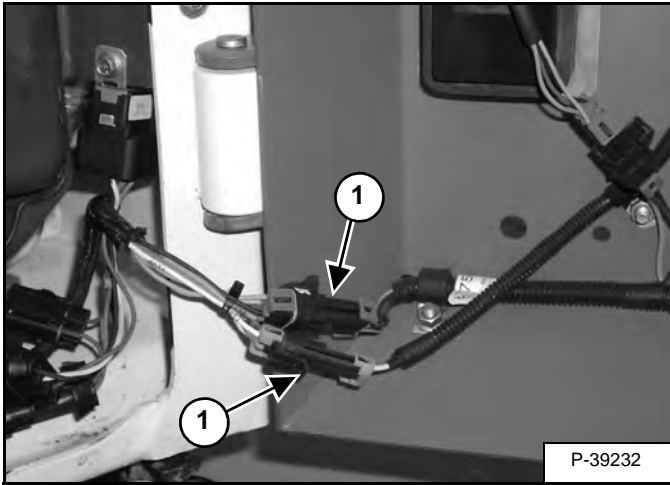

Disconnect the wire harnesses (Item 1) [Figure 50-60-1] from the loader electrical harness.

Figure 50-60-2

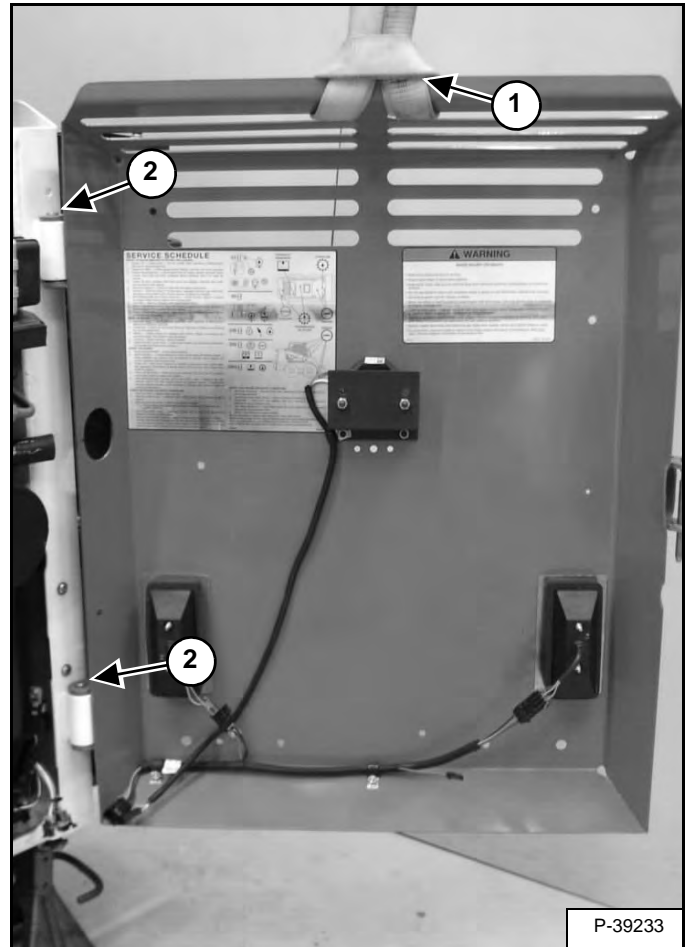

Install a lifting strap (Item 1) [Figure 50-60-2] through the slots in the rear door.

Remove the hinge pins (Item 2) [Figure 50-60-2] from the door hinges.

Remove the door from the loader.



Bobcat®

FUEL TANK

Removal And Installation

Put jackstands under the rear corners of the loader. (See Procedure on Page 10-10-1.)

Raise the operator cab. (See Raising on Page 10-30-2.)

Figure 50-70-1

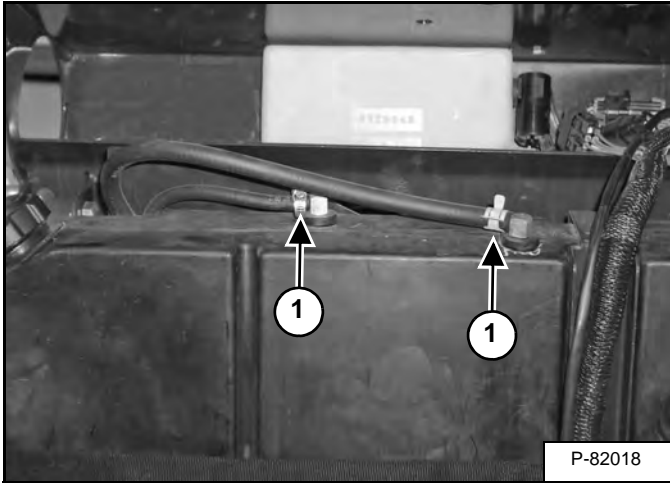

Remove the hose clamps (Item 1) [Figure 50-70-1] to remove the fuel supply and return lines.

Figure 50-70-2

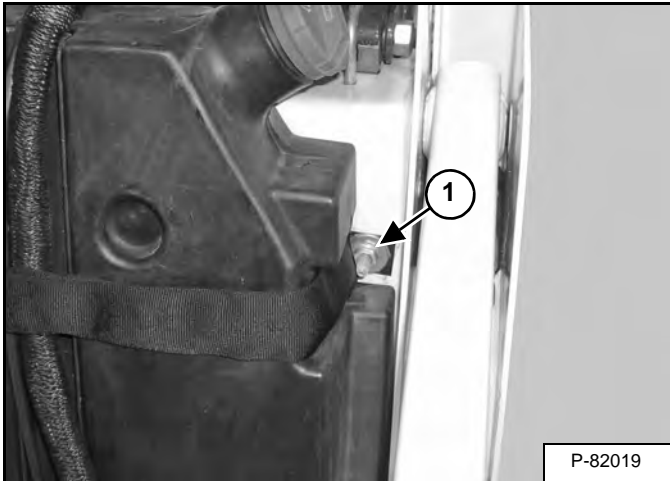

Remove the nut (Item 1) [Figure 50-70-2] from the fuel tank mounting strap.

Figure 50-70-3

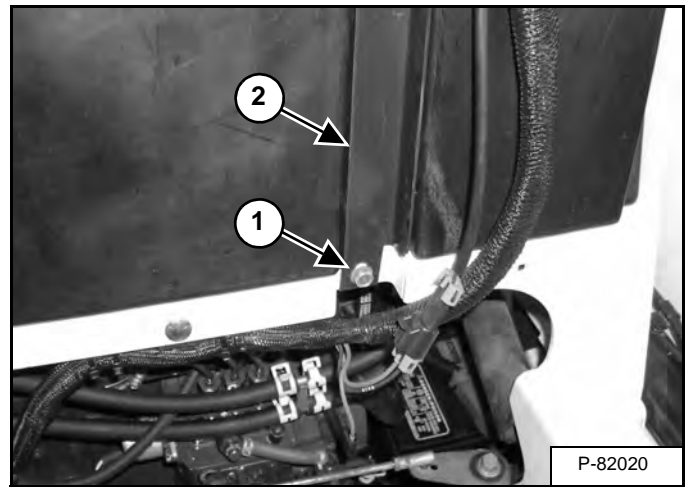

Remove the bolt (Item 1) and bracket (Item 2) [Figure 50-70-3].

Remove the fuel tank from the loader.



Bobcat®

CONTROL PEDALS AND LINKAGES

Description

The control pedals and linkages are connected to the control valve. The control pedals will mechanically move the lift and tilt spools on the control valve.

The control pedals and linkages are located on the lower mainframe at the operator's feet.

Pedal Removal And Installation



P-90328

AVOID DEATH

- Disconnecting or loosening any hydraulic tubeline, hose, fitting, component or a part failure can cause lift arms to drop.
- Keep out of this area when lift arms are raised unless supported by an approved lift arm support. Replace if damaged.

D-1009-0409



Never work on a machine with the lift arms up unless the lift arms are secured by an approved lift arm support device. Failure to use an approved lift arm support device can allow the lift arms or attachment to fall and cause injury or death.

W-2059-0598

Put jackstands under the rear of the loader. (See Procedure on Page 10-10-1.)

Raise the loader arms and install the lift arm support device. (See Installing on Page 10-20-1.)

Raise the operator cab. (See Raising on Page 10-30-2.)

Figure 50-80-1

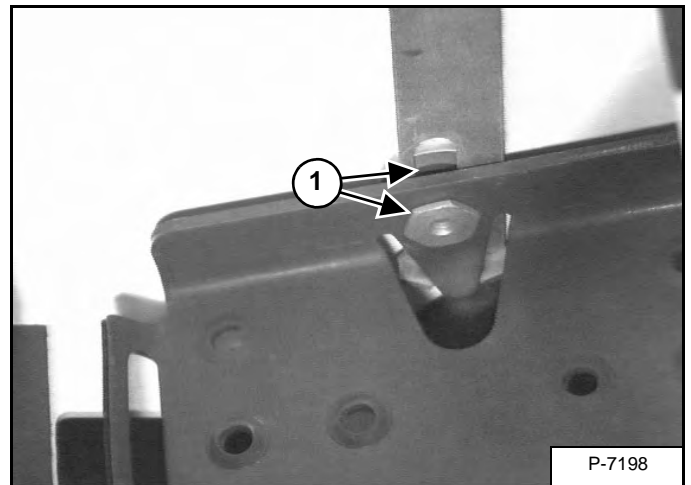
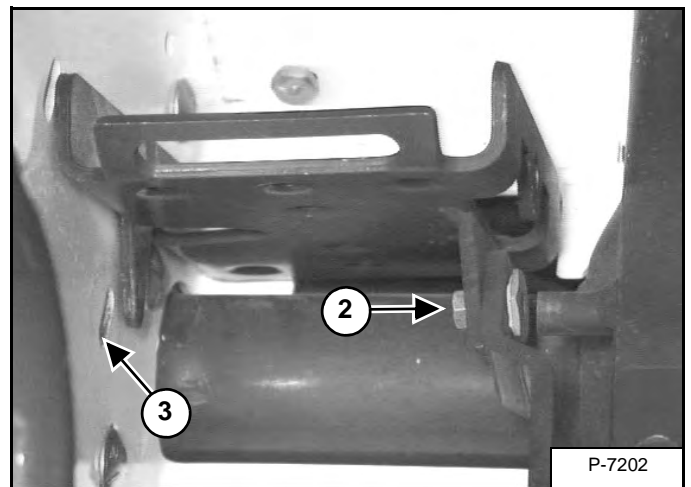

Figure 50-80-2



Remove the bottom nut, washers and bolt (Item 1) [Figure 50-80-1] from the interlock and pedal.

Remove the bolt (Item 2) [Figure 50-80-2] from the linkage pivot.

Installation: When installing the pedal and interlock, align them by moving the interlock forward or backward in the slot (Item 3) [Figure 50-80-2] in the fender.

Remove the pedal from the linkage.

CONTROL PEDALS AND LINKAGES (CONT'D)

Pedal Interlock Linkage Removal And Installation

Figure 50-80-3

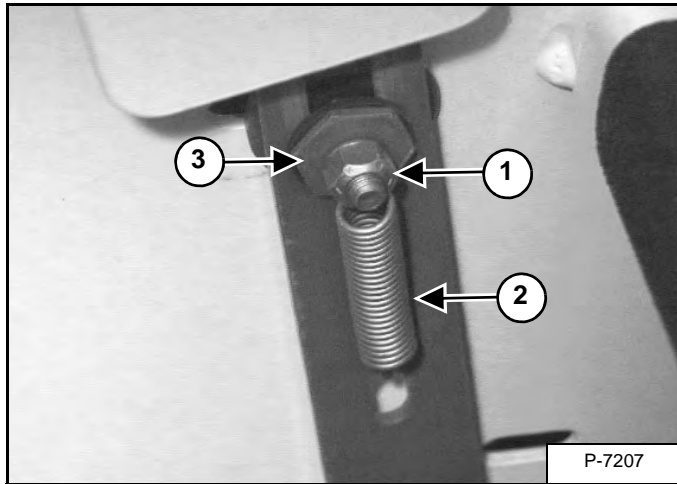

Remove the nut (Item 1) [Figure 50-80-3] from the top bolt on the interlock.

Remove the spring (Item 2) [Figure 50-80-3] from the bolt and interlock.

Installation: Tighten the interlock nut to 9 - 10 N•m (80 - 90 in-lb) torque.

Remove the nut (Item 3) [Figure 50-80-3] and plastic washer from the interlock bolt.

Remove the bolt from the outside of the fender.

NOTE: Note the location of the interlock parts during removal for assembly purposes. There is a plastic washer which must be installed on each side of the interlock bar during assembly.

Figure 50-80-4

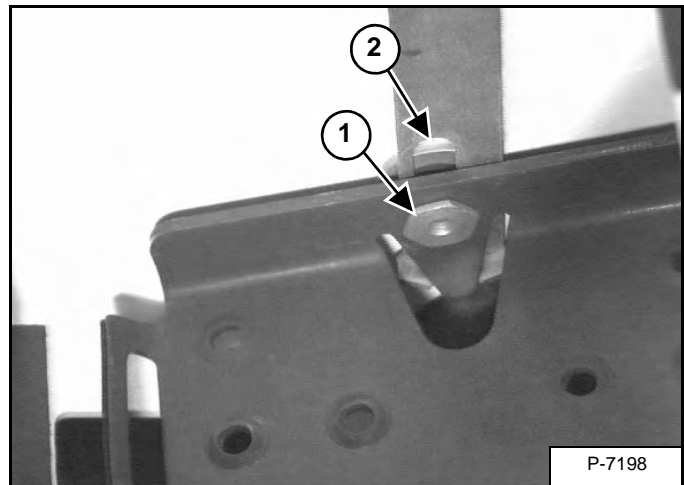

Remove the nut (Item 1) [Figure 50-80-4] from the bottom bolt on the interlock and pedal.

Always check for free movement of the interlock after assembly.

Installation: When installing the pedal and interlock, align them by moving the interlock forward or backward in the slot in the fender.

Figure 50-80-5

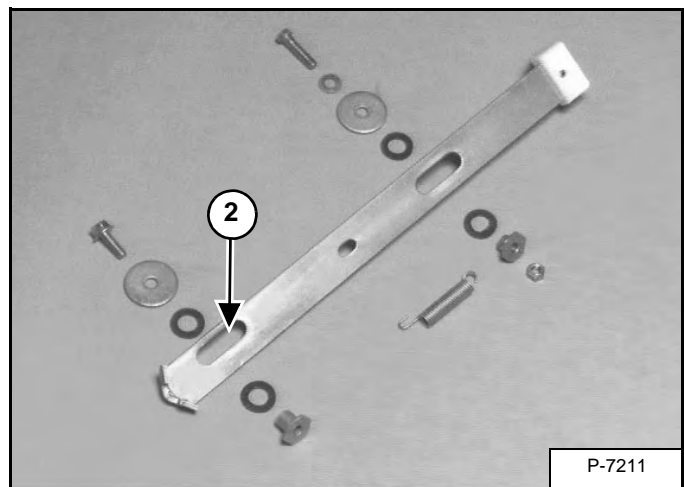

Remove the interlock assembly [Figure 50-80-5].

Installation: The bottom slot (Item 2) [Figure 50-80-4] and [Figure 50-80-5] on both interlock bars must be toward the rear of the pedal.

CONTROL PANEL

Description

The control panel consists of a center shield and two side lever panels. The side lever panels have rubber boots which cover the openings for the levers.

Control Shield And Steering Lever Panels Removal And Installation

WARNING

Put jackstands under the front axles and rear corners of the frame before running the engine for service. Failure to use jackstands can allow the machine to fall or move and cause injury or death.

W-2017-0286

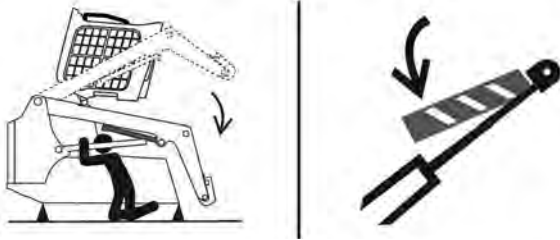

P-90328

AVOID DEATH

- Disconnecting or loosening any hydraulic tubeline, hose, fitting, component or a part failure can cause lift arms to drop.
- Keep out of this area when lift arms are raised unless supported by an approved lift arm support. Replace if damaged.

D-1009-0409

WARNING

Never work on a machine with the lift arms up unless the lift arms are secured by an approved lift arm support device. Failure to use an approved lift arm support device can allow the lift arms or attachment to fall and cause injury or death.

W-2059-0598

Put jackstands under the rear of the loader. (See Procedure on Page 10-10-1.)

Raise the loader arms and install the lift arm support device. (See Installing on Page 10-20-1.)

Raise the operator cab. (See Raising on Page 10-30-2.)

Figure 50-90-1

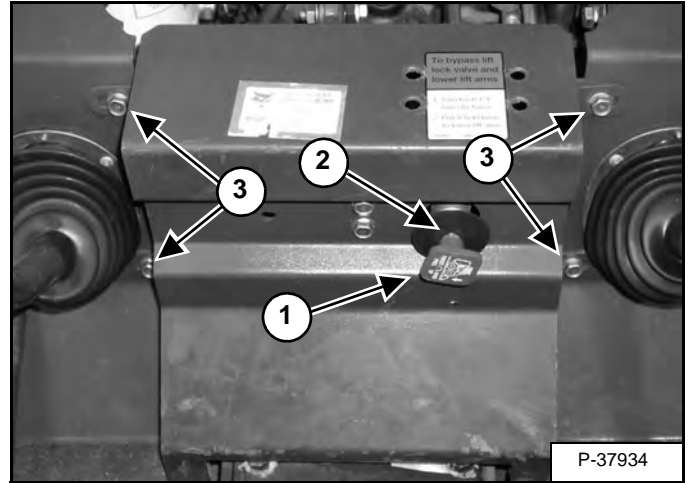

Hold the locknut and remove the lift arm bypass knob (Item 1) [Figure 50-90-1].

Remove the locknut and rubber washer (Item 2) [Figure 50-90-1] from the BICS™ valve block.

Remove the four mounting bolts (Item 3) [Figure 50-90-1] from the control shield.

Remove the control shield.

Figure 50-90-2

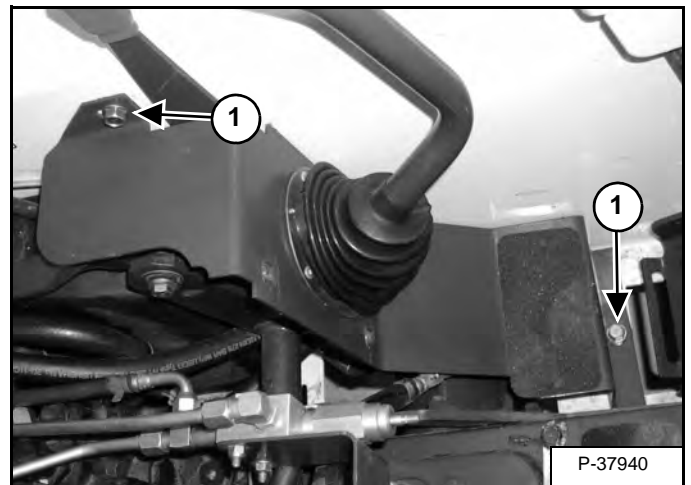

Remove the two bolts (Item 1) [Figure 50-90-2] from the steering lever panels. Remove the panels.



Bobcat®

CONTROL LEVER

Description

The control handles / levers are used to control the forward and reverse travel.

The control handles / levers are mounted to the frame.

Lever Removal And Installation

WARNING

Put jackstands under the front axles and rear corners of the frame before running the engine for service. Failure to use jackstands can allow the machine to fall or move and cause injury or death.

W-2017-0286

WARNING

Never work on a machine with the lift arms up unless the lift arms are secured by an approved lift arm support device. Failure to use an approved lift arm support device can allow the lift arms or attachment to fall and cause injury or death.

W-2059-0598

Raise the loader arms and install the lift arm support device. (See Installing on Page 10-20-1.)

Raise the operator cab. (See Raising on Page 10-30-2.)

Remove the control shield and steering panels. (See Control Shield And Steering Lever Panels Removal And Installation on Page 50-90-1.)

Figure 50-100-1

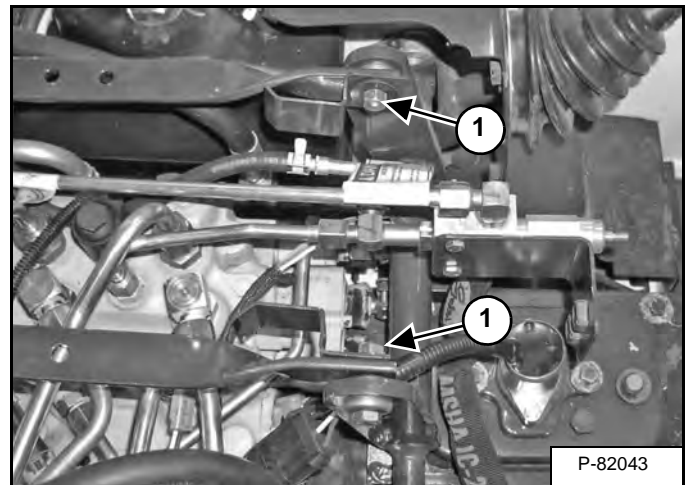

Remove the nuts and bolts (Item 1) [Figure 50-100-1] from the steering linkage.

Figure 50-100-2

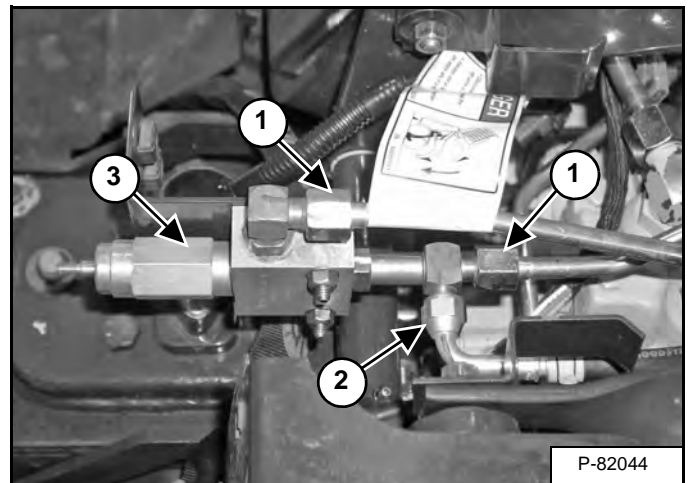

Disconnect the tubelines (Items 1) and the hose (Item 2) from the lift arm bypass valve assembly (Item 3) [Figure 50-100-2].

Remove the lift arm bypass valve assembly.

CONTROL LEVER (CONT'D)

Lever Removal And Installation (Cont'd)

Figure 50-100-3

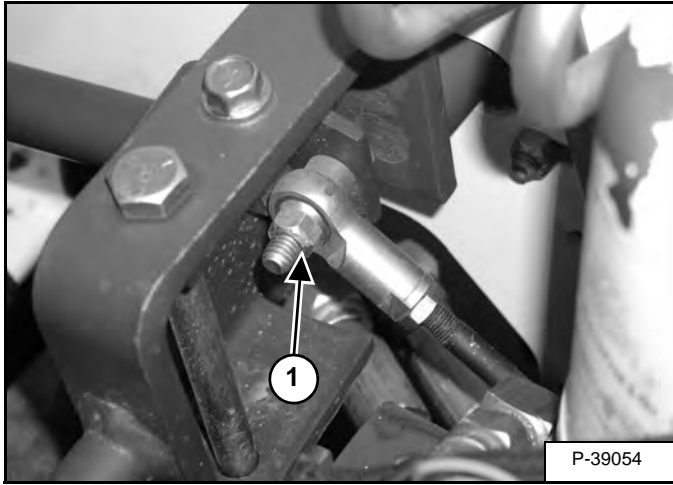

Remove the nut (Item 1) [Figure 50-100-3] from the auxiliary hydraulics cable bolt (if equipped).

Remove the cable.

Figure 50-100-4

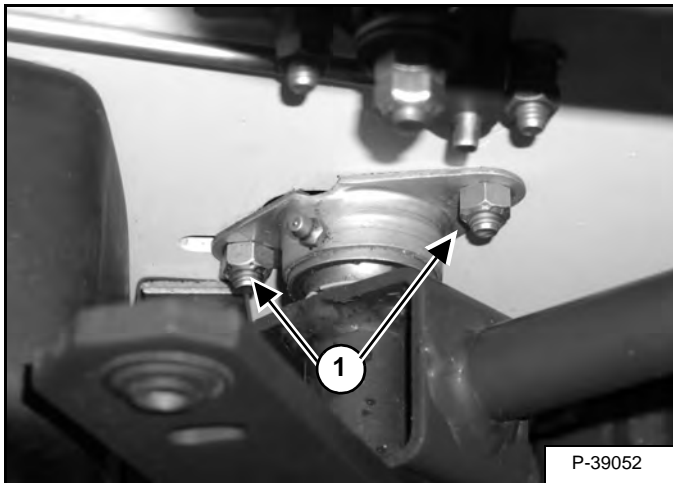

Remove the nuts (Item 1) [Figure 50-100-4] from the pivot bearings (right side). Hold the bolts from outside the fender.

Figure 50-100-5

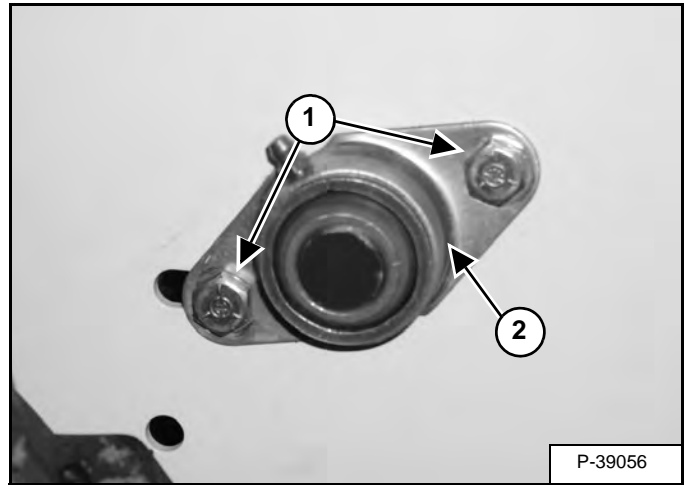

Remove the bolts (Item 1) [Figure 50-100-5] from the pivot bearings (right side). Hold the nuts from inside the fender.

Remove the bearing (Item 2) [Figure 50-100-5].

Figure 50-100-6

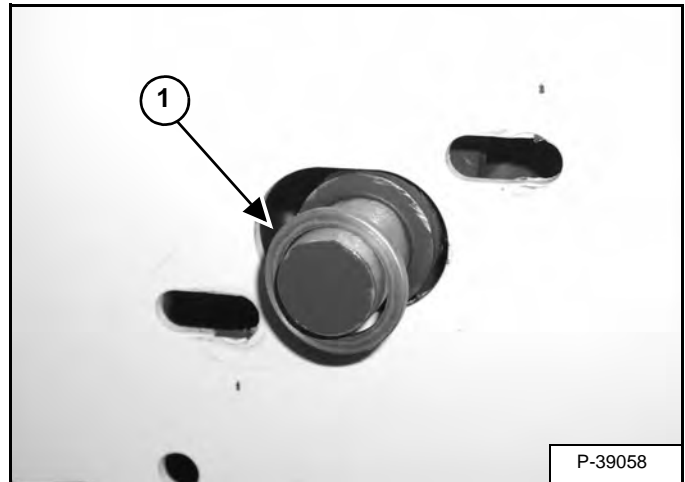

When removing the right side bearing, watch for shims (Item 1) [Figure 50-100-6]. Remove the shims.

Remove the steering lever assembly from the loader.

CONTROL LEVER (CONT'D)

Lever Disassembly And Assembly

Figure 50-100-7

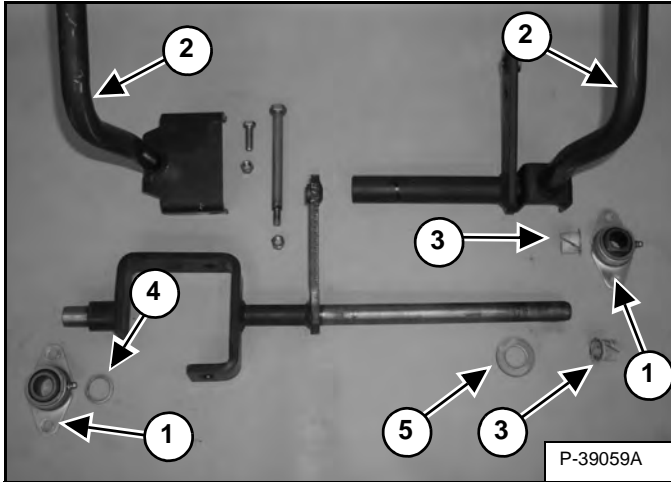

Remove the bearings (Item 1) [Figure 50-100-7] from the shaft.

Remove the steering levers (Item 2) [Figure 50-100-7] from the shaft.

Inspect the plastic bushings (Item 3), shims (Item 4) and the washers (Item 5) [Figure 50-100-7] for damage or wear and replace as necessary.

Assembly: Lightly lubricate the steering shaft during assembly.

WARNING

Put jackstands under the front axles and rear corners of the frame before running the engine for service. Failure to use jackstands can allow the machine to fall or move and cause injury or death.

W-2017-0286

CONTROL LEVER (CONT'D)

Linkage Neutral Adjustment

Lift and block the loader. (See Procedure on Page 10-10-1.)

Raise the operator cab. (See Raising on Page 10-30-2.)

Install the Remote Start Switch. (See Remote Start Procedure on Page 10-60-3.) Start the engine and run at a slow rpm.

Figure 50-100-8

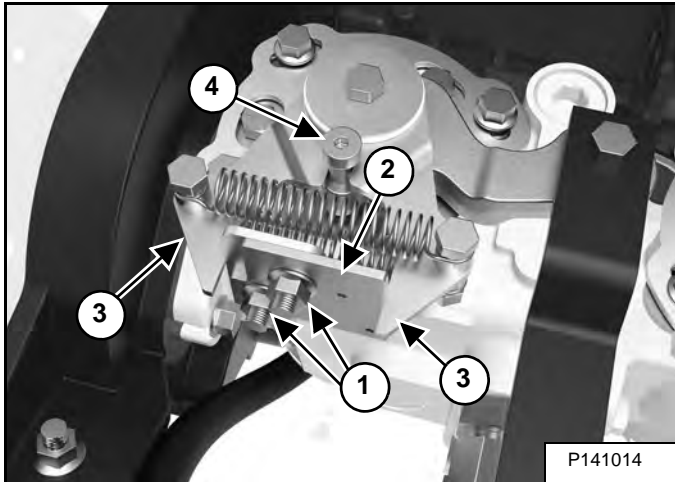

Loosen the nuts (Item 1) and slide the plate (Item 2) tight against both spring levers (Item 3) [Figure 50-100-8].

Tighten the nuts (Item 1) [Figure 50-100-8].

NOTE: The plate eliminates any free movement of the spring levers.

NOTE: The shoulder bolt (Item 4) [Figure 50-100-8] must remain torqued to 20 - 23 N•m (15 - 17 ft-lb) to avoid machine creep.

Figure 50-100-9

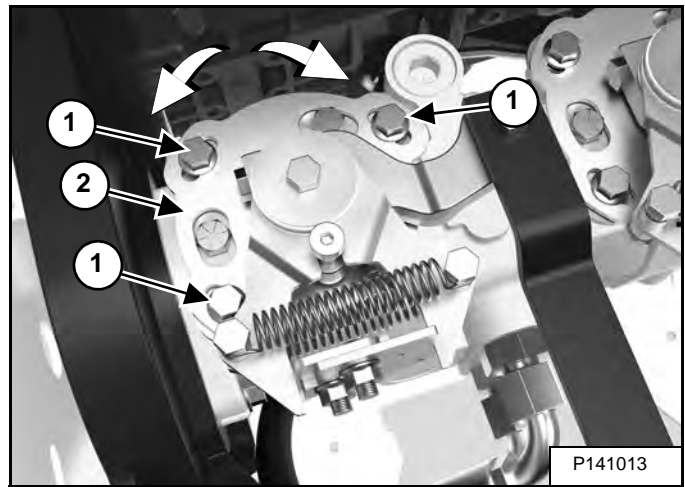

Loosen the three bolts (Item 1) [Figure 50-100-9].

Rotate the plate (Item 2) [Figure 50-100-9] in either direction until the wheels stop turning.

Tighten the three bolts (Item 1) [Figure 50-100-9].

Move the steering lever forward and backward and let the transmission return to neutral position. If the transmission does not return to the neutral position, repeat the adjustment.

Repeat steps for the other side.

Turn off the engine.

Lower the operator cab. (See Lowering on Page 10-30-3.)

Remove the jackstands from the loader frame.

CONTROL LEVER (CONT'D)

Pintle Arm Removal

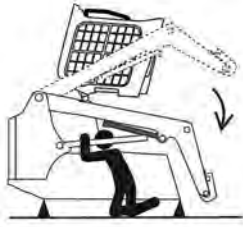

P-90328

AVOID DEATH

- Disconnecting or loosening any hydraulic tubeline, hose, fitting, component or a part failure can cause lift arms to drop.
- Keep out of this area when lift arms are raised unless supported by an approved lift arm support. Replace if damaged.

D-1009-0409



Never work on a machine with the lift arms up unless the lift arms are secured by an approved lift arm support device. Failure to use an approved lift arm support device can allow the lift arms or attachment to fall and cause injury or death.

W-2059-0598

Put jackstands under the rear of the frame. (See Procedure on Page 10-10-1.)

Raise the lift arms and install the lift arm support device. (See Installing on Page 10-20-1.)

Raise the operator cab. (See Raising on Page 10-30-2.)

Figure 50-100-10

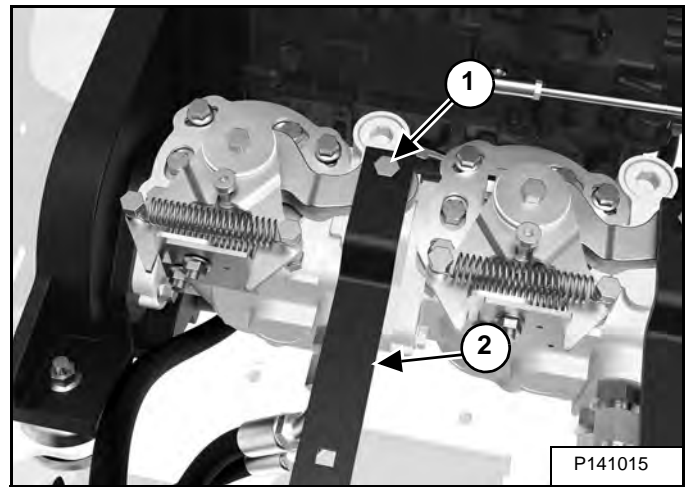

Remove the bolt and nut (Item 1) [Figure 50-100-10].

Move the steering lever (Item 2) [Figure 50-100-10] out of the way.

Figure 50-100-11

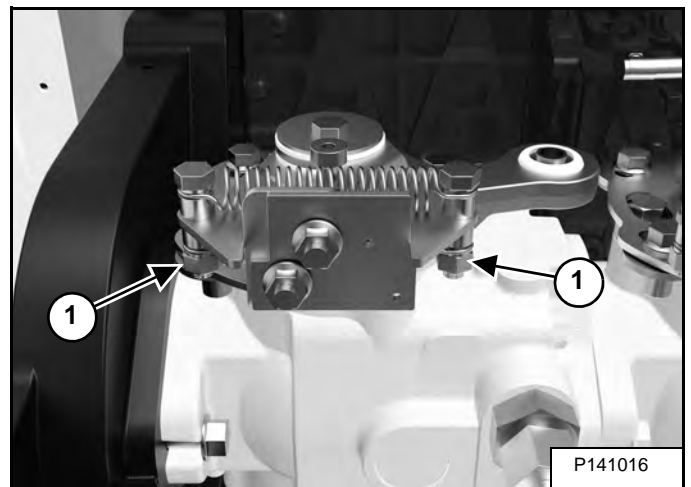

Remove the two nuts (Item 1) [Figure 50-100-11] from the shoulder bolts.

CONTROL LEVER (CONT'D)

Pintle Arm Removal (Cont'd)

Figure 50-100-12

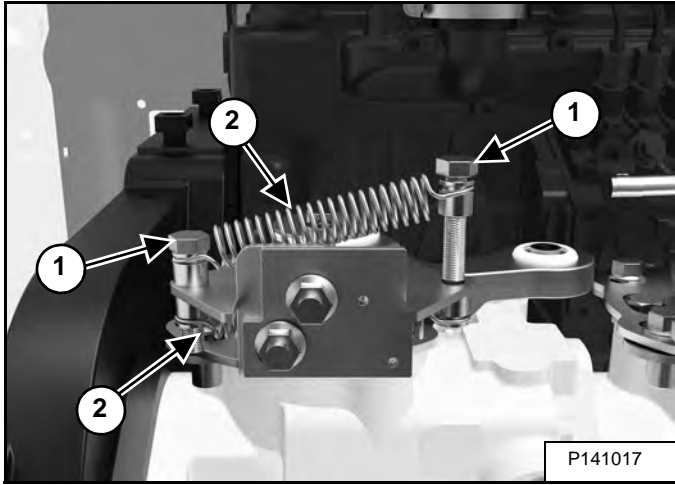

Remove the two shoulder bolts and spacers (Item 1) and springs (Item 2) [Figure 50-100-12].

Figure 50-100-13

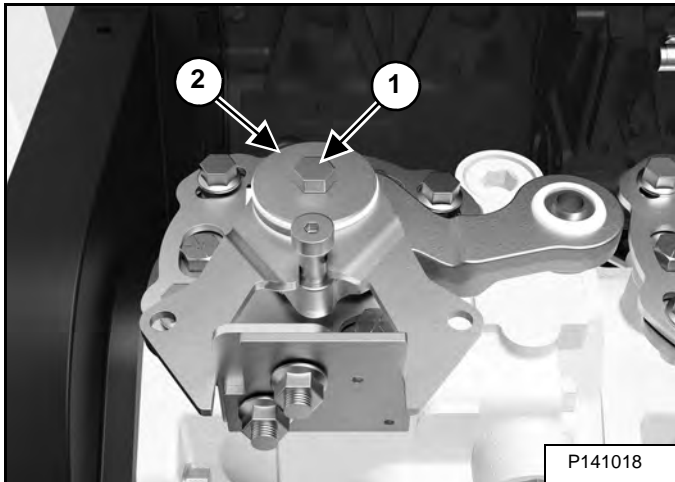

Remove the bolt (Item 1), pivot bushing (Item 2) [Figure 50-100-13].

Figure 50-100-14

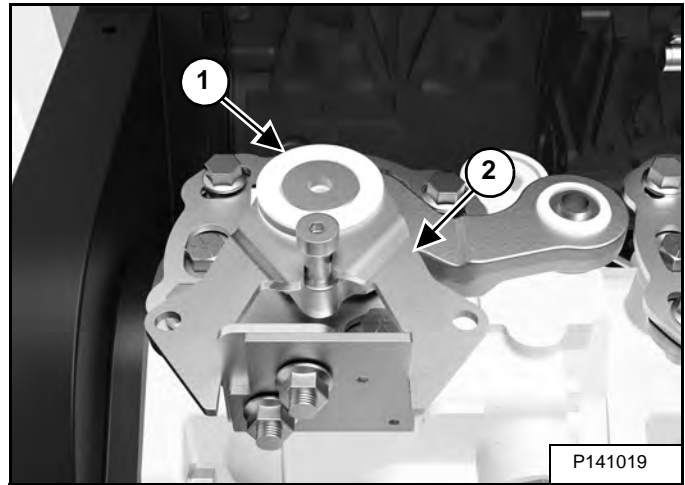

Remove the spacer (Item 1), control lever (Item 2) [Figure 50-100-14].

Figure 50-100-15

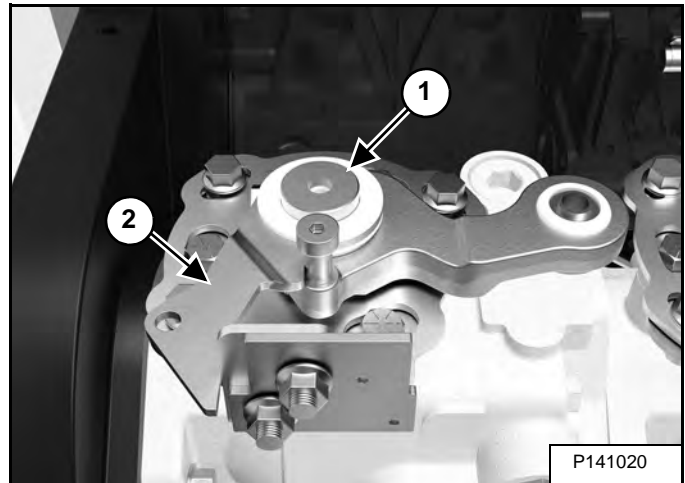

Remove the spacer (Item 1), control lever (Item 2) [Figure 50-100-15].

CONTROL LEVER (CONT'D)

Pintle Arm Removal (Cont'd)

Figure 50-100-16

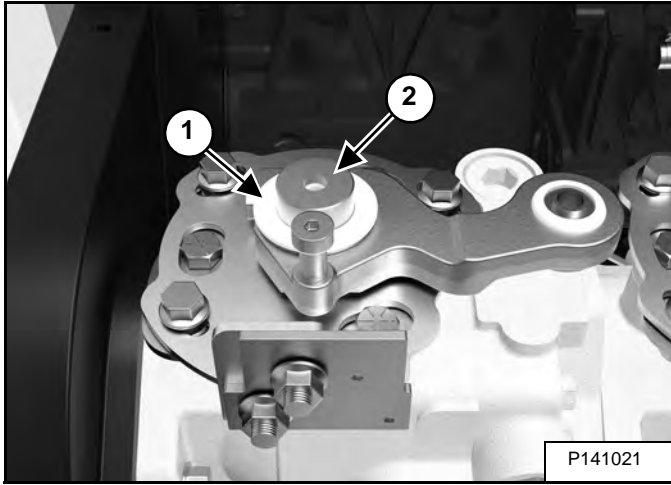

Remove the spacer (Item 1), pivot bushing (Item 2) [Figure 50-100-16].

Figure 50-100-17

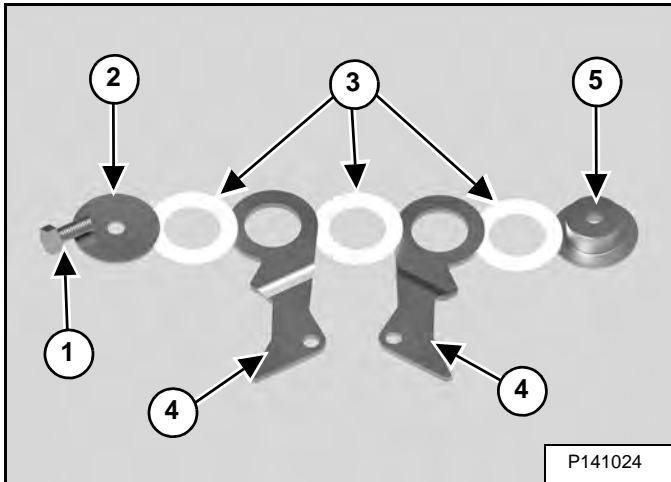

Inspect the bolt (Item 1), washer (Item 2) spacers (Item 3), spring levers (Item 4) and pivot bushing (Item 5) [Figure 50-100-17] for wear and replace as needed.

Figure 50-100-18

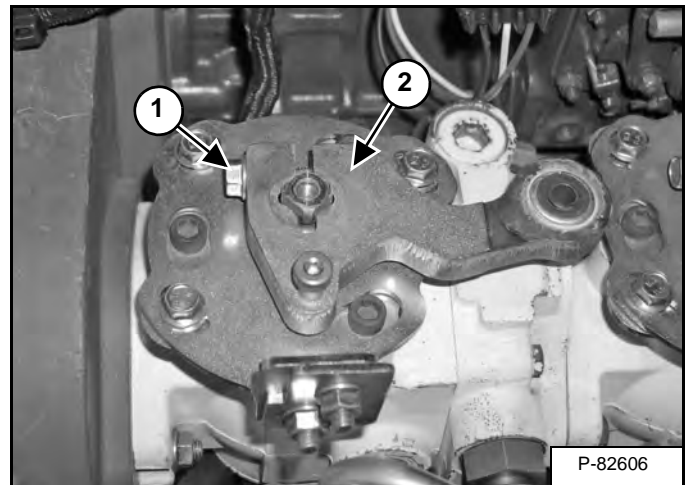

Loosen the bolt (Item 1) and remove the pintle arm (Item 2) [Figure 50-100-18] from the shaft of the hydrostatic pump.

CONTROL LEVER (CONT'D)

Pintle Arm Installation

Figure 50-100-19

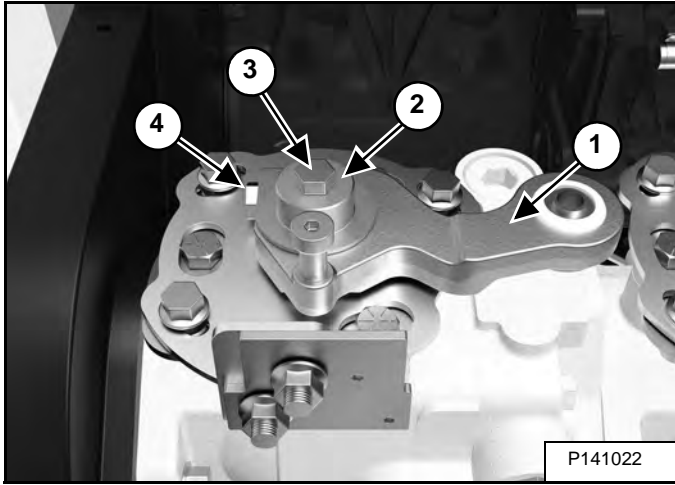

Install the pintle arm (Item 1), pivot bushing (Item 2) and bolt (Item 3) [Figure 50-100-19].

Lift the pintle arm and hold against the pivot bushing (Item 2) then tighten the bolt (Item 4) [Figure 50-100-19] to 33,9- 39,3 N•m (25 - 29 ft-lb).

Figure 50-100-20

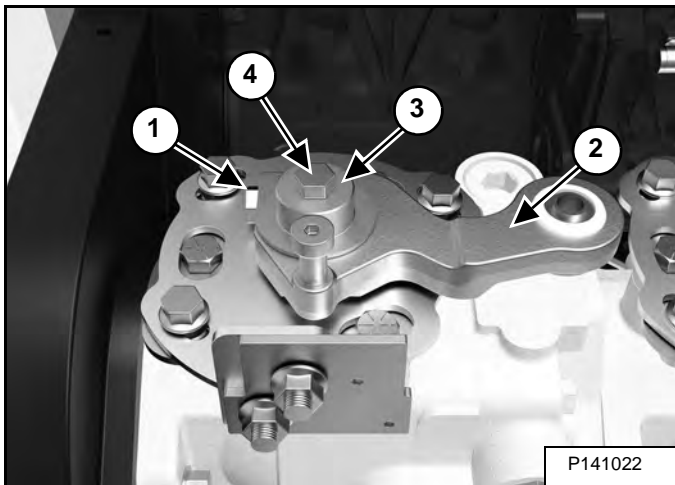

After tightening the bolt (Item 1) make sure there is full contact between the pintle arm (Item 2) and pivot bushing (Item 3) [Figure 50-100-20].

The pintle arm is now set to the proper height. Remove the pivot bushing (Item 3) and bolt (Item 4) [Figure 50-100-20].

Figure 50-100-21

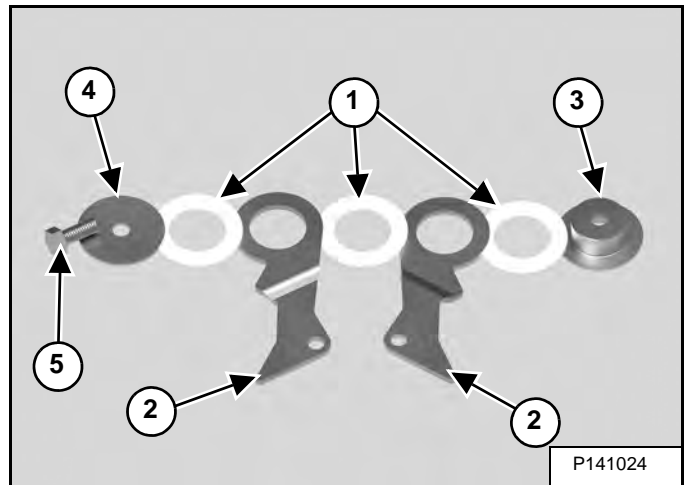

Place the spacers (Item 1) on the spring levers (Item 2) then insert the pivot bushing (Item 3) washer (Item 4) and bolt (Item 5) [Figure 50-100-21] into the assembly.

NOTE: Make sure there is Loctite® 242 or equivalent thread locker applied to the threads of the bolt (Item 5) [Figure 50-100-21] before installation.

Figure 50-100-22

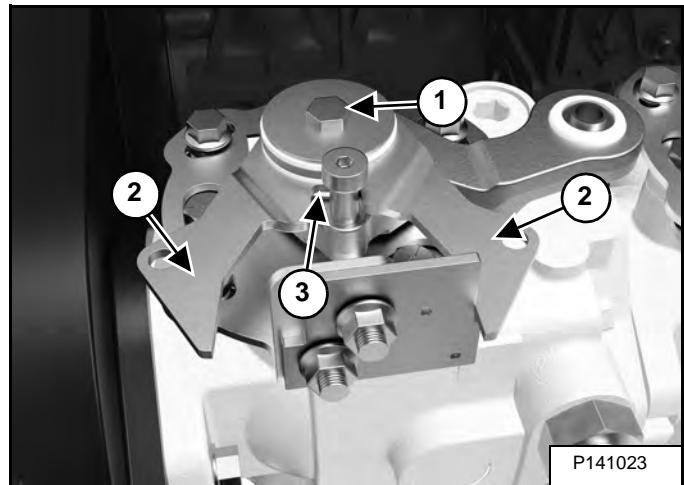

Place the spring lever and bushing assembly onto the pump shaft. Install the bolt (Item 1) [Figure 50-100-22] and tighten to 33,9 - 39,3 N•m (25 - 29 ft-lb) torque.

Check that there is free movement of the spring levers (Item 2) and the bottom spacer (Item 3) [Figure 50-100-22].

NOTE: Move the spacers with a screw driver or pick to ensure they move freely and are not pinched between the bushing and pintle arm.

CONTROL LEVER (CONT'D)

Pintle Arm Installation (Cont'd)

Figure 50-100-23

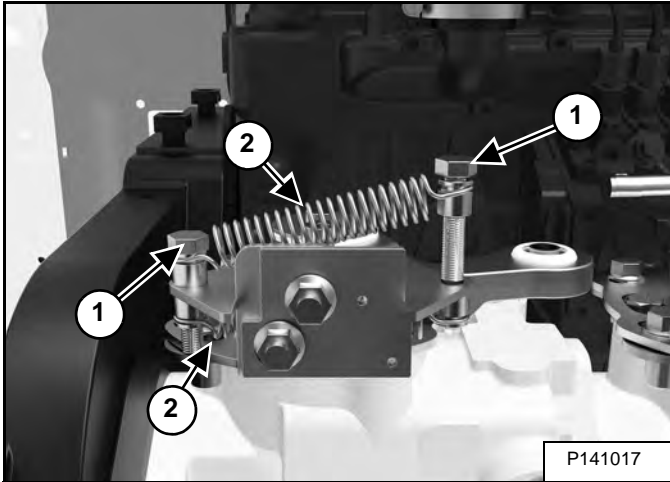

Install the two shoulder bolts and spacers (Item 1) and springs (Item 2) [Figure 50-100-23] into the spring lever.

Figure 50-100-24

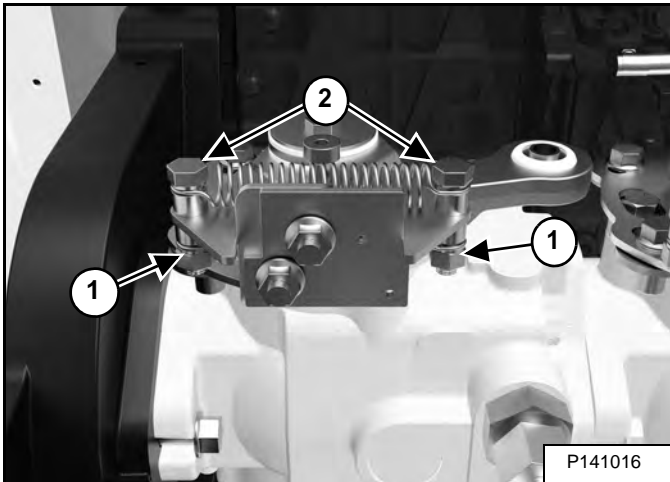

Install the nuts (Item 1) onto the shoulder bolts (Item 2) [Figure 50-100-24] and tighten.

Figure 50-100-25

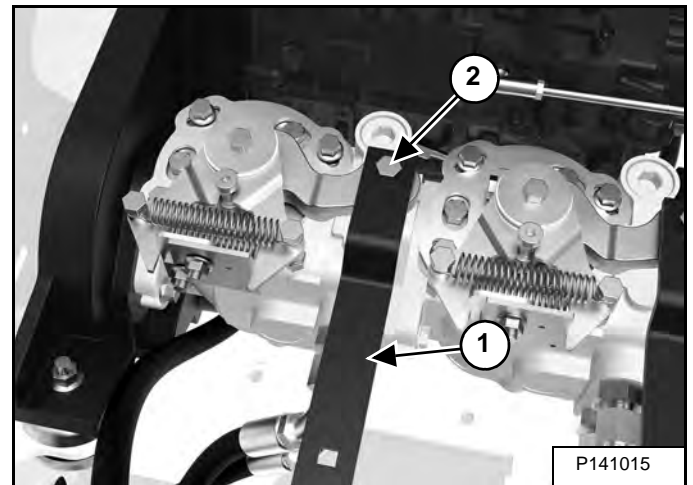

Reconnect the steering lever (Item 1) with the bolt and nut (Item 2) [Figure 50-100-25].

Adjust the steering linkage if needed. (See Linkage Neutral Adjustment on Page 50-100-4.)

CONTROL LEVER (CONT'D)

Pintle Arm Disassembly And Assembly

Figure 50-100-26

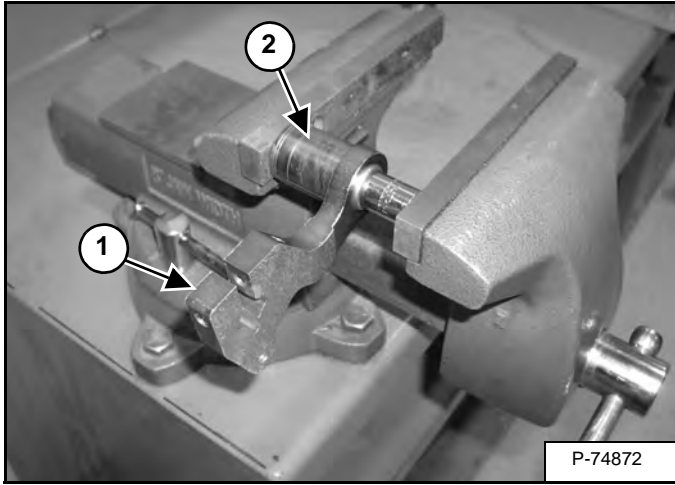

Place the pintle arm (Item 1) between a large and small socket and place in a vise. Press the bushing from the pintle arm and into the opening of the large socket (Item 2) [Figure 50-100-26].

Replace the bushing if damaged.

Figure 50-100-27

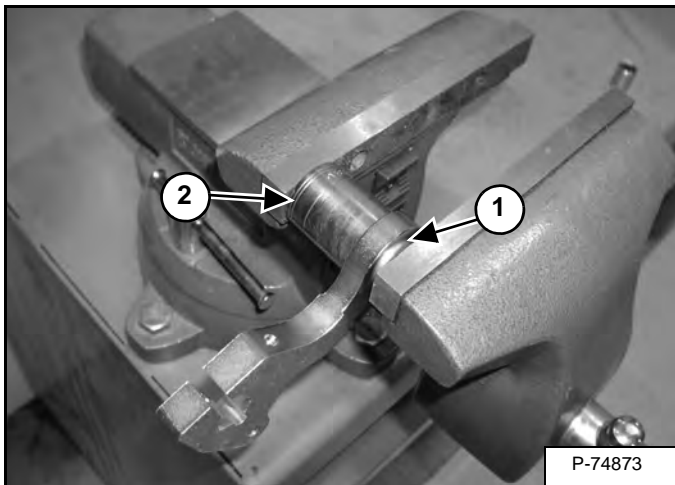

Press the bushing (Item 1) into the pintle arm by placing the open end of a large socket (Item 2) [Figure 50-100-27] against one side of the pintle arm.

Figure 50-100-28

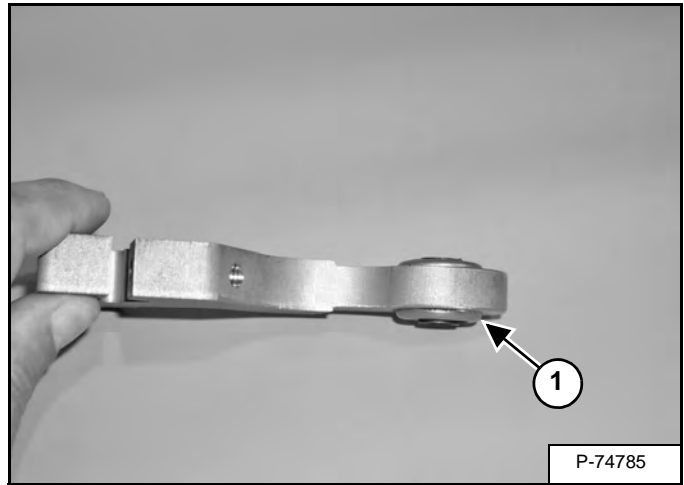

Make sure an equal amount of bushing (Item 1) [Figure 50-100-28] protrudes from each side of the pintle arm.

Install the pintle arm on the hydrostatic pump in the reverse order.

WINDOW (REAR)

Removal

Figure 50-110-1

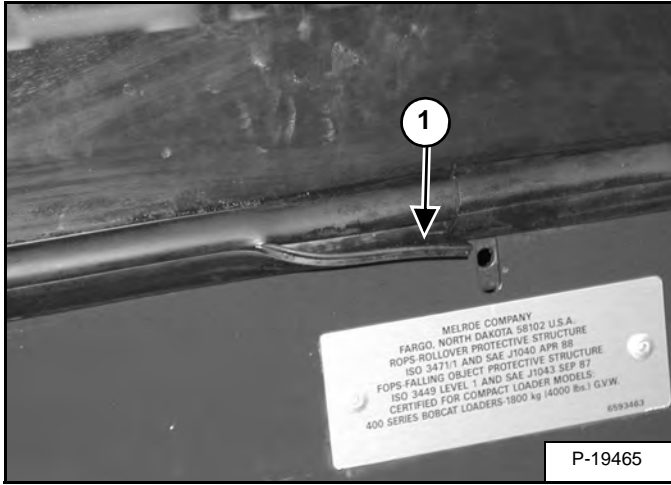

Remove the locking tab (Item 1) [Figure 50-110-1] from the groove in the window molding.

Figure 50-110-2

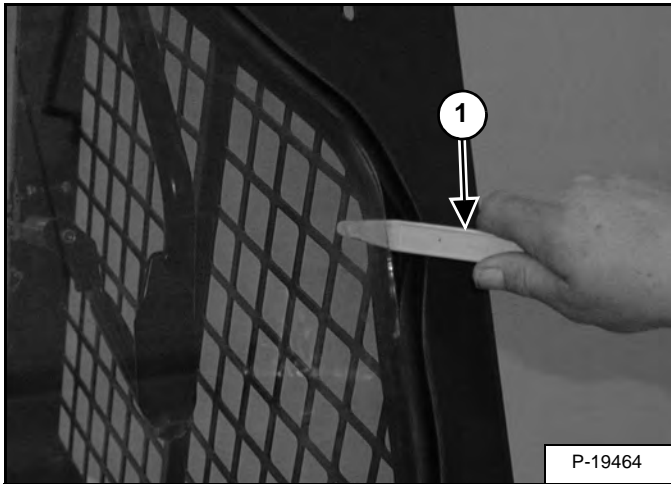

Use a plastic stick (Item 1) [Figure 50-110-2] to pry the window from the molding.

Installation

Figure 50-110-3

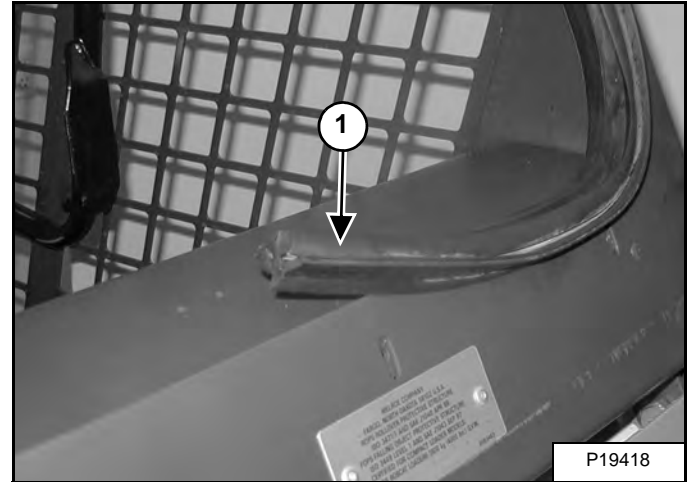

Clean the area before installing the rubber molding.

Install the rubber molding (Item 1) [Figure 50-110-3] around the edge of the rear opening in the operator cab. Cut off the excess molding.

Figure 50-110-4

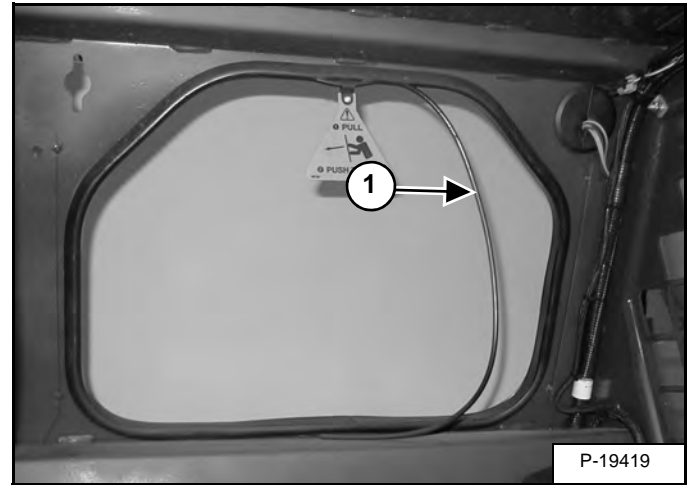

Apply liquid soap on the rubber cord to make installation easier. Install the rubber cord (Item 1) [Figure 50-110-4] into the molding on the inside of the operator cab.

Install the safety tag in the top center of the cord.

WINDOW (REAR) (CONT'D)

Installation (Cont'd)

Figure 50-110-5



Apply liquid soap in the rubber molding to make installation easier. Install the window from the outside of the operator cab [Figure 50-110-5]

Work the window downward until the window is fully seated in the lower portion of the molding [Figure 50-110-5].

Figure 50-110-6

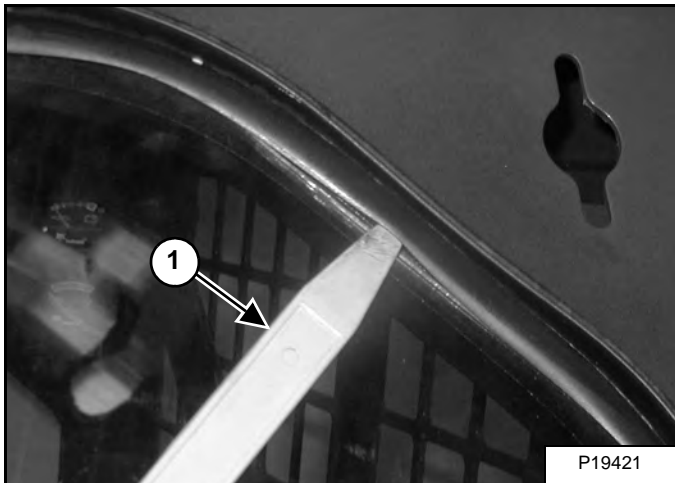

Use a plastic stick (Item 1) [Figure 50-110-6] under the molding lip to guide the window into the molding groove.

Figure 50-110-7

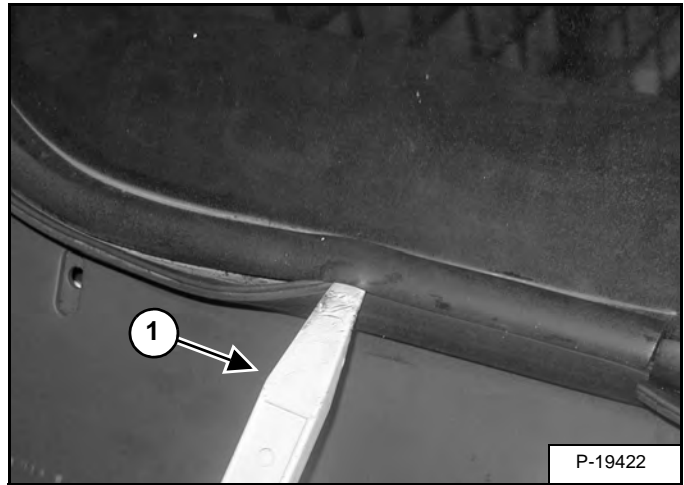

Use a plastic stick (Item 1) [Figure 50-110-7] to position the locking tab into the groove to secure the window in the molding.

Tapping the window corners will help seat the window in the molding.

WINDOW (TOP)

Removal

Figure 50-111-1

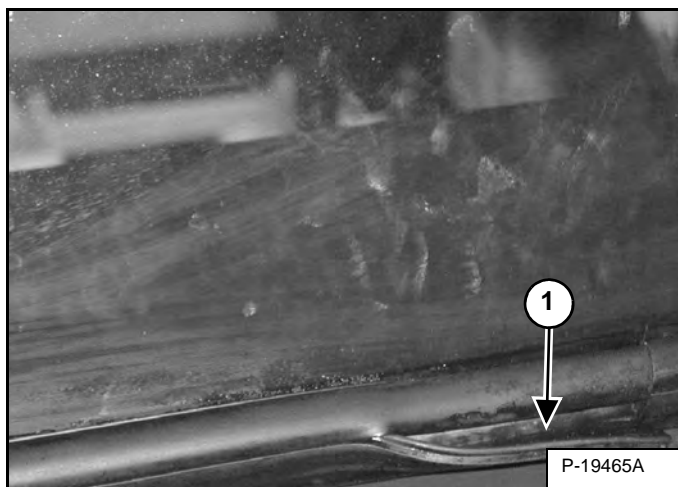

Remove the locking tab (Item 1) [Figure 50-111-1] from the groove in the window molding.

Figure 50-111-2

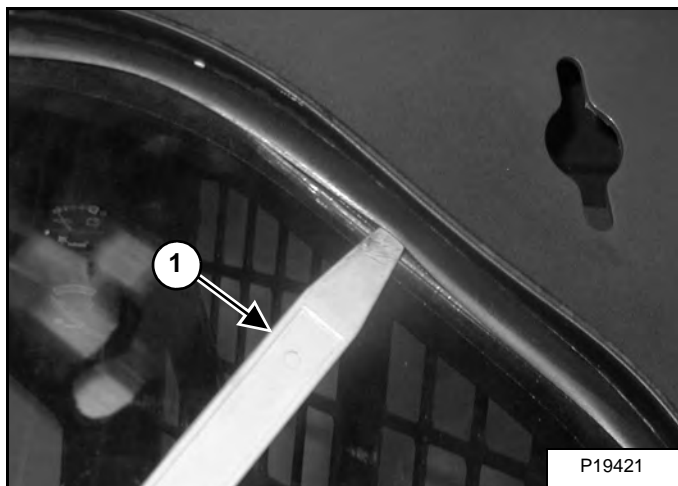

Use a plastic stick (Item 1) [Figure 50-111-2] to pry the window from the molding.

WINDOW (TOP) (CONT'D)

Installation

Clean the area before installing the rubber molding. Liquid soap will help during installation.

Figure 50-111-3

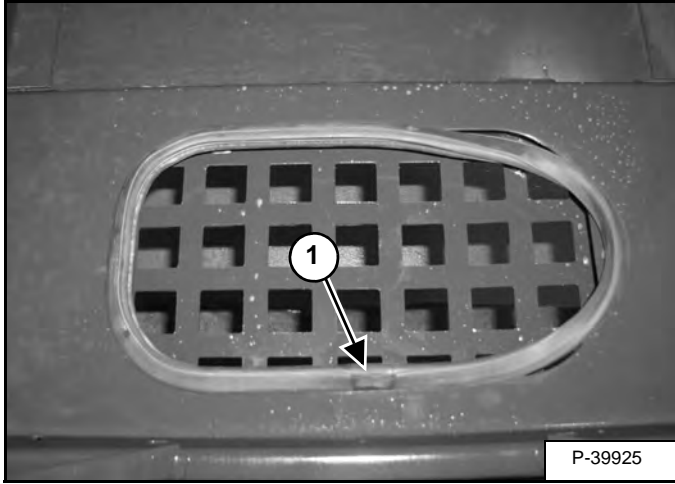

Install the rubber molding in the opening, with the groove (Item 1) [Figure 50-111-3] to the top and at the front edge of the opening.

Figure 50-111-4

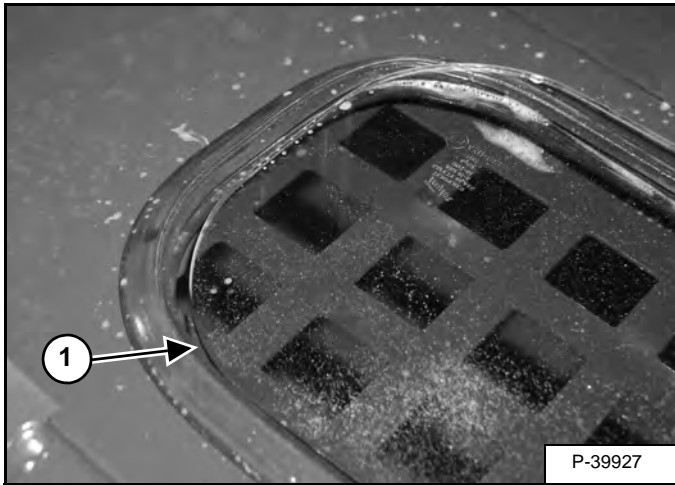

Install one corner of the window in the rubber groove (Item 1) [Figure 50-111-4].

Figure 50-111-5

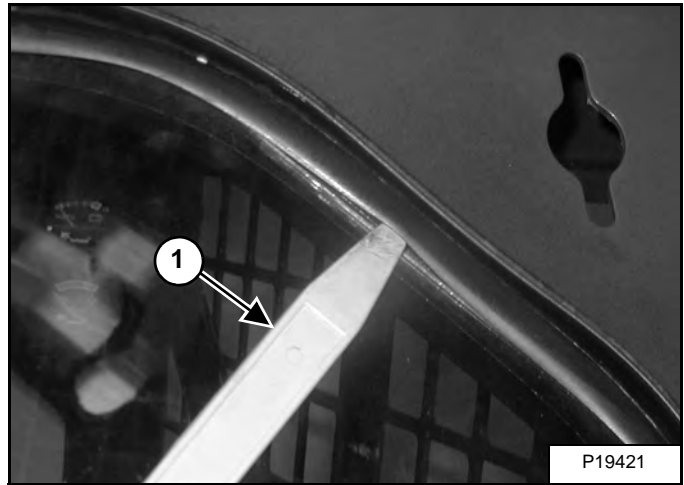

Use a plastic stick (Item 1) [Figure 50-111-5] under the molding lip to guide the window into the molding groove.

Figure 50-111-6

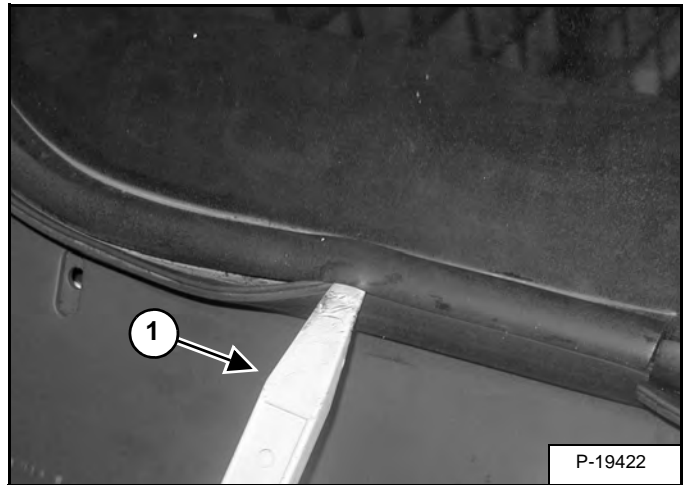

When the window is in the groove, use a plastic stick (Item 1) [Figure 50-111-6] to position the locking tab into the groove to secure the window in the molding.

Tapping the window corners will help seat the window in the molding.

ELECTRICAL SYSTEM AND ANALYSIS

ELECTRICAL SYSTEM INFORMATION	60-10-1
Glossary Of Electrical Symbols	60-10-1
Cab Harness Connectors	60-10-4
Mainframe Harness Connectors	60-10-5
Description	60-10-6
Troubleshooting	60-10-7
Fuse And Relay Location / Identification	60-10-8
Solenoid Testing	60-10-9
BATTERY	60-20-1
Removal And Installation	60-20-1
Battery Maintenance	60-20-2
Maintaining Battery Charge Level	60-20-2
Battery Service During Machine Storage	60-20-2
Battery Testing	60-20-3
Battery Charging	60-20-3
Using A Booster Battery (Jump Starting)	60-20-4
Removing And Installing Battery	60-20-6
ALTERNATOR	60-30-1
Belt Adjustment	60-30-1
Belt Replacement	60-30-1
Charging System Inspection	60-30-2
Alternator Voltage Testing	60-30-3
Low Voltage Testing	60-30-3
High Voltage Testing	60-30-4
Removal And Installation	60-30-5
Parts Identification	60-30-6
STARTER	60-40-1
Testing	60-40-1
Removal And Installation	60-40-3
Parts Identification	60-40-4
INSTRUMENT PANELS	60-50-1
Left And Right Panels	60-50-1
Standard Key Panel	60-50-2
Keyless Start Panel	60-50-2
Option And Field Accessory Panel	60-50-3
Left And Right Removal And Installation	60-50-4
LIGHTS	60-60-1
Front Removal And Installation	60-60-1
Rear Removal And Installation	60-60-2
Cab Light Removal And Installation (Earlier Models)	60-60-3
Cab Light Removal And Installation (Later Models)	60-60-4

BOBCAT INTERLOCK CONTROL SYSTEM (BICS™)	60-70-1
Description	60-70-1
Inspecting The BICS™ Controller (Engine STOPPED - Key ON)	60-70-2
Inspecting The Seat Bar Sensor (Engine RUNNING)	60-70-2
Inspecting The Traction Lock And Parking Brake (Engine RUNNING)	60-70-2
Inspecting The Lift Arm Bypass Control	60-70-2
Inspecting Deactivation Of The Auxiliary Hydraulics System	60-70-3
BOBCAT CONTROLLER (GATEWAY)	60-80-1
Description	60-80-1
Troubleshooting	60-80-1
Viewing Diagnostic Service Codes	60-80-2
Removal And Installation	60-80-3
SEAT BAR SENSOR	60-90-1
Description	60-90-1
Troubleshooting	60-90-1
Testing	60-90-2
Removal And Installation	60-90-3
Bobcat Interlock Control System (BICS™) Circuit Test	60-90-5
TRACTION LOCK	60-100-1
Description	60-100-1
Troubleshooting	60-100-1
Removal And Installation	60-100-2
BACK-UP ALARM SYSTEM (S/N A3W611001 - A3W613689 AND A3W711001 - A3W713379)	60-110-1
Description	60-110-1
Inspecting	60-110-1
Adjusting Switch Position	60-110-2
Troubleshooting	60-110-3
Alarm Removal And Installation	60-110-4
Switch Removal And Installation	60-110-5
BACK-UP ALARM SYSTEM (S/N A3W613690 & ABOVE, A3W713380 & ABOVE, B38V11001 & ABOVE, B38W11001 & ABOVE)	60-111-1
Description	60-111-1
Inspecting	60-111-1
Troubleshooting	60-111-2
Switch Removal And Installation	60-111-3
Alarm Removal And Installation	60-111-4

BACK-UP ALARM SYSTEM (S/N B4TY11001 & ABOVE AND B4UC11001 & ABOVE)	60-112-1
Description	60-112-1
Inspecting	60-112-1
Adjusting Switch Position	60-112-1
Troubleshooting	60-112-2
Alarm Removal And Installation	60-112-3
Switch Removal And Installation	60-112-3



Bobcat®

ELECTRICAL SCHEMATIC

S70 (S/N A3W611001 - A3W611818)

S70 (S/N A3W711001 - A3W712665)

Sheet 1 of 5
PRINTED FEBRUARY 2012

[Printable Version Click Here](#)

GATEWAY CONTROLLER

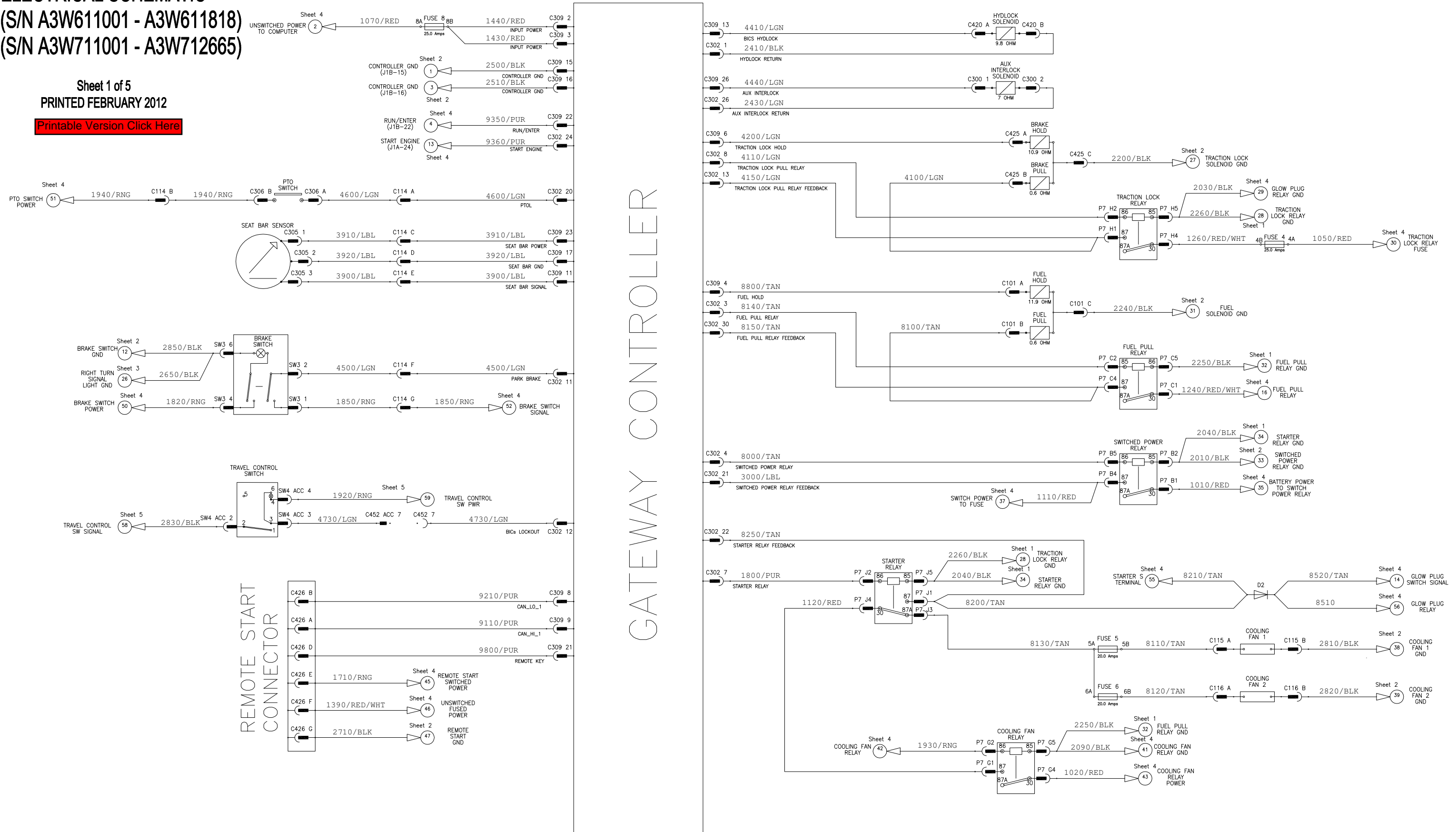

ELECTRICAL SCHEMATIC

S70 (S/N A3W611001 - A3W611818)

S70 (S/N A3W711001 - A3W712665)

Sheet 2 of 5

[Printable Version Click Here](#)

PRINTED FEBRUARY 2012

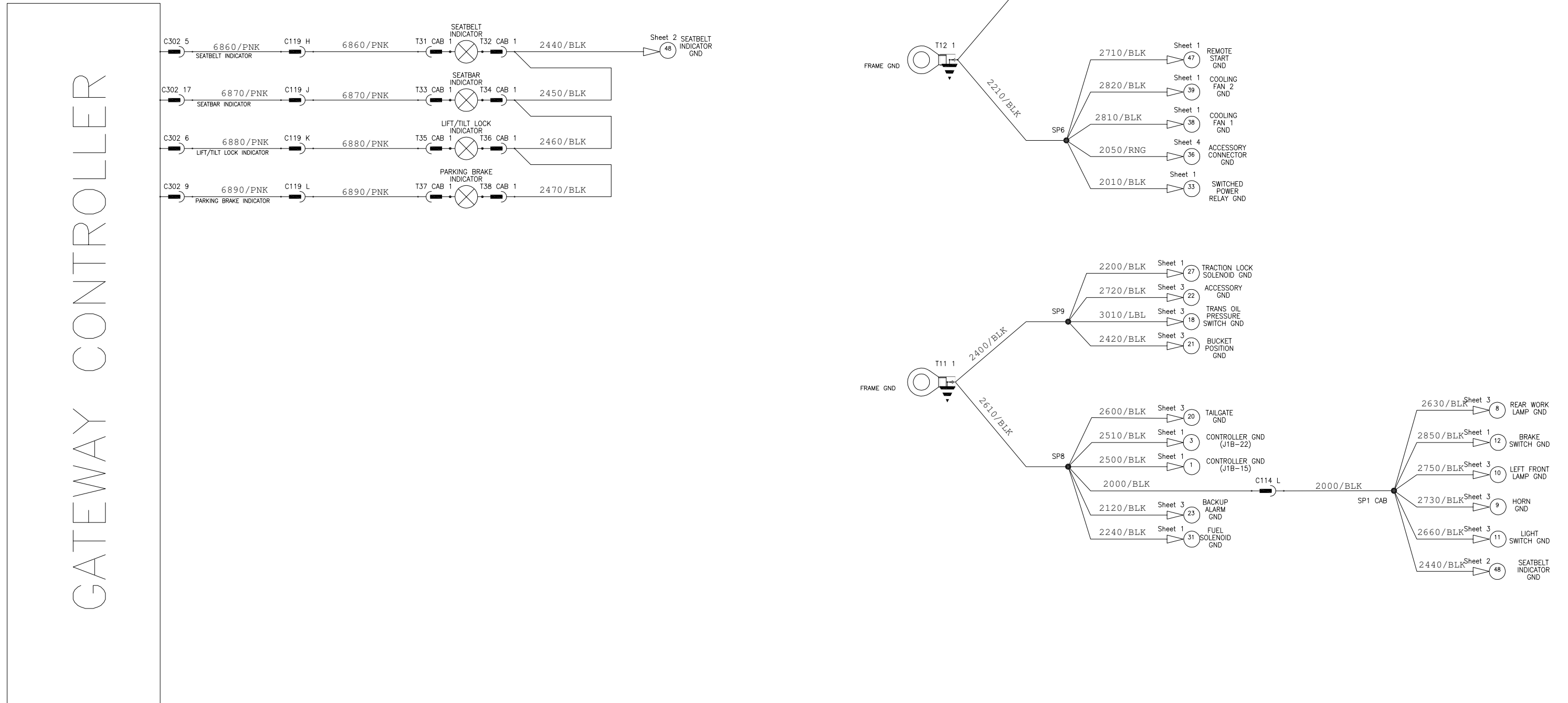

ELECTRICAL SCHEMATIC

S70 (S/N A3W611001 - A3W611818)

S70 (S/N A3W711001 - A3W712665)

Sheet 3 of 5 [Printable Version Click Here](#)
 PRINTED FEBRUARY 2012

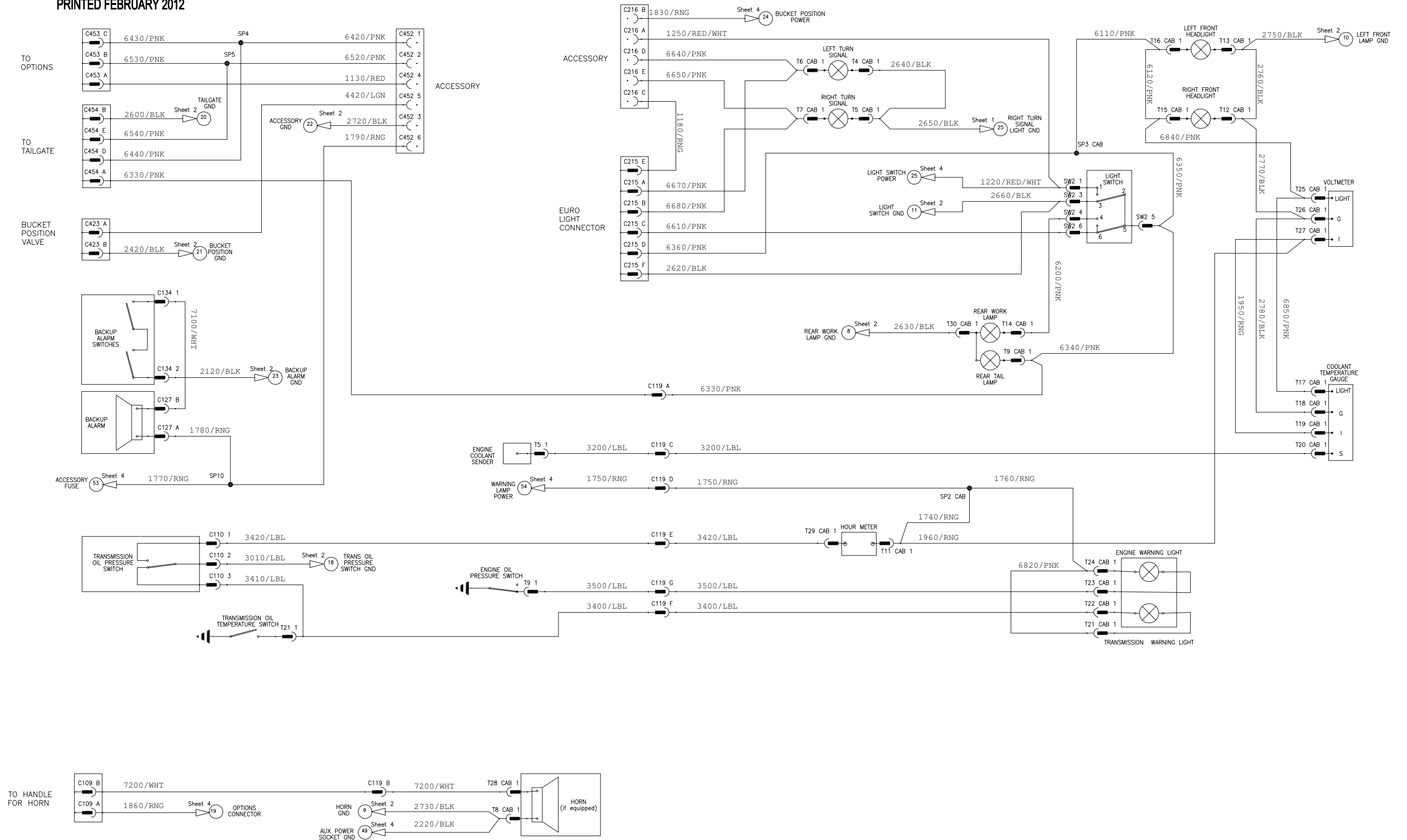

ELECTRICAL SCHEMATIC

S70 (S/N A3W611001 - A3W611818)
 S70 (S/N A3W711001 - A3W712665)

Sheet 4 of 5

[Printable Version Click Here](#)

PRINTED FEBRUARY 2012

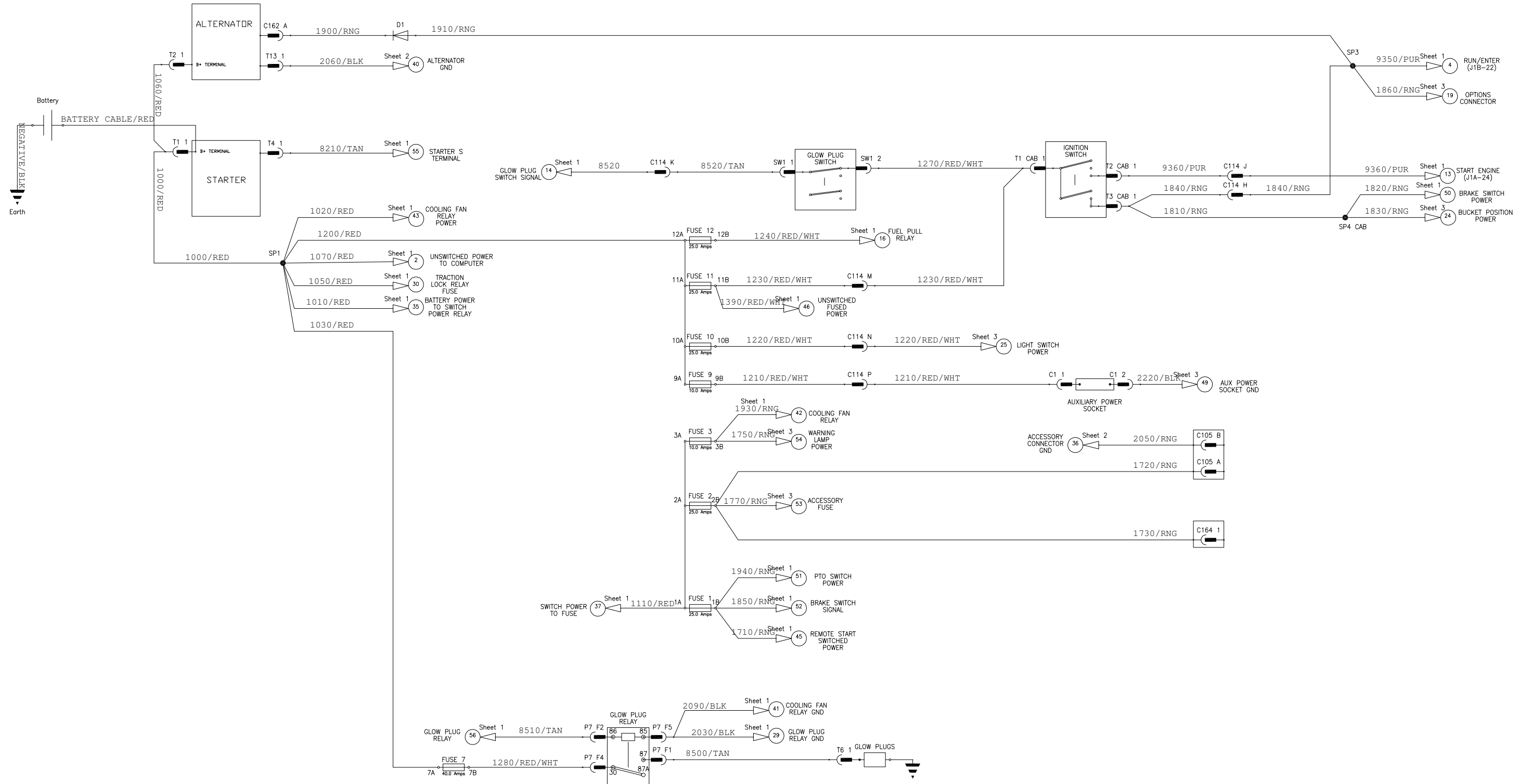

ELECTRICAL SCHEMATIC
S70 (S/N A3W611001 - A3W611818)
S70 (S/N A3W711001 - A3W712665)

[Printable Version Click Here](#)

Sheet 5 of 5
PRINTED FEBRUARY 2012

ACCESSORY HARNESS

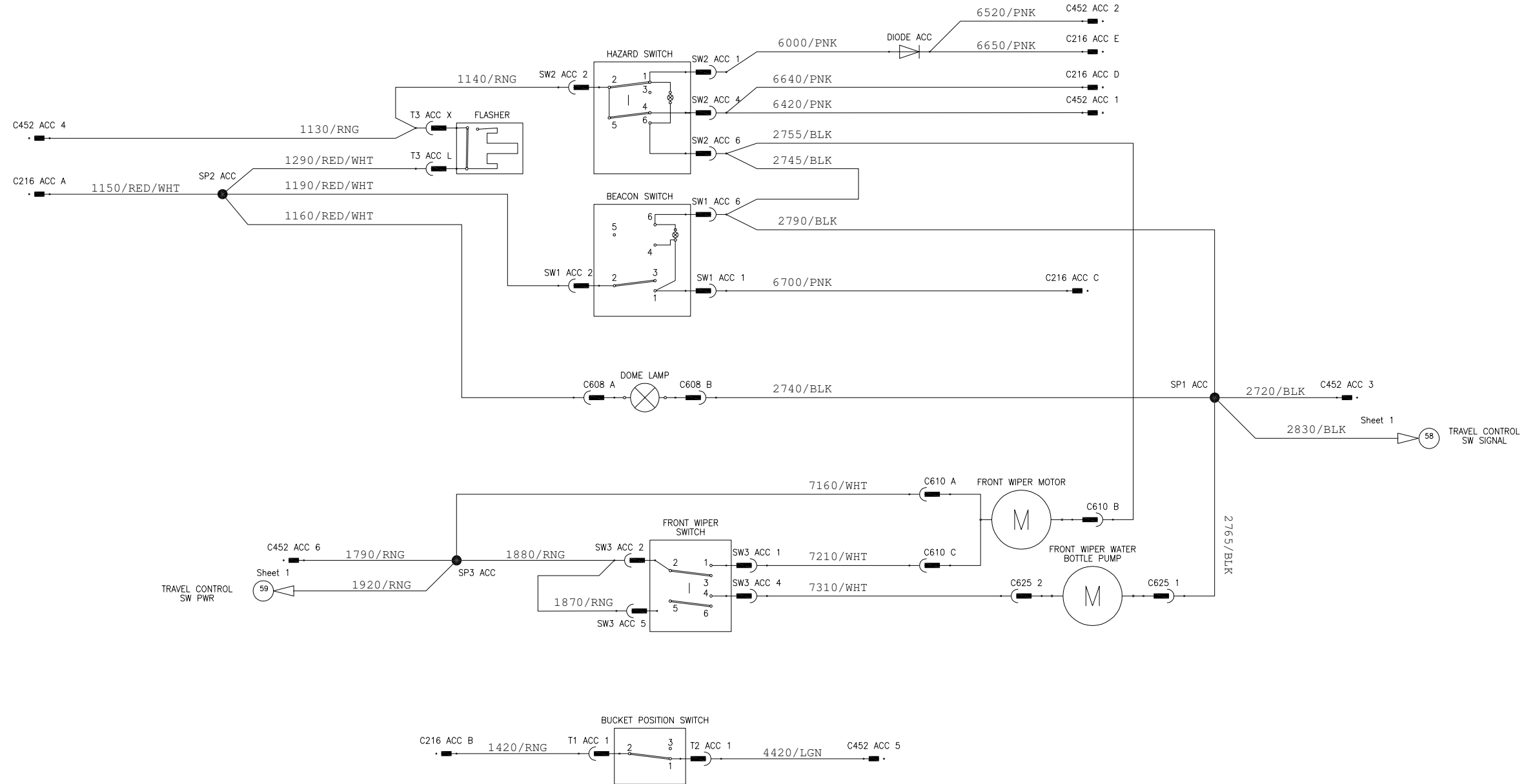

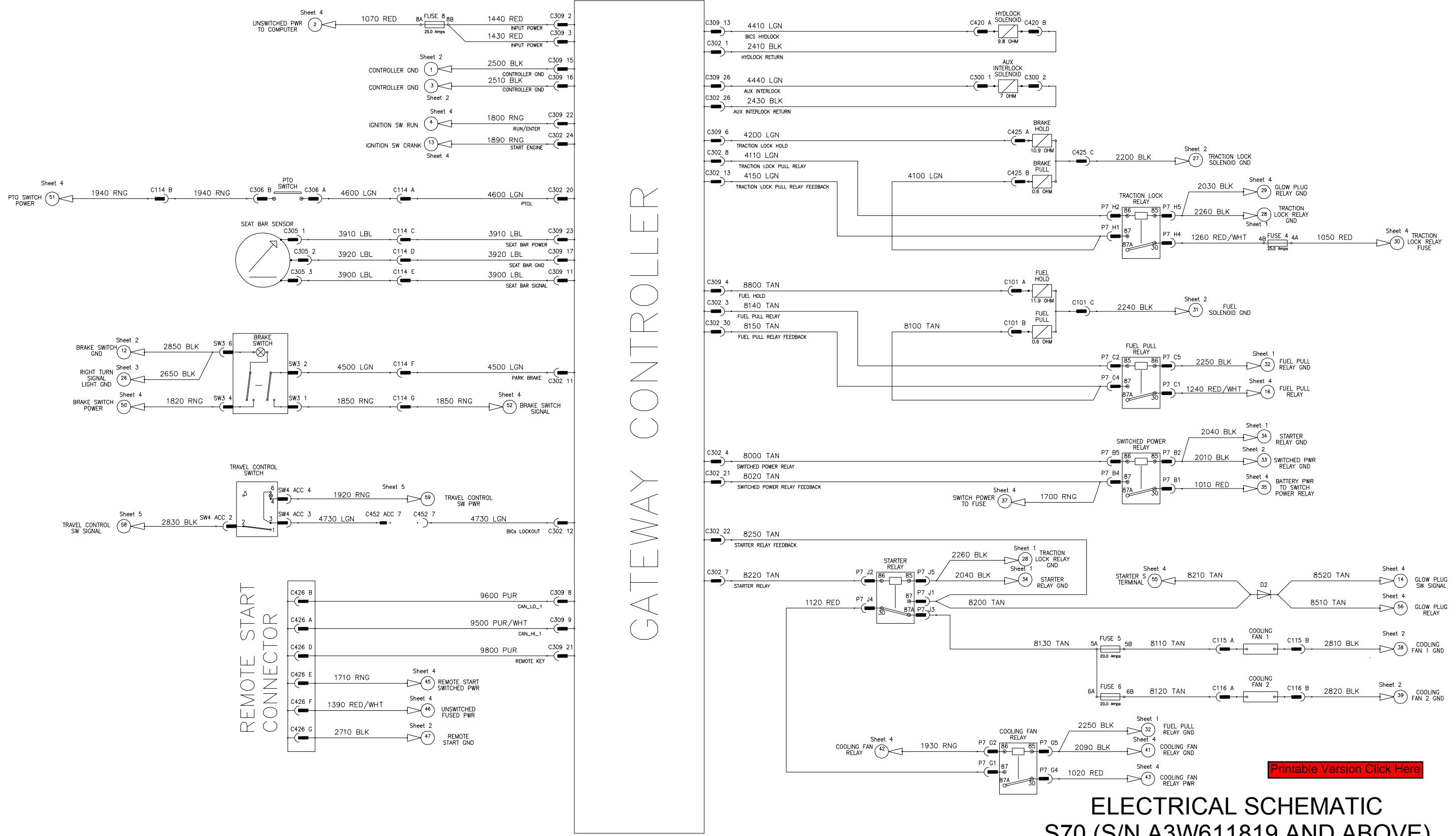

[Printable Version Click Here](#)

**ELECTRICAL SCHEMATIC
S70 (S/N A3W611819 AND ABOVE)
(S/N A3W712666 AND ABOVE)
(S/N B38V11001 - B38V14403)
(S/N B38W11001 - B38W12694)**

GATEWAY CONTROLLER

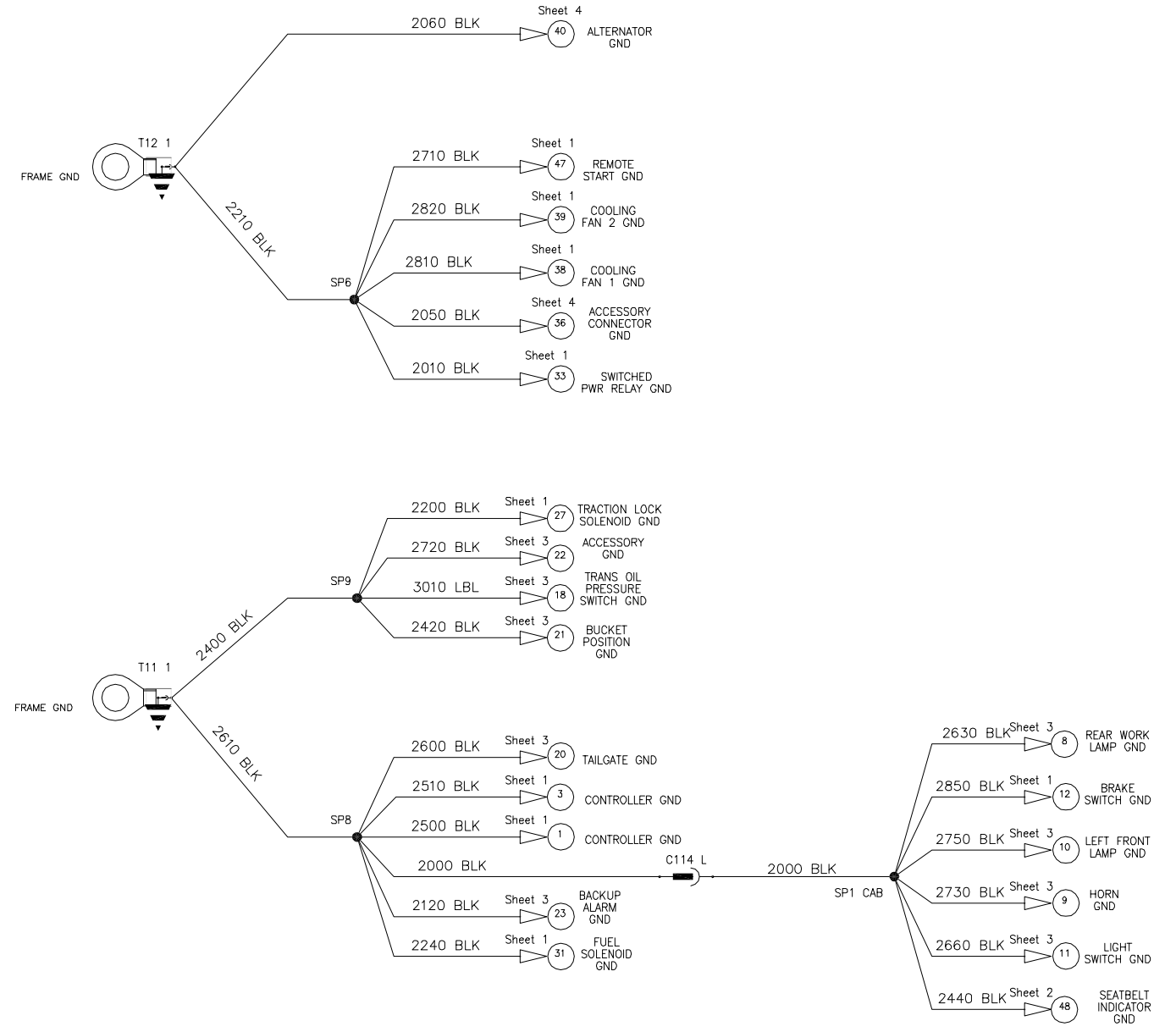
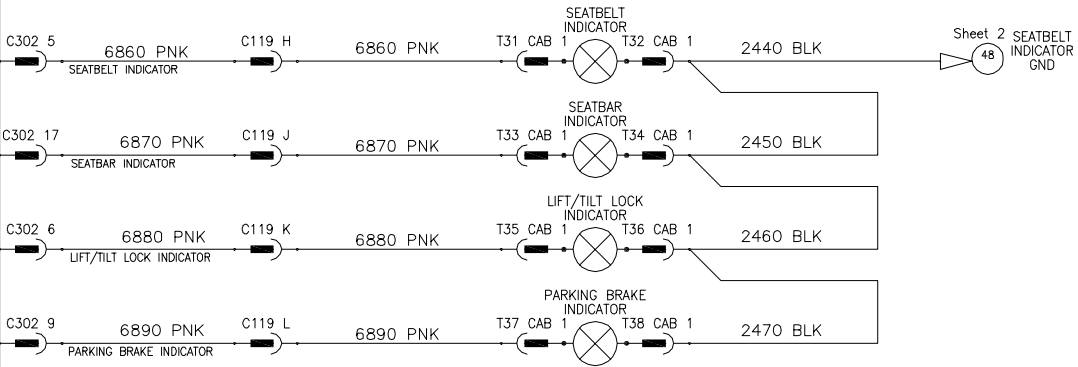

[Printable Version Click Here](#)

ELECTRICAL SCHEMATIC S70 (S/N A3W611819 AND ABOVE) (S/N A3W712666 AND ABOVE) (S/N B38V11001 - B38V14403) (S/N B38W11001 - B38W12694)

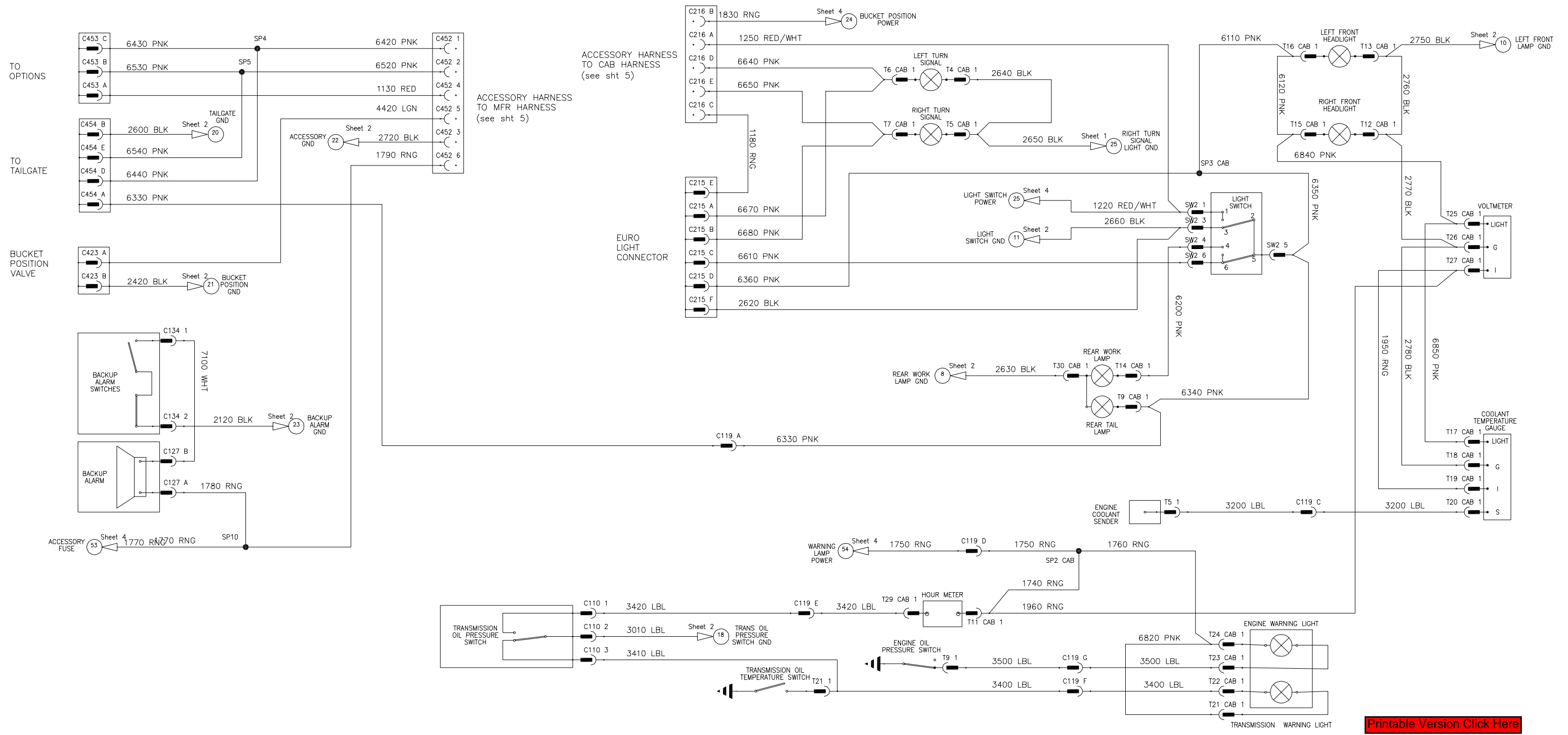

[Printable Version Click Here](#)



**ELECTRICAL SCHEMATIC
S70 (S/N A3W611819 AND ABOVE)
(S/N A3W712666 AND ABOVE)
(S/N B38V11001 - B38V14403)
(S/N B38W11001 - B38W12694)**

Printed in U.S.A.

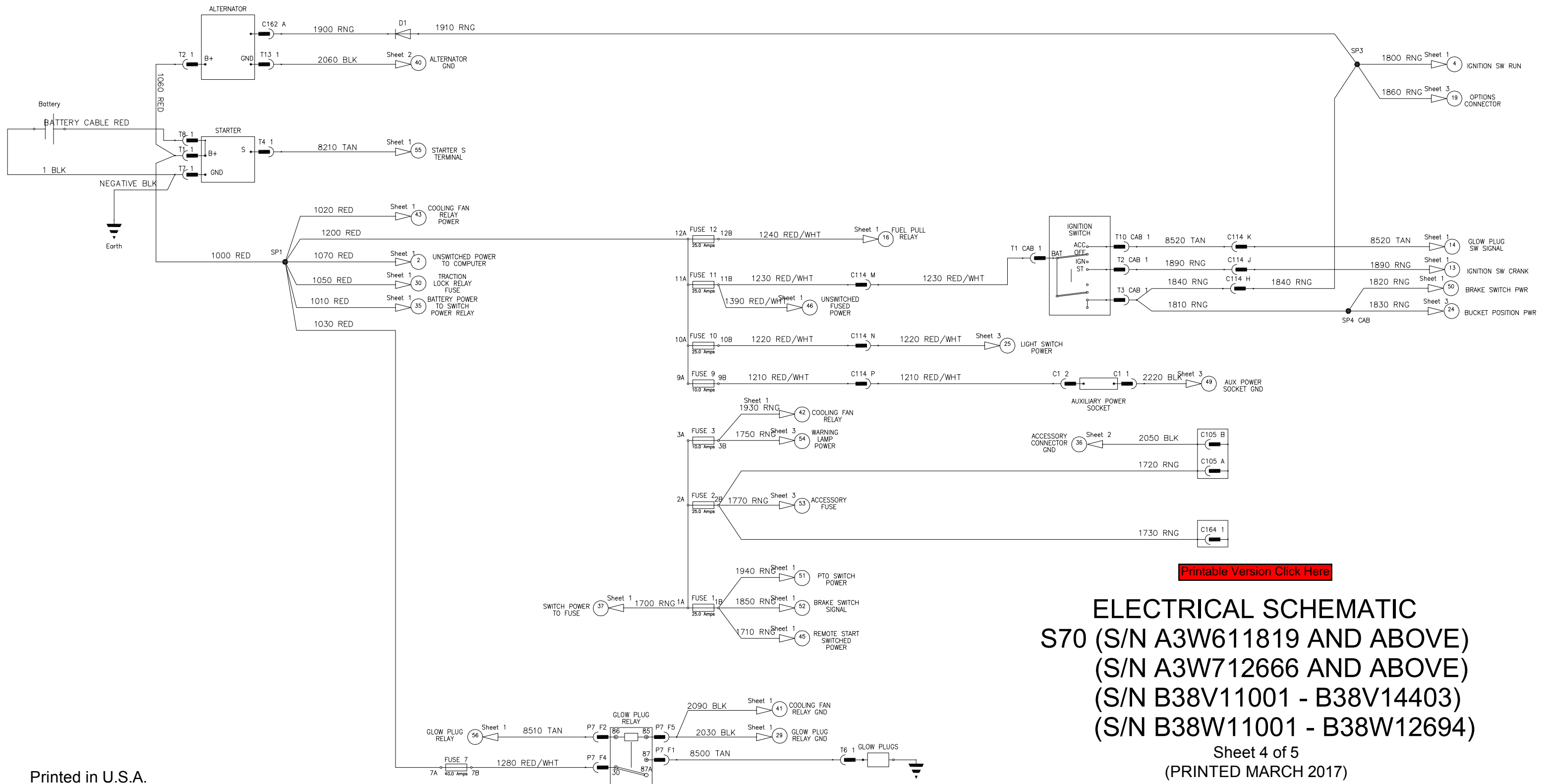

[Printable Version Click Here](#)

**ELECTRICAL SCHEMATIC
S70 (S/N A3W611819 AND ABOVE)
(S/N A3W712666 AND ABOVE)
(S/N B38V11001 - B38V14403)
(S/N B38W11001 - B38W12694)**

Sheet 4 of 5
(PRINTED MARCH 2017)
7169637 (C)

ACCESSORY HARNESS

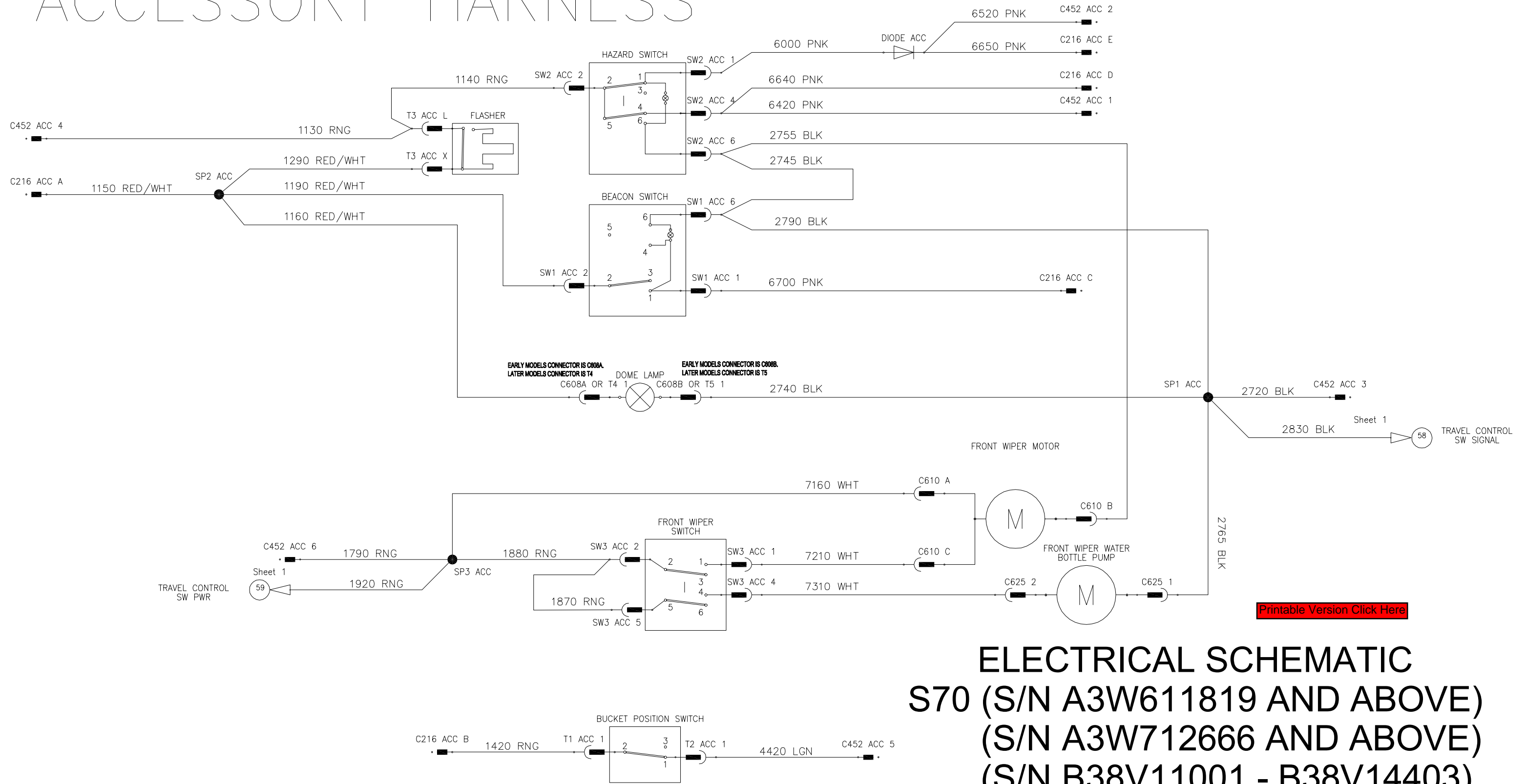

**ELECTRICAL SCHEMATIC
S70 (S/N A3W611819 AND ABOVE)
(S/N A3W712666 AND ABOVE)
(S/N B38V11001 - B38V14403)
(S/N B38W11001 - B38W12694)**

8 7 6 5 4 3 2 1

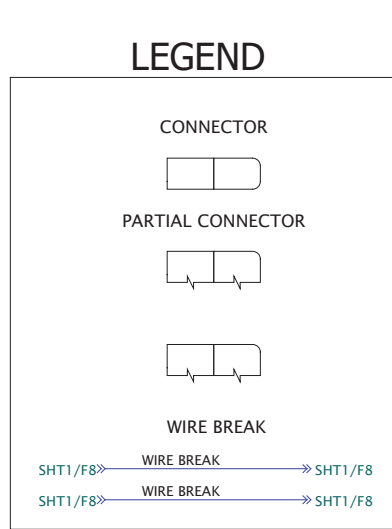

WIRE CATEGORIES FOR COLORS AND NUMBER RANGE

GROUP DESCRIPTION	GROUP NUMBER RANGE	WIRE COLOR	COLOR CODE
BATT FEED, GENERAL	1000 THROUGH 1499	RED	RED
BATT FEED, FUSED	1000 THROUGH 1499	RED/WHITE	RED/WHT
BATT FEED, SWITCHED	1500 THROUGH 1999	ORANGE/WHITE	RNG/WHT
BATTERY GROUND	2000 THROUGH 2999	BLACK	BLK
CONTROLLER GROUND	2000 THROUGH 2999	BROWN	BRN
MONITORING	3000 THROUGH 3999	LIGHT BLUE	LBL
HYDRAULIC	4000 THROUGH 4999	LIGHT GREEN	LGN
CONTROLLER SUPPLY (5V, 8V)	5000 THROUGH 5999	YELLOW	YEL
LIGHTS	6000 THROUGH 6999	PINK	PNK
OTHER FUNCTIONS	7000 THROUGH 7999	WHITE	WHT
ENGINE	8000 THROUGH 8999	TAN	TAN
COMMUNICATION CAN LO	90XX, 92XX, 94XX, 96XX, 98XX	PURPLE	PUR
COMMUNICATION CAN HI	91XX, 93XX, 95XX, 97XX, 99XX	PURPLE/WHITE	PUR/WHT

INDEX TABLE

S. NO	DIAGRAM
1	SH01 - INDEX
2	SH02 - MAINFRAME
3	SH03 - GROUND
4	SH04 - GAUGES/LIGHTS
5	SH05 - POWER
6	SH06 - ACCESSORY
7	SH07 - OPTIONS 1
8	SH08 - OPTIONS 2

HARNESS PART NUMBER

MAINFRAME	7306655
CAB	7148518
ACCESSORIES	7154343
RENTAL	7167049
ZTR	7271334
BACKUP ALARM	7172891

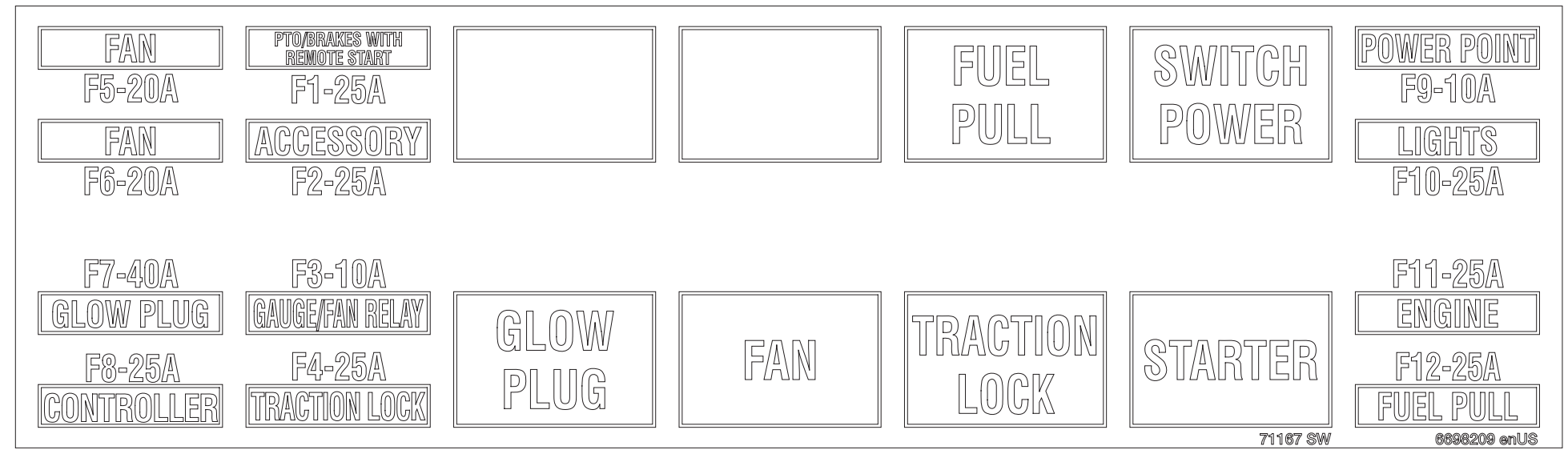

**Wiring Schematic
Standard Machine**

S70 S/N B38V14404 through B38V15916
S/N B38W12695 through B38W13305

Printed On October 2019

[Printable Version Click Here](#)

**7308526_0
Sheet 1 of 8**

[Click Here for Interactive PDF](#)

8 7 6 5 4 3 2 1

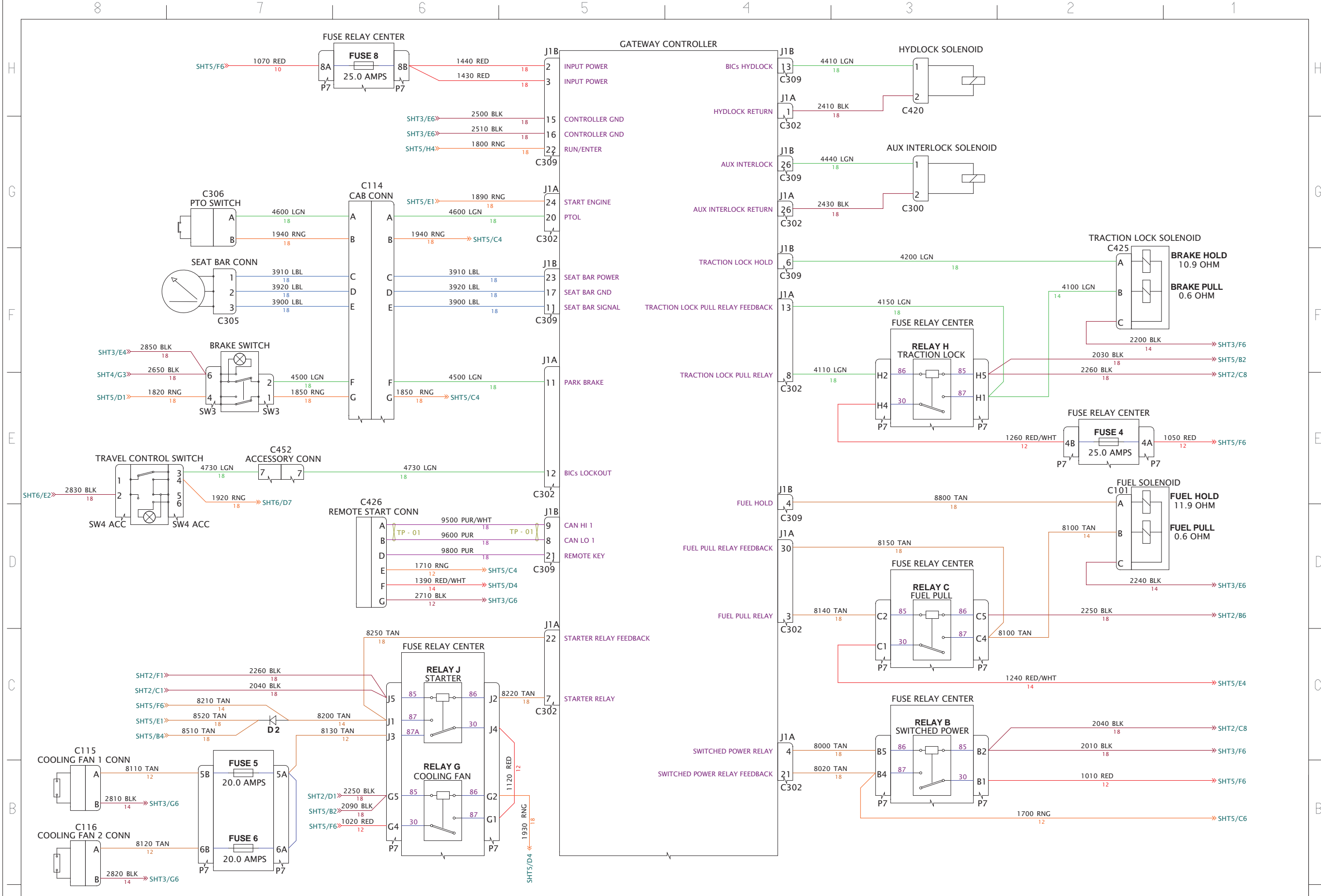

Wiring Schematic
Standard Machine

S70

S/N B38V14404 through B38V15916

S/N B38W12695 through B38W13305

Printed On October 2019

[Printable Version Click Here](#)

7308526_0

Sheet 2 of 8

GROUND

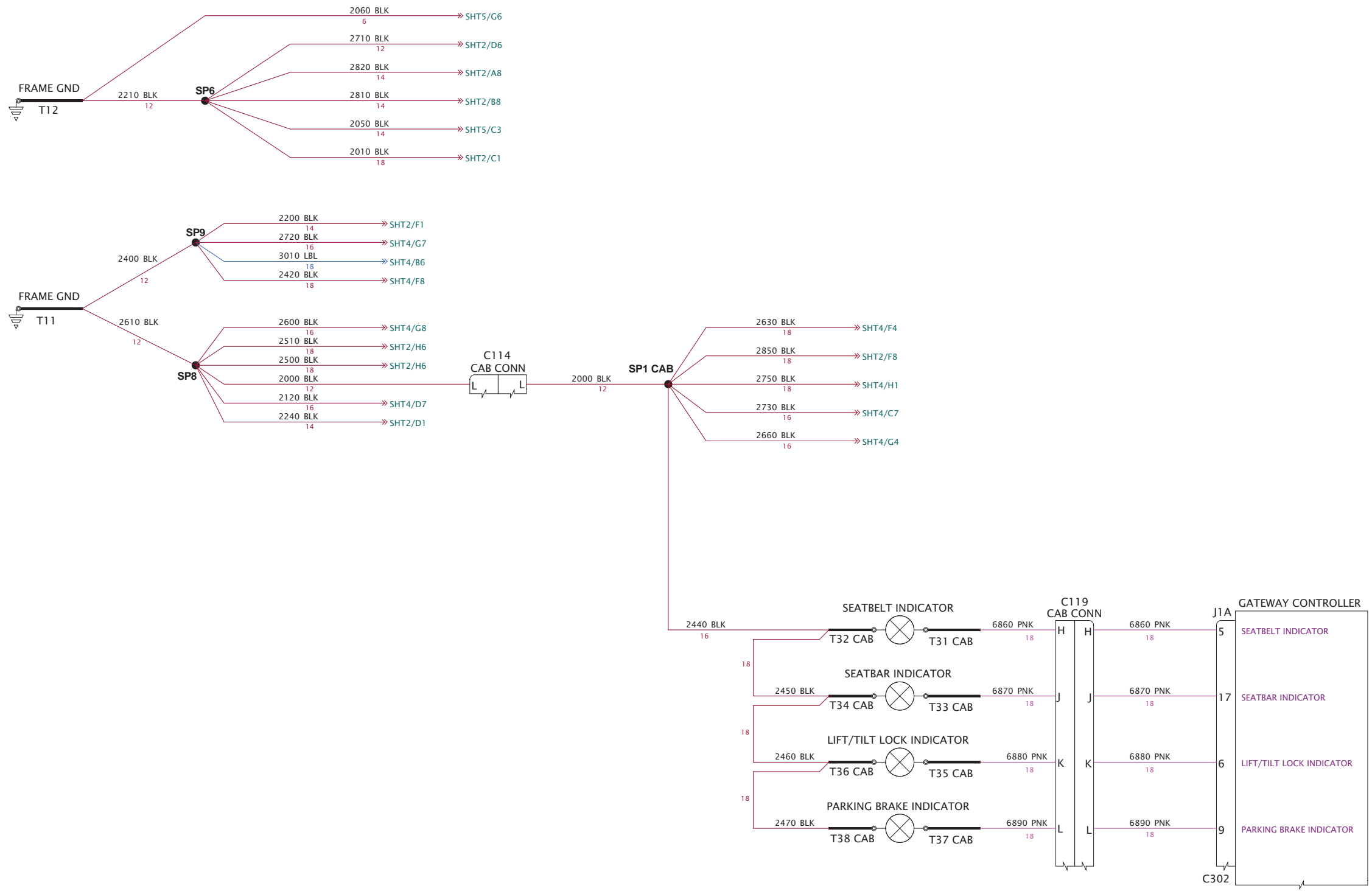

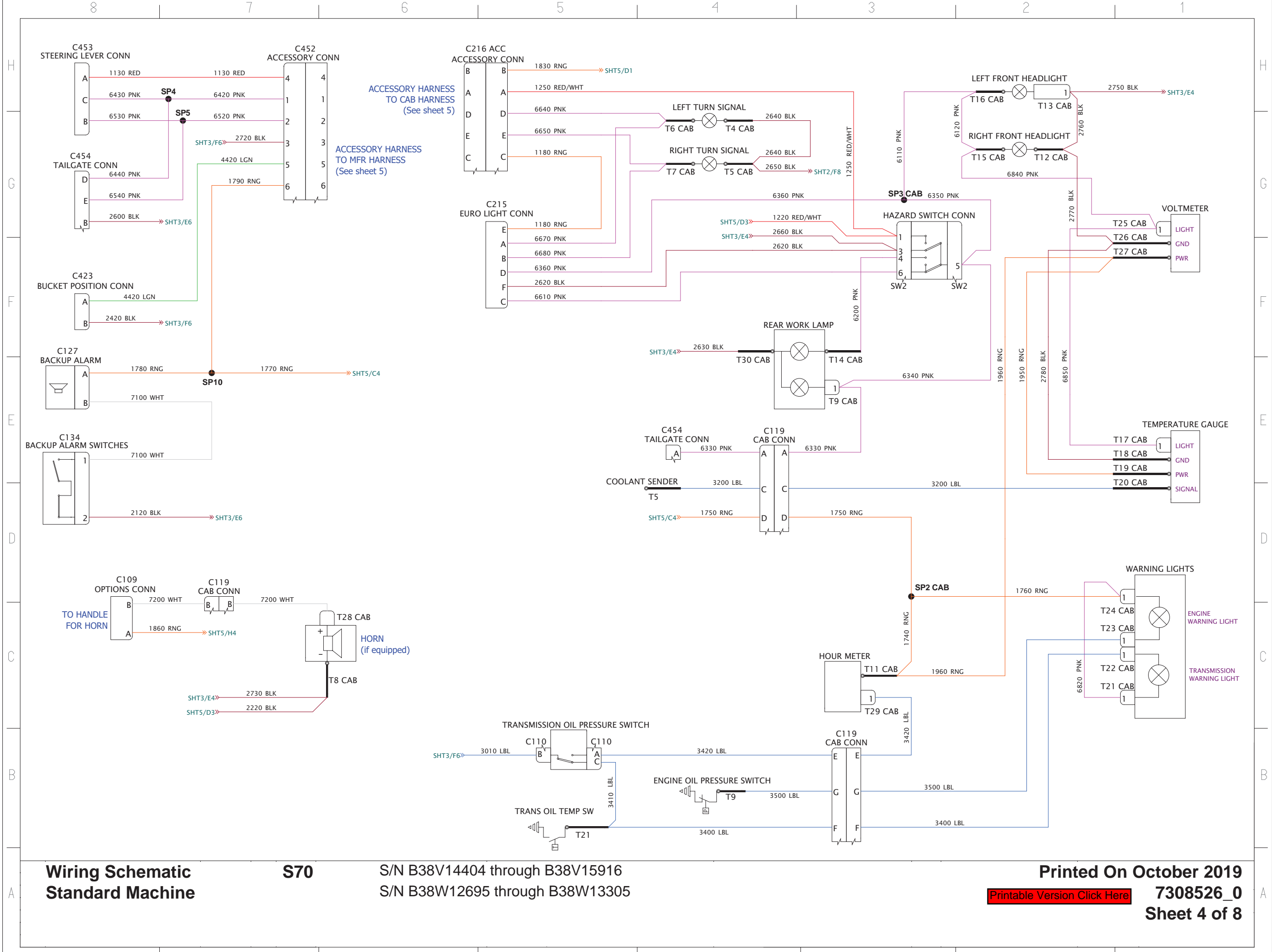

**Wiring Schematic
Standard Machine**

S70

S/N B38V14404 through B38V15916
S/N B38W12695 through B38W13305

Printed On October 2019

[Printable Version Click Here](#)

7308526_0

Sheet 4 of 8

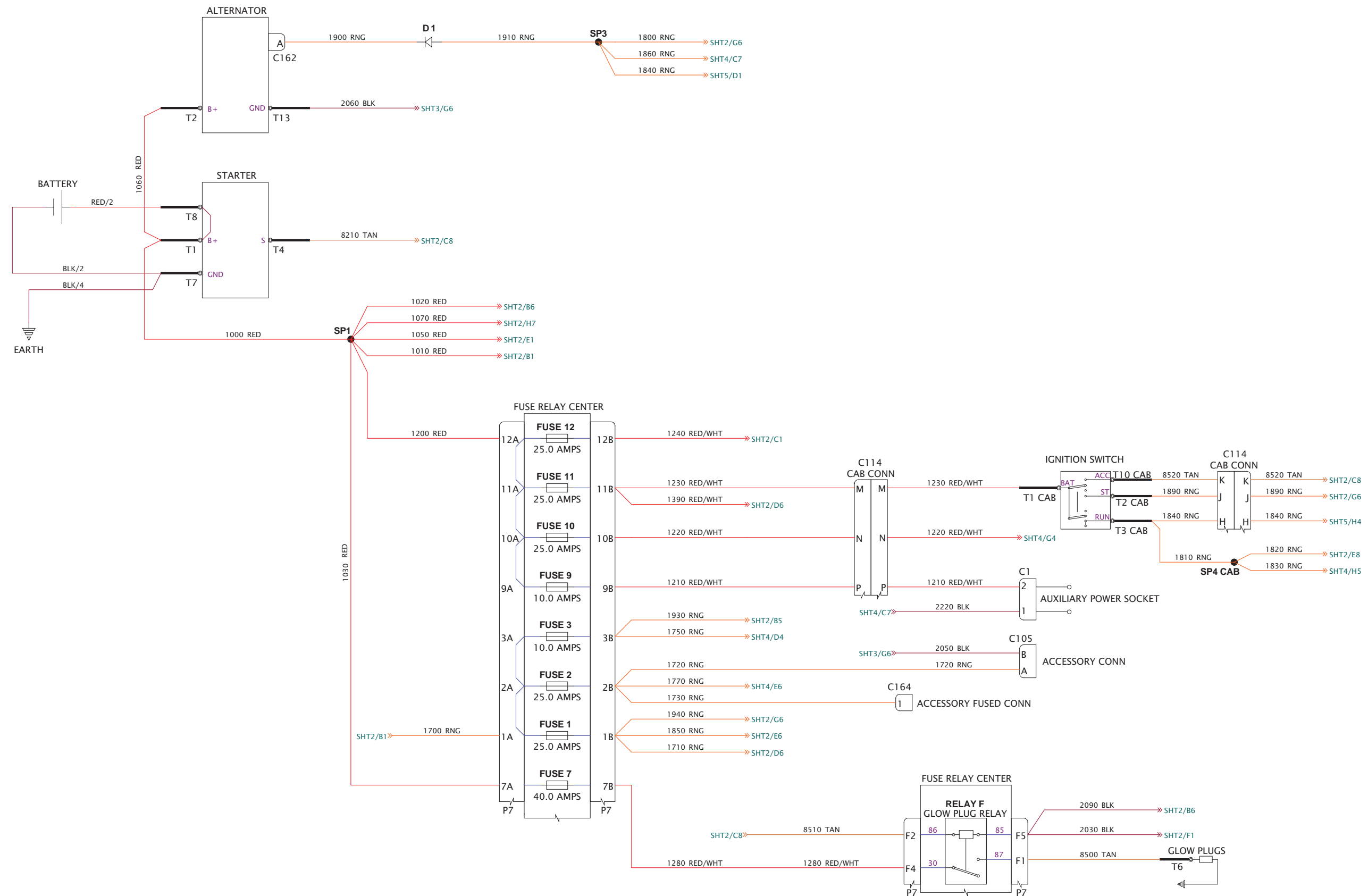

ACCESSORY HARNESS

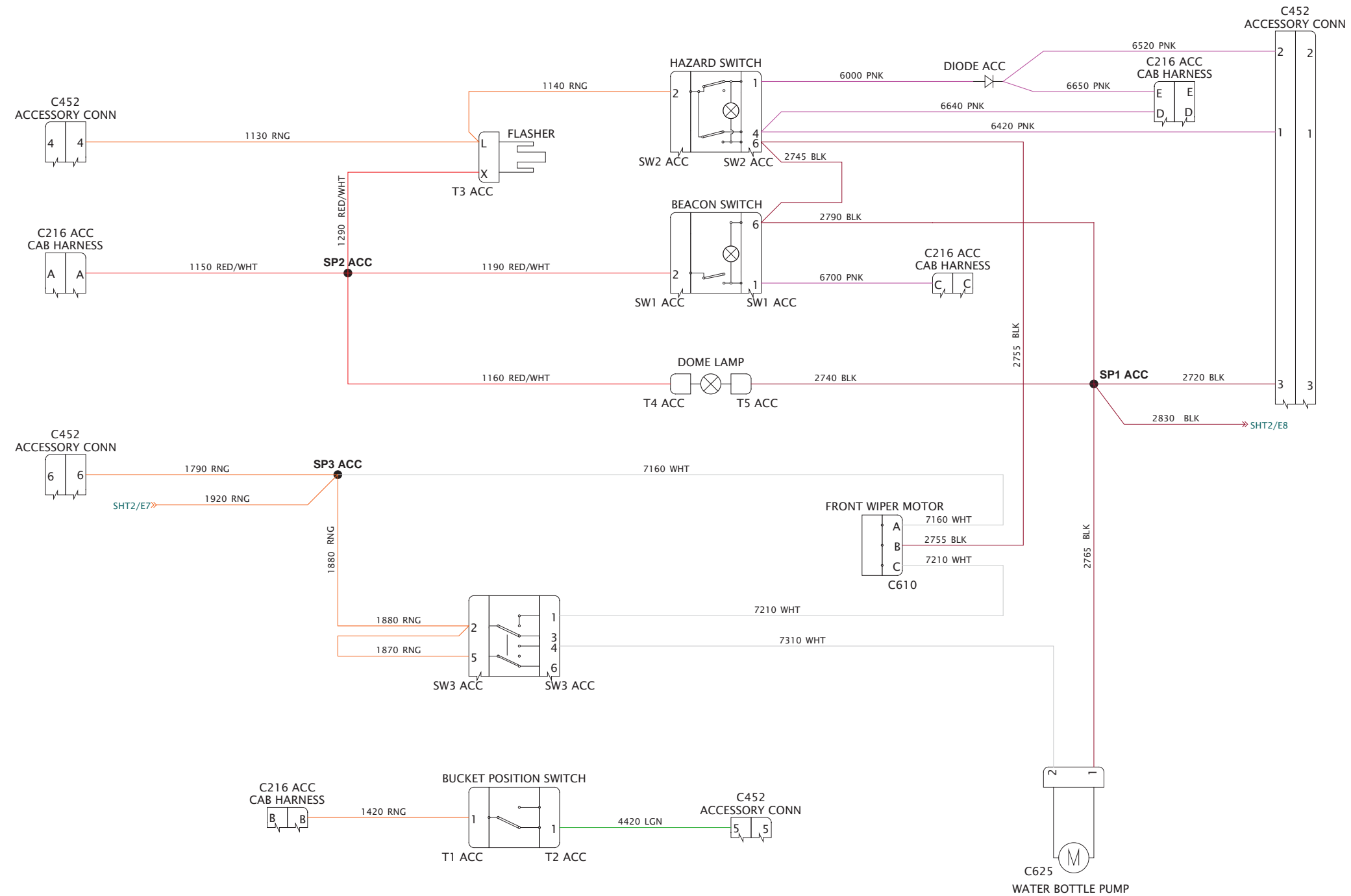

HARNESS RENTAL, PN 7167049

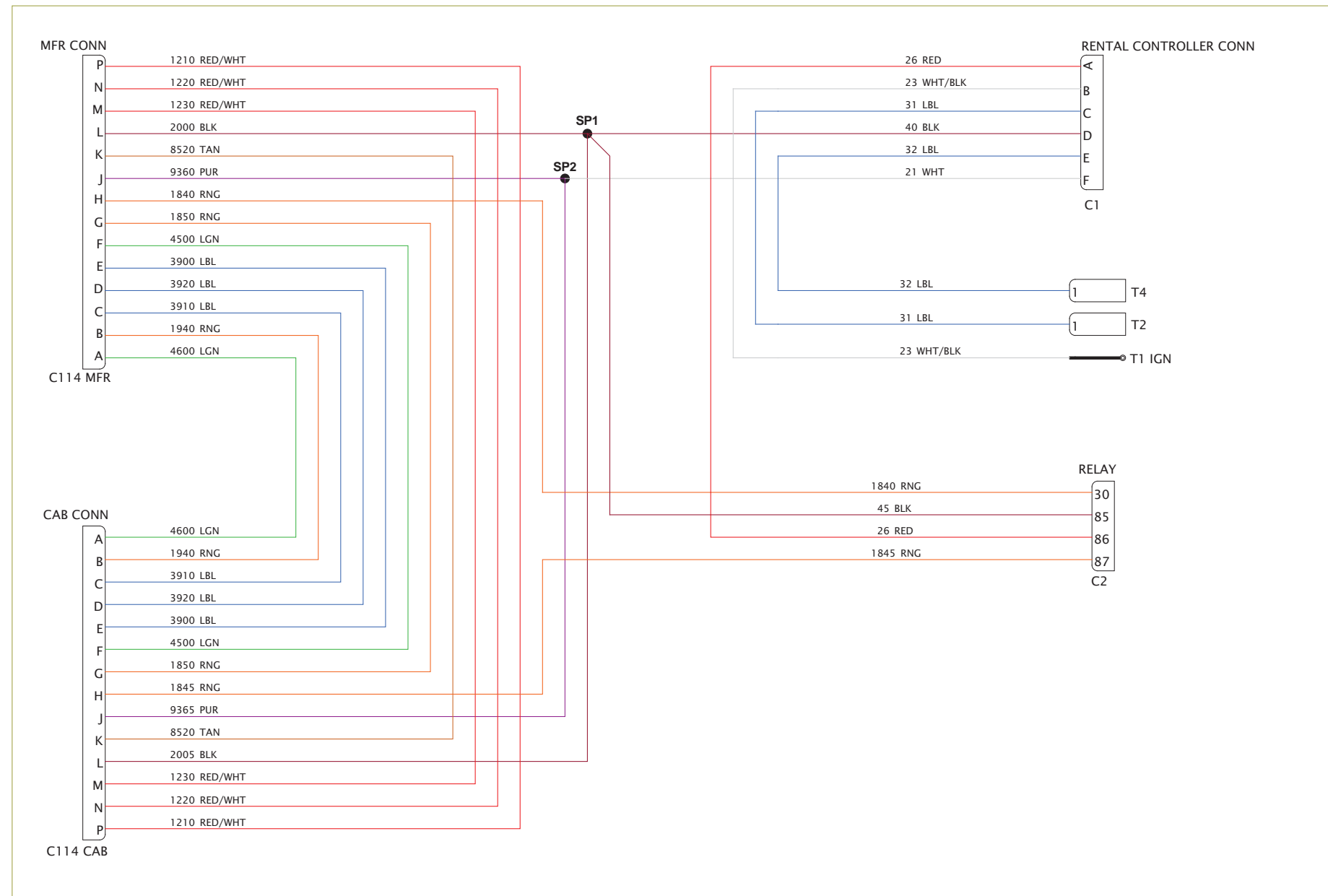

HARNESS BACKUP ALARM, PN 7172891

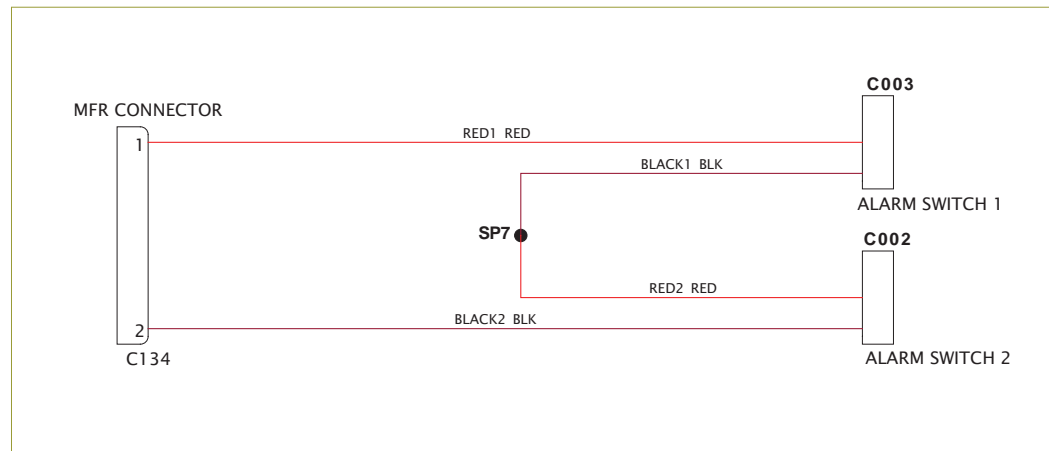

HARNESS ZTR, PN 7271334

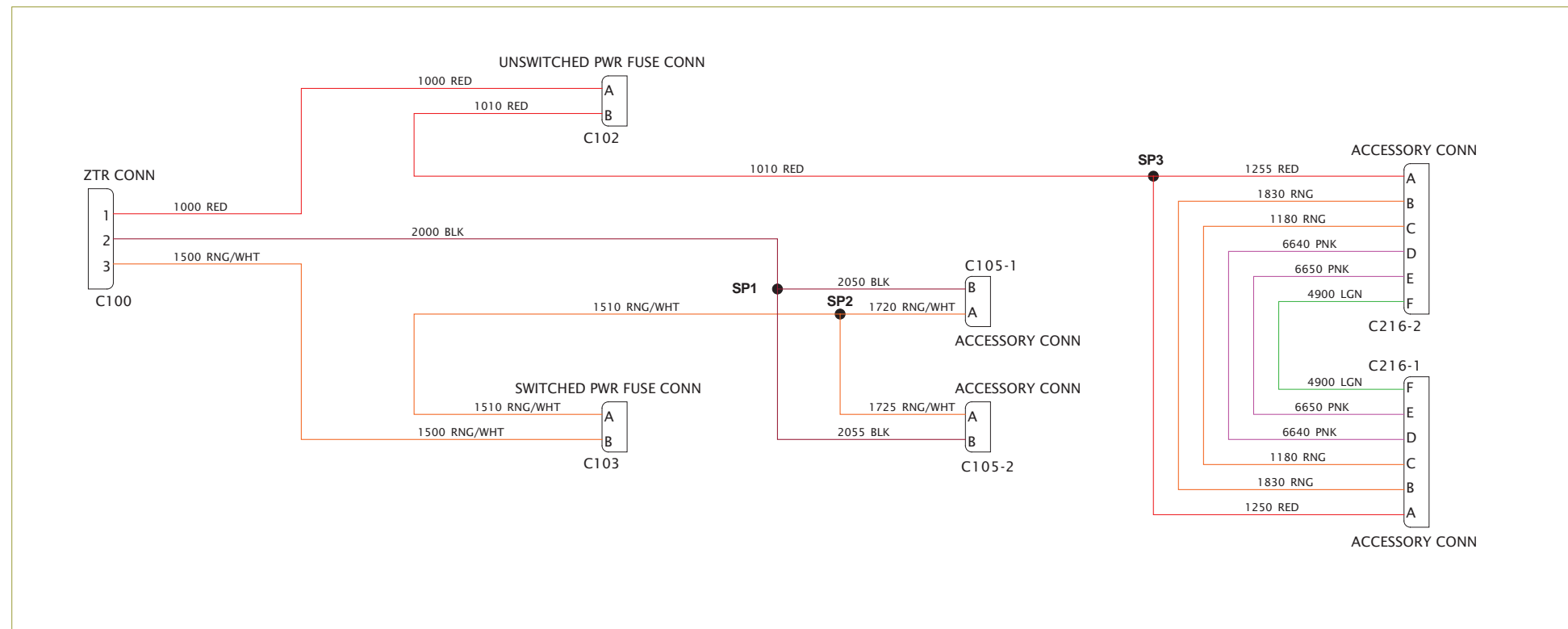

8 7 6 5 4 3 2 1

LEGEND

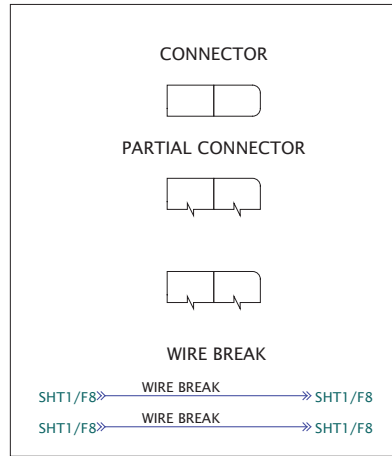

WIRE CATEGORIES FOR COLORS AND NUMBER RANGE			
GROUP DESCRIPTION	GROUP NUMBER RANGE	WIRE COLOR	COLOR CODE
BATT FEED, GENERAL	1000 THROUGH 1499	RED	RED
BATT FEED, FUSED	1000 THROUGH 1499	RED/WHITE	RED/WHT
BATT FEED, SWITCHED	1500 THROUGH 1999	ORANGE/WHITE	RNG/WHT
BATTERY GROUND	2000 THROUGH 2999	BLACK	BLK
CONTROLLER GROUND	2000 THROUGH 2999	BROWN	BRN
MONITORING	3000 THROUGH 3999	LIGHT BLUE	LBL
HYDRAULIC	4000 THROUGH 4999	LIGHT GREEN	LGN
CONTROLLER SUPPLY (5V, 8V)	5000 THROUGH 5999	YELLOW	YEL
LIGHTS	6000 THROUGH 6999	PINK	PNK
OTHER FUNCTIONS	7000 THROUGH 7999	WHITE	WHT
ENGINE	8000 THROUGH 8999	TAN	TAN
COMMUNICATION CAN LO	90XX, 92XX, 94XX, 96XX, 98XX	PURPLE	PUR
COMMUNICATION CAN HI	91XX, 93XX, 95XX, 97XX, 99XX	PURPLE/WHITE	PUR/WHT

INDEX TABLE	
S. NO	DIAGRAM
1	SH01 - INDEX
2	SH02 - MAINFRAME
3	SH03 - GROUND
4	SH04 - GAUGES/LIGHTS
5	SH05 - POWER
6	SH06 - ACCESSORY
7	SH07 - OPTIONS 1
8	SH08 - OPTIONS 2

HARNESS PART NUMBER	
MAINFRAME	7306655
CAB	7336049
ACCESSORIES	7154343
RENTAL	7167049
ZTR	7271334
BACKUP ALARM	7172891

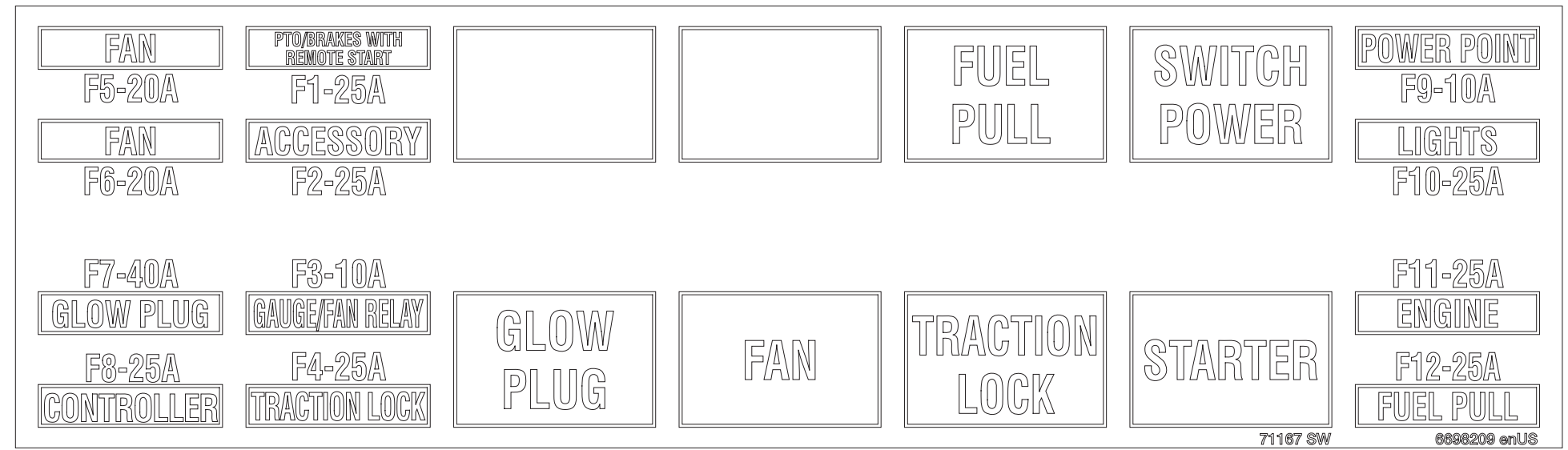

**Wiring Schematic
Standard Machine**

S70

S/N B38V15917 & Above
S/N B38W13306 & Above
S/N B4TY11001 & Above
S/N B4UC11001 & Above

Printed On October 2019

[Printable Version Click Here](#)

**7336048 (A)
Sheet 1 of 8**

[Click Here for Interactive PDF](#)

8 7 6 5 4 3 2 1

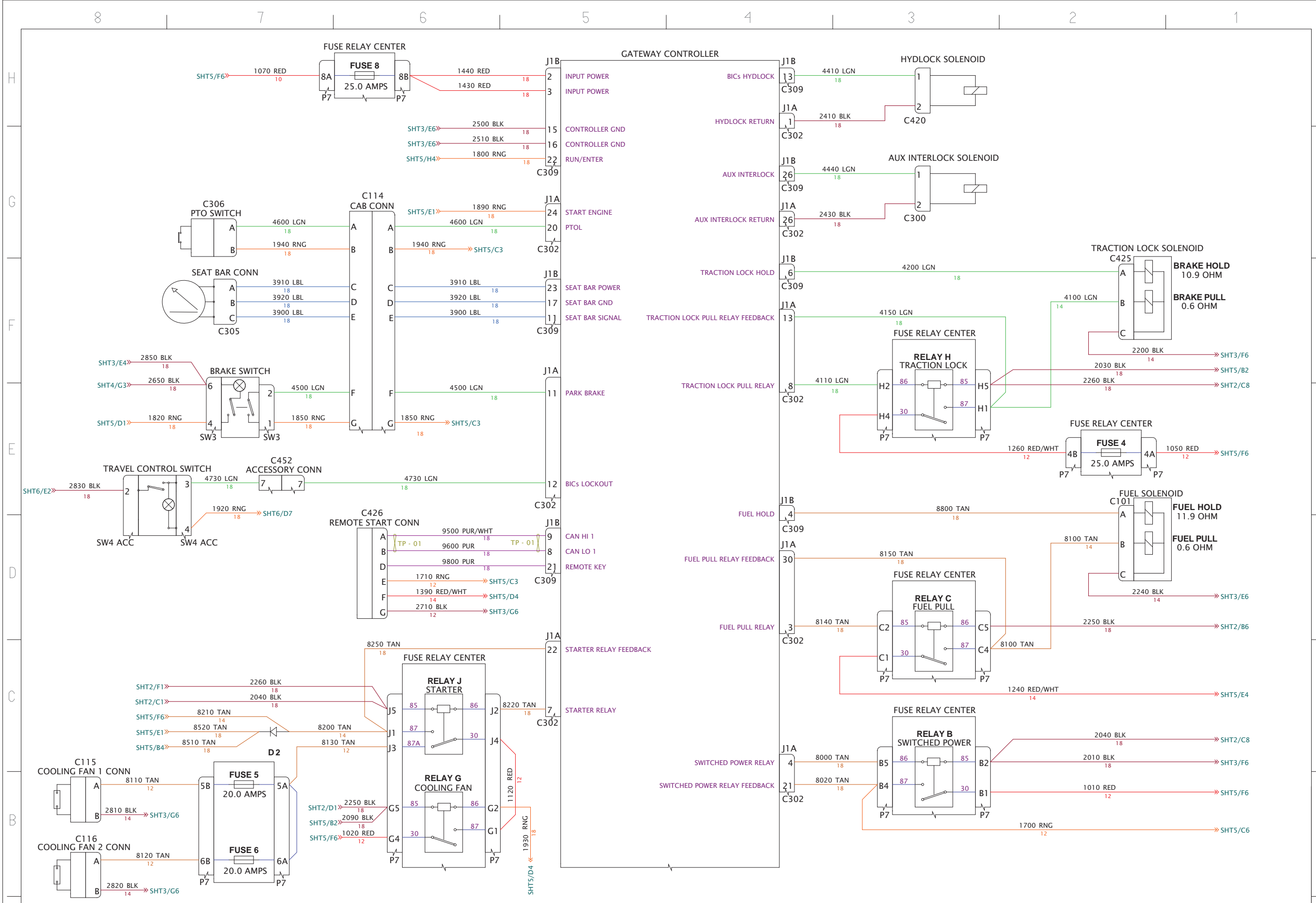

Wiring Schematic
Standard Machine

S70

S/N B38V15917 & Above
 S/N B38W13306 & Above
 S/N B4TY11001 & Above
 S/N B4UC11001 & Above

Printed On October 2019

[Printable Version Click Here](#)

7336048 (A)
Sheet 2 of 8

GROUND

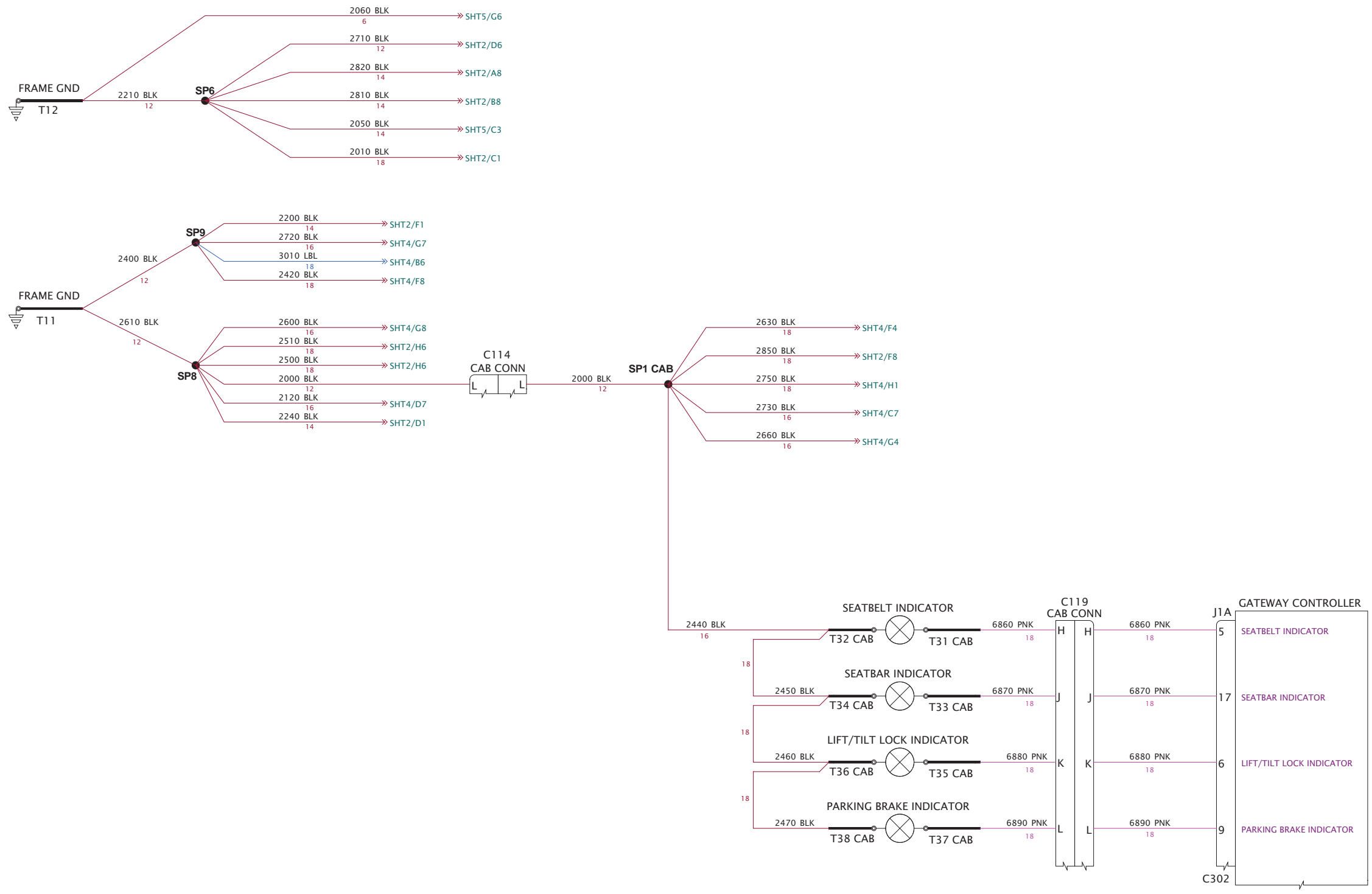

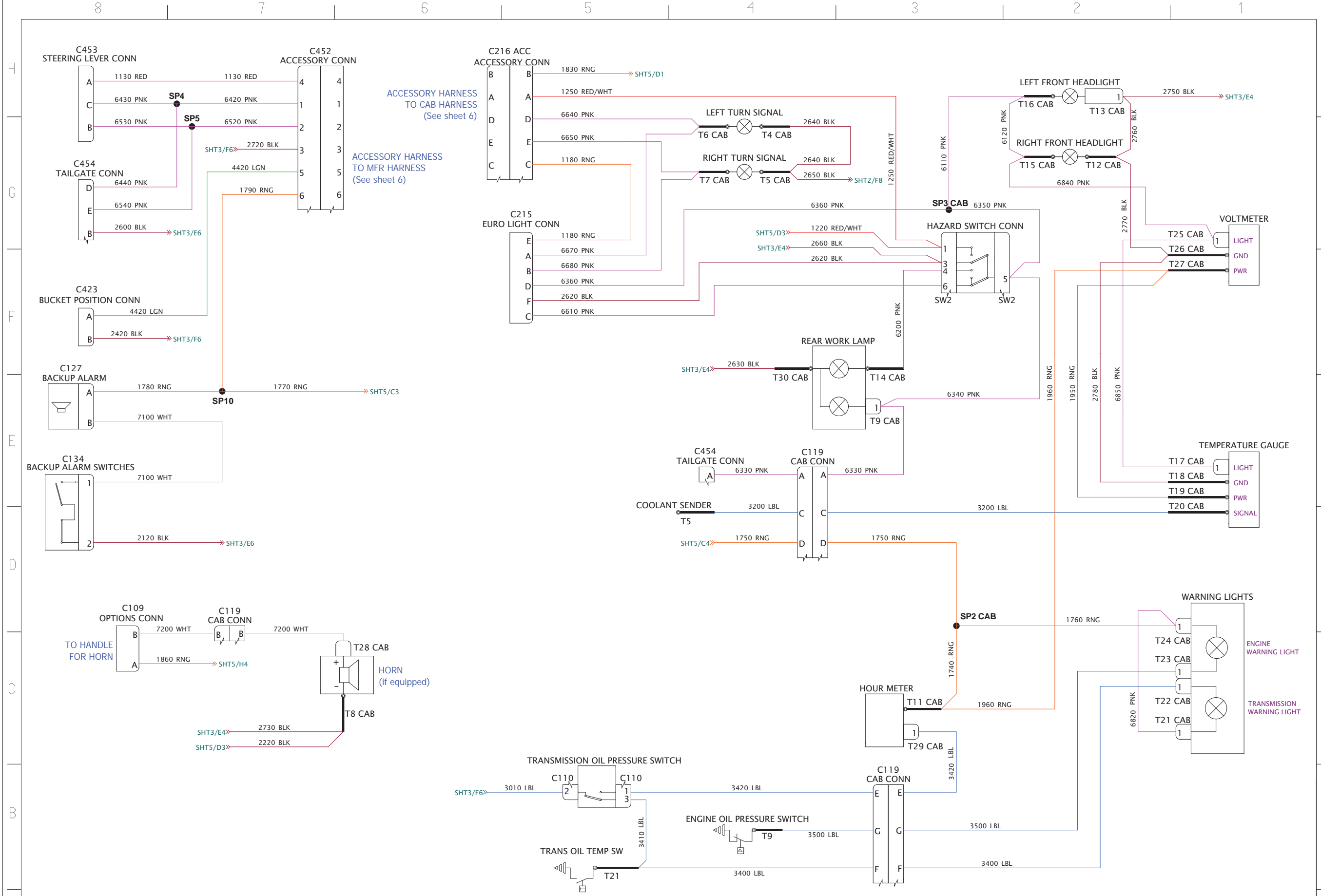

Wiring Schematic
Standard Machine

S70

S/N B38V15917 & Above
S/N B38W13306 & Above
S/N B4TY11001 & Above
S/N B4UC11001 & Above

Printed On October 2019

[Printable Version Click Here](#)

7336048 (A)
Sheet 4 of 8

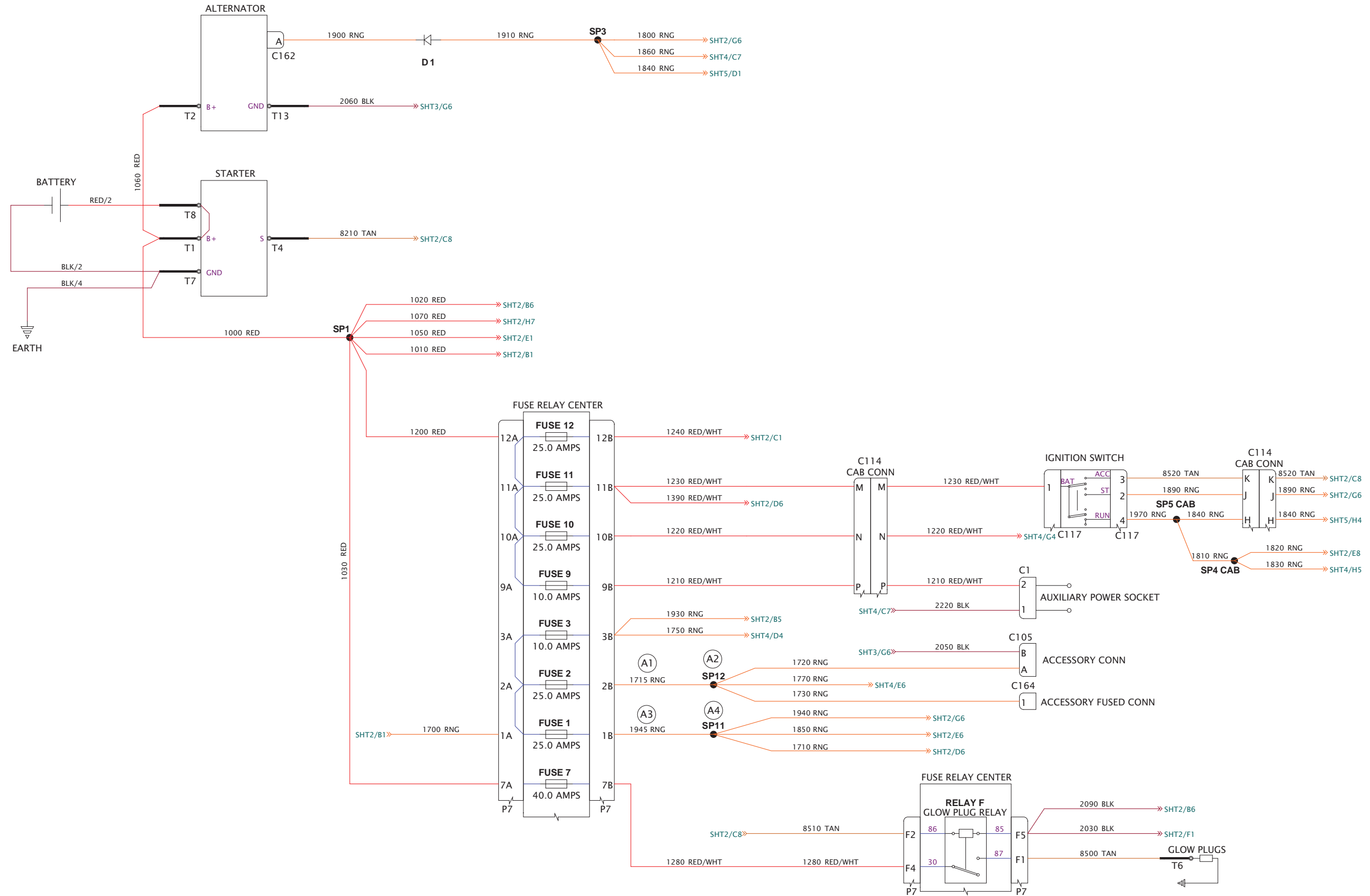

Wiring Schematic
Standard Machine

S70

S/N B38V15917 & Above
S/N B38W13306 & Above
S/N B4TY11001 & Above
S/N B4UC11001 & Above

Printed On October 2019

[Printable Version Click Here](#)

7336048 (A)
Sheet 5 of 8

ACCESSORY HARNESS

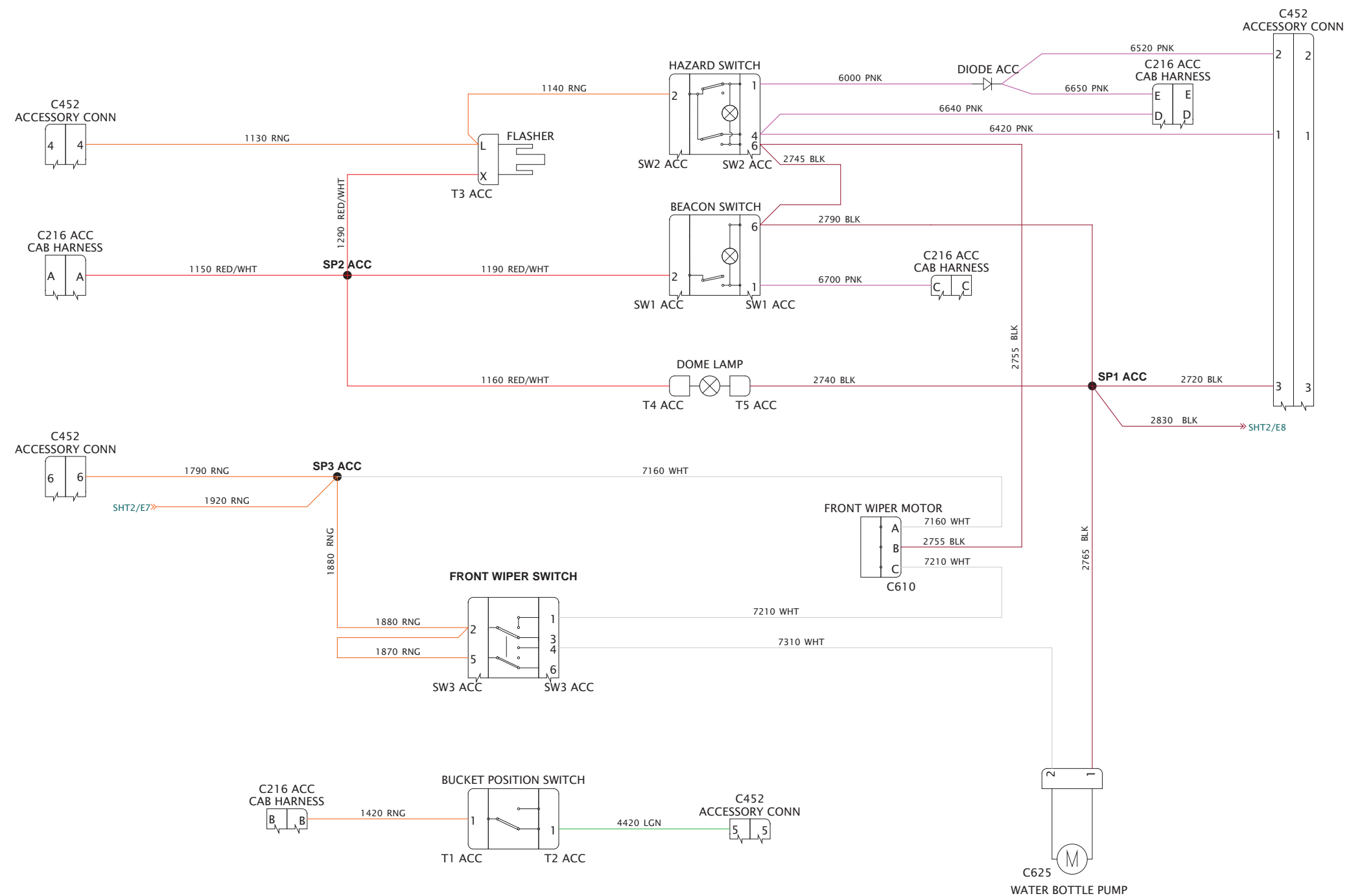

Wiring Schematic
Standard Machine

S70

S/N B38V15917 & Above
S/N B38W13306 & Above
S/N B4TY11001 & Above
S/N B4UC11001 & Above

Printed On October 2019

[Printable Version Click Here](#)

7336048 (A)
Sheet 6 of 8

HARNESS RENTAL, PN 7167049

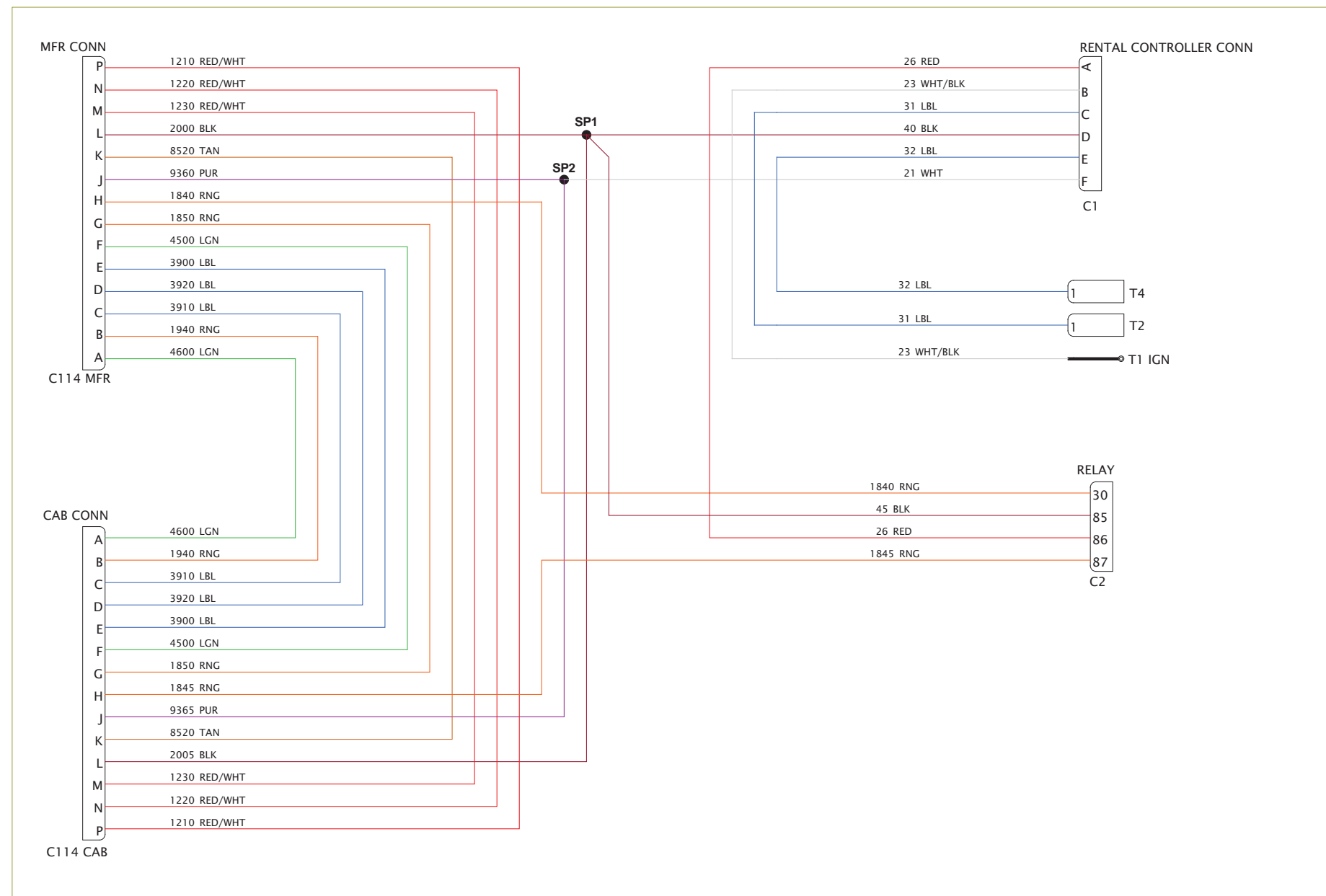

HARNESS BACKUP ALARM, PN 7172891

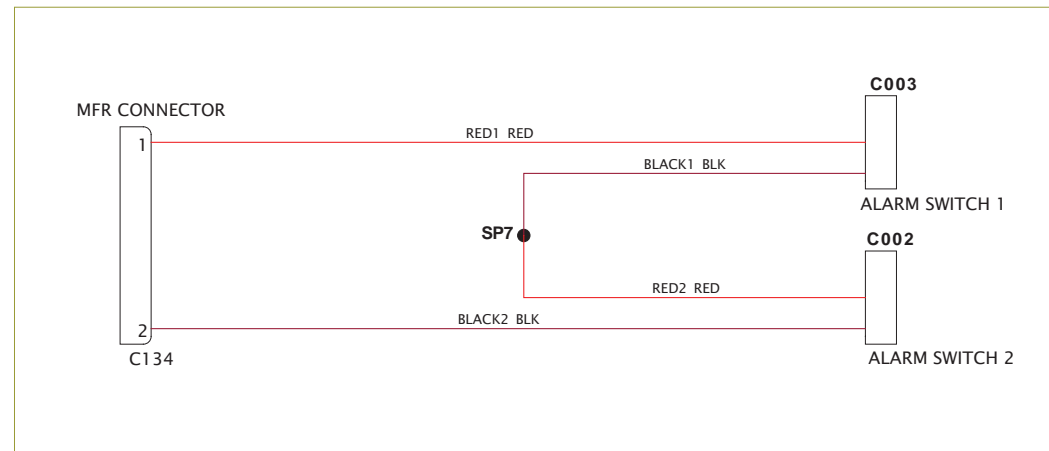



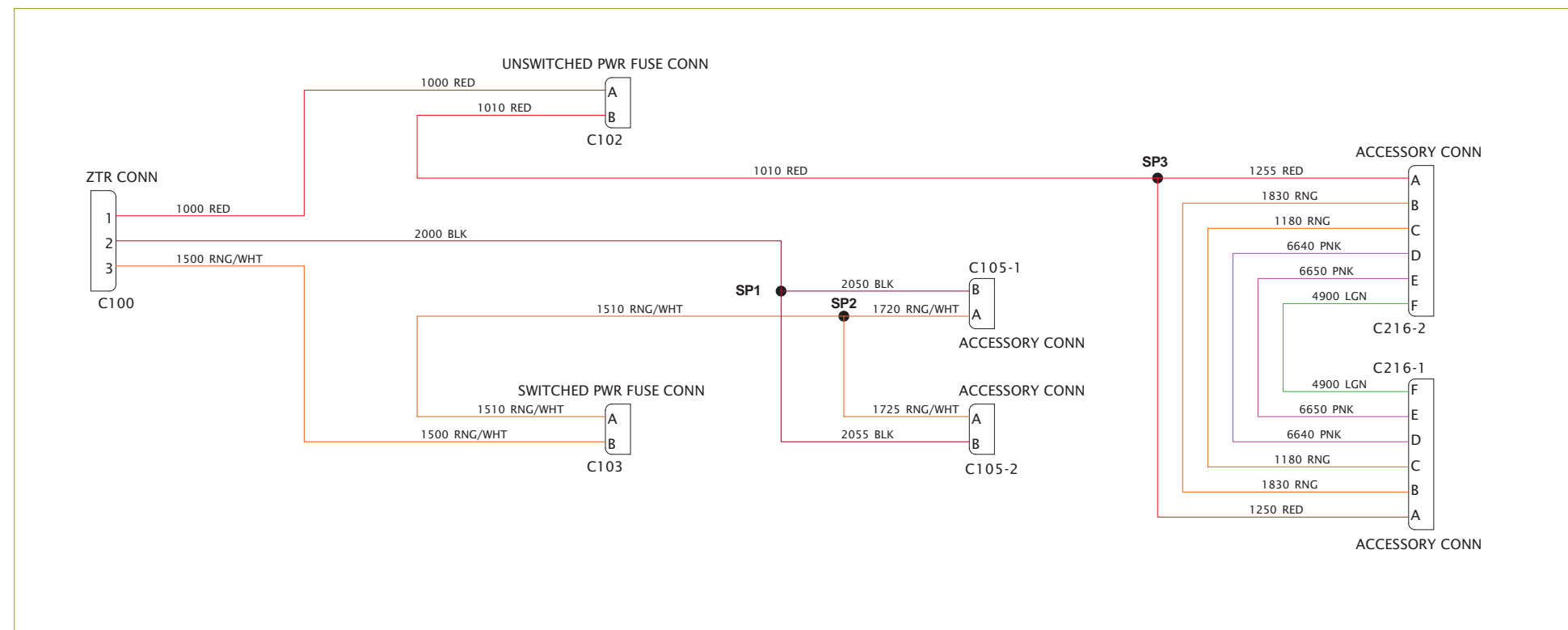





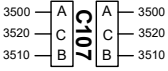
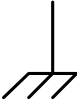
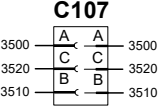
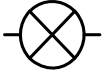

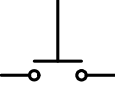

HARNESS ZTR, PN 7271334

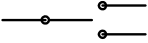



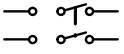







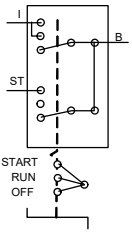
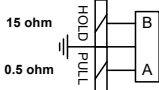
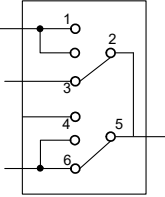

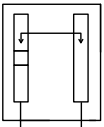
ELECTRICAL SYSTEM INFORMATION

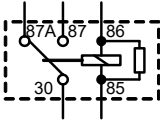
Glossary Of Electrical Symbols

SYMBOL	DESCRIPTION	SYMBOL	DESCRIPTION
CONNECTIONS			
	<p>CONNECTOR - Harness - Used for connecting 2 harnesses together or a harness to a component. The connector can vary from a single pin to any number of pins (Example: 3 pin connectors shown). The connector pins can be numbered alphabetical (shown) or numerical (1, 2, 3 etc.). The harness wires numbers are called out next to the connector (Example: 3500).</p>		<p>GROUND - Frame - Used to represent an component that is internally grounded.</p>
	<p>The connector number is called out next to the connector (Example: C107). These connector numbers are used for schematic identification only and do not appear on the harness or connector.</p>		<p>LIGHT -</p>
COMPONENTS			
	<p>BATTERY - Used for supplying and storing electrical power for the machine.</p>		<p>SWITCH - Single Pole - Single Throw (ON-OFF) Normally Open</p>
	<p>POSITIVE ELECTRICAL CIRCUIT - Indicates positive battery circuit.</p>		<p>SWITCH - Single Pole - Single Throw (ON-OFF) Normally Closed</p>
	<p>NEGATIVE ELECTRICAL CIRCUIT - Indicates battery ground circuit.</p>		<p>SWITCH - Single Pole - Double Throw (ON-OFF-ON) - This switch can be in any of three positions. (Some switches are spring activated to return them to a certain position when released.)</p>
	<p>ALTERNATOR - Used to create the electrical current to supply voltage to the battery and components.</p>		<p>SWITCH - Double Pole - Single Throw (ON-OFF) Open and Closed positions will be specified depending on switch application.)</p>
	<p>STARTER - Uses battery current to start the machine engine.</p>		<p>SWITCH - Double Pole - Double Throw (ON-OFF) Open and Closed positions will be specified depending on switch application.</p>
	<p>GROUND - Used to represent an external ground connection.</p>		<p>POTENTIOMETER - Variable resistance - Provides variable resistance.</p>

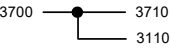
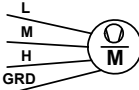
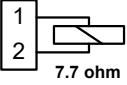
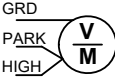
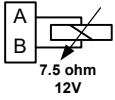
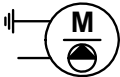
ELECTRICAL SYSTEM INFORMATION (CONT'D)

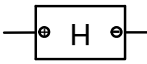
Glossary Of Electrical Symbols (Cont'd)

SYMBOL	DESCRIPTION	SYMBOL	DESCRIPTION
COMPONENTS			
	SWITCH - Key - Multi position switch to activate various start functions at different positions.		SOLENOID - Fuel and Traction Lock - Dual solenoids. (The ohm rating of the solenoid coils are listed next to the component [if available]). The pull solenoid is energized for a short time.
	SWITCH - Light - Multi position switch to activate various lights at different positions.		HORN - Audible alarm. Sound is activated manually by a switch to warn personnel.
	ROTARY CONTROL - Provides variable voltage proportional to position.		BUZZER - Audible alarm. Sounds at a predetermined setting to warn the operator of a component condition.
	RELAY - Uses a low amp switch to control a high amp component.		RESISTOR - Limits current flow.
	FUSE - Used to protect the wire harness from an overloaded circuit. (The fuse rating is listed next to the fuse.)		DIODE - Allows electrical current to flow in 1 direction only.
	SPLICE (•) - Used to show when multiple wires are connected together on the schematic.		MOTOR - HVAC - Multi speed motor.
	SOLENOID - ON / OFF - Electrically activated coil that controls movement magnetically. (The ohm rating of the solenoid coil is listed next to the component [if available]).		MOTOR - Wiper - Single or multi speed motor.
	SOLENOID - VARIABLE - Electrically activated coil that controls movement magnetically. (The ohm rating and voltage of the solenoid coil is listed next to the component [if available]).		MOTOR - Washer - Single speed.
			PUMP - FUEL
			HOURMETER - Records the time the engine is running.
			POWER PLUG - Supplies 12 volt power for customer supplied accessories.
			GAUGE - Instrument - Indicates certain engine or other component conditions. (The different types of gauge are marked with a icon that represents what function the gauge is monitoring. Example: the gauge shown is for fuel.)

ELECTRICAL SYSTEM INFORMATION (CONT'D)

Glossary Of Electrical Symbols (Cont'd)

SYMBOL

DESCRIPTION

SENDERS AND SENSORS

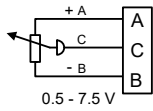

PRESSURE SENDER - Provides a variable voltage proportional to pressure. (Sender voltage rating is listed to show volts at high and low setting.)

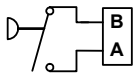

PRESSURE SWITCH - Switch opens or closes at a predetermined pressure to activate a function or to turn on a warning light. (Switch is shown in the open position.)

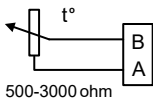

TEMPERATURE SENDER - Provides a variable resistance (ohm) signal proportional to temperature. (Sender ohm rating is listed to show ohms at high and low setting.)

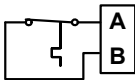

TEMPERATURE SWITCH - The switch opens or closes at a predetermined temperature to activate a function or to turn on a warning light. (Switch is shown in the closed position.)

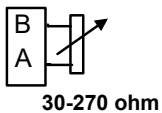

FUEL SENDER - Provides a variable resistance, based on the fuel level in the tank. (Sender ohm rating is listed to show ohms at full and empty setting.)

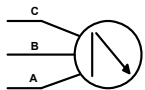

HALL EFFECT SENSOR - Detects linear or rotary position and provides a proportional variable voltage.

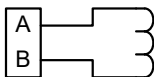

SPEED SENSOR - magnetic pickup - detects RPM.

ELECTRICAL SYSTEM INFORMATION (CONT'D)

Cab Harness Connectors

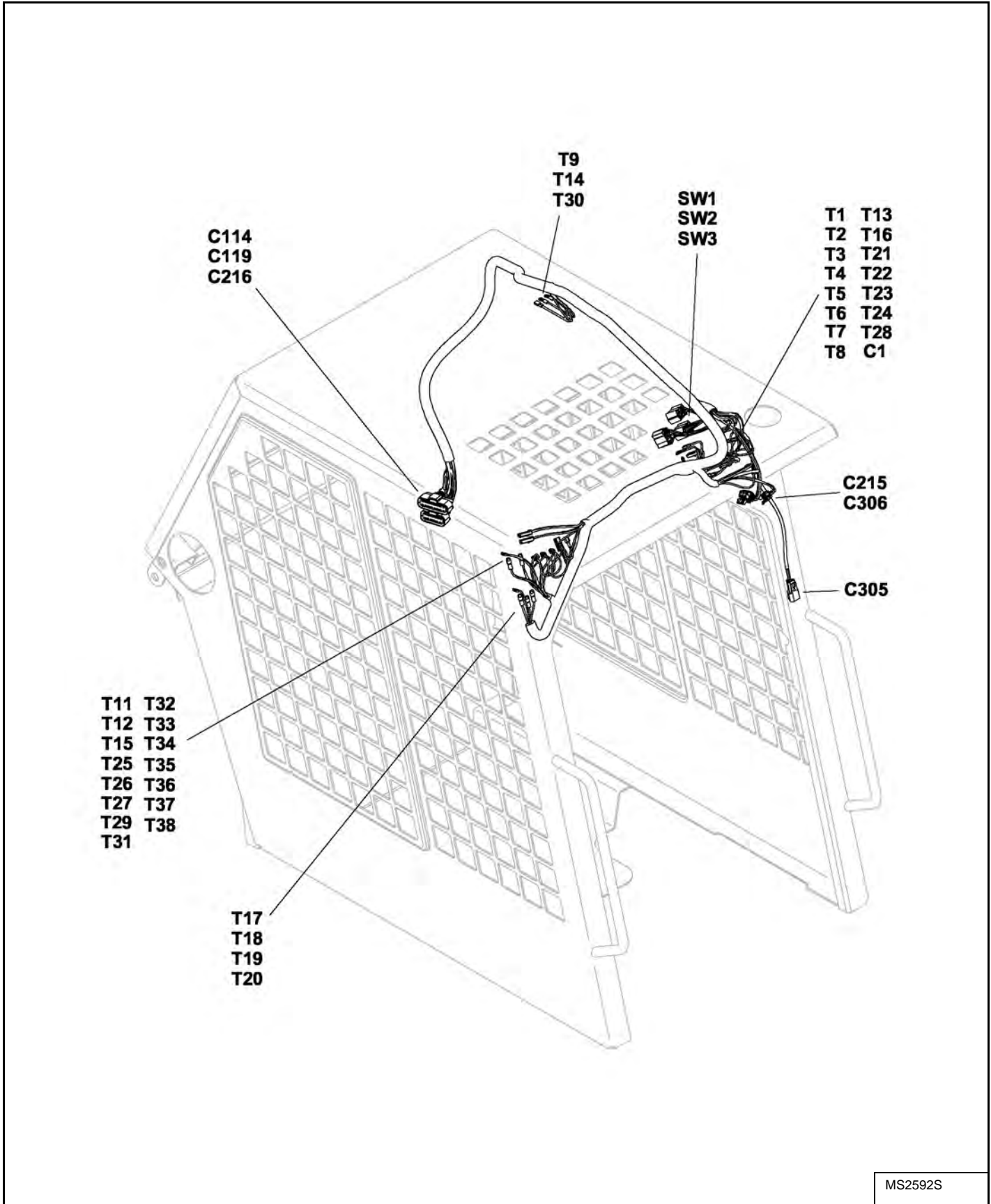

MS2592S

ELECTRICAL SYSTEM INFORMATION (CONT'D)

Mainframe Harness Connectors

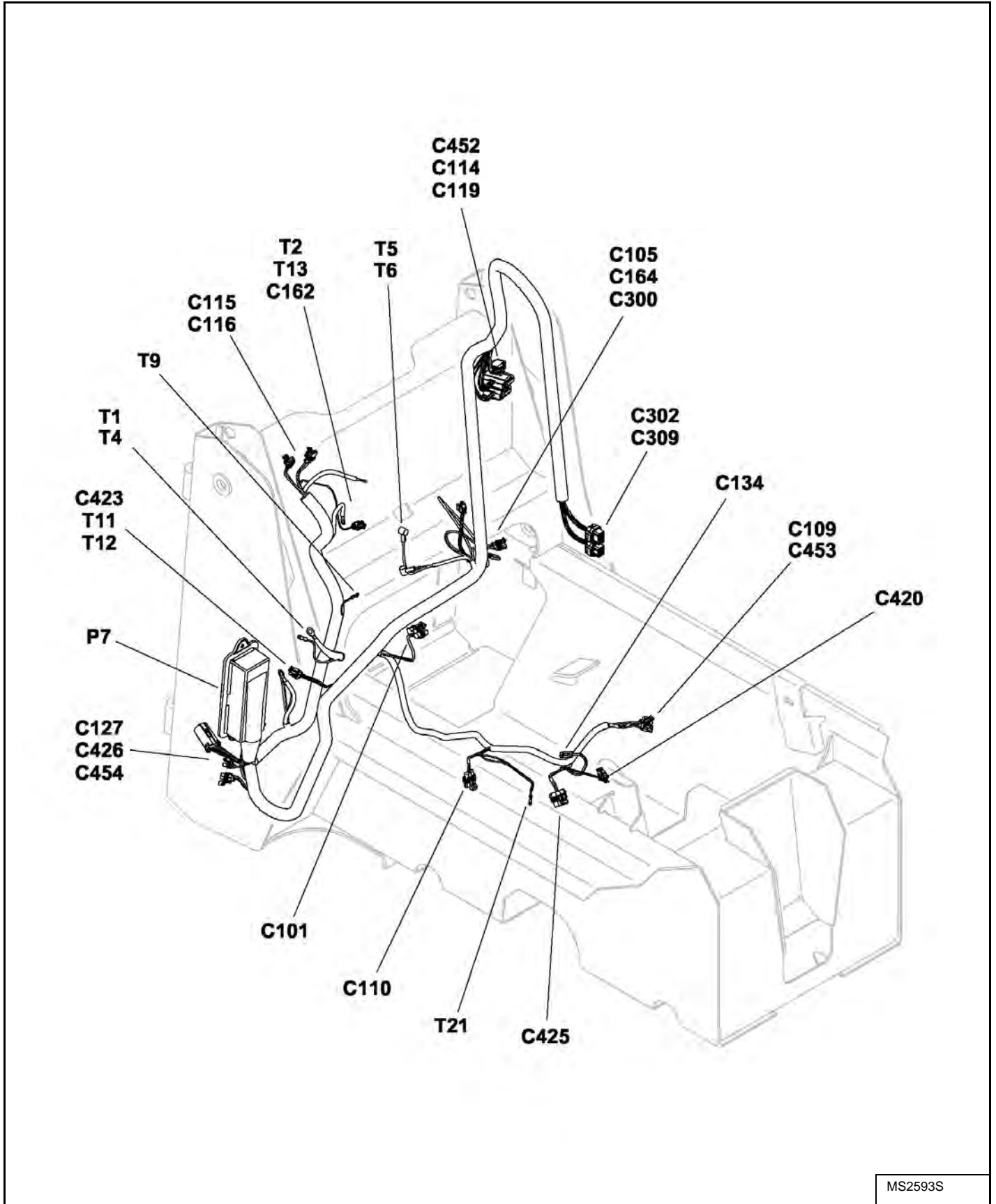

MS2593S

ELECTRICAL SYSTEM INFORMATION (CONT'D)

Description

The loader has a 12 volt, negative ground alternator charging system. The electrical system is protected by fuses located in the engine compartment. The fuses will protect the electrical system when there is an electrical overload. The reason for the overload must be found before starting the engine again.

ELECTRICAL SYSTEM INFORMATION (CONT'D)

Troubleshooting

The Following Troubleshooting Chart Is Provided For Assistance In Locating And Correcting Problems Which Are Most Common. Many Of The Recommended Procedures Must Be Done By Authorized Bobcat Service Personnel Only.



WARNING

Check for correct function after adjustments, repairs or service. Failure to make correct repairs or adjustments can cause injury or death.

W-2004-1285

PROBLEM	CAUSE
Battery loses charge.	1, 2, 3, 4, 5
Alternator will not charge.	1, 2, 5
Starter will not turn engine.	2, 3, 4, 6, 7, 8, 9

KEY TO CORRECT THE CAUSE
1. Alternator belt is loose or damaged.
2. Battery connections are dirty or loose.
3. Battery is defective.
4. The ground is not correct in the electrical system.
5. The alternator has a defect.
6. Engine seizure.
7. Starter has a defect.
8. Wiring or solenoid has a defect.
9. Fuse has a defect.

ELECTRICAL SYSTEM INFORMATION (CONT'D)

Fuse And Relay Location / Identification

Figure 60-10-1

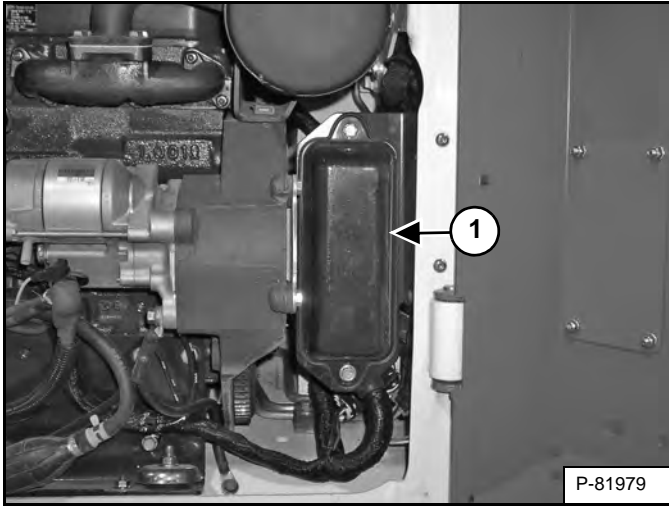

The electrical system is protected from overload by fuses and relays under the fuse panel cover (Item 1) [Figure 60-10-1]. A decal is inside the cover to show location and amperage ratings.

Figure 60-10-2



Remove the cover to check or replace the fuses [Figure 60-10-2].

Figure 60-10-3

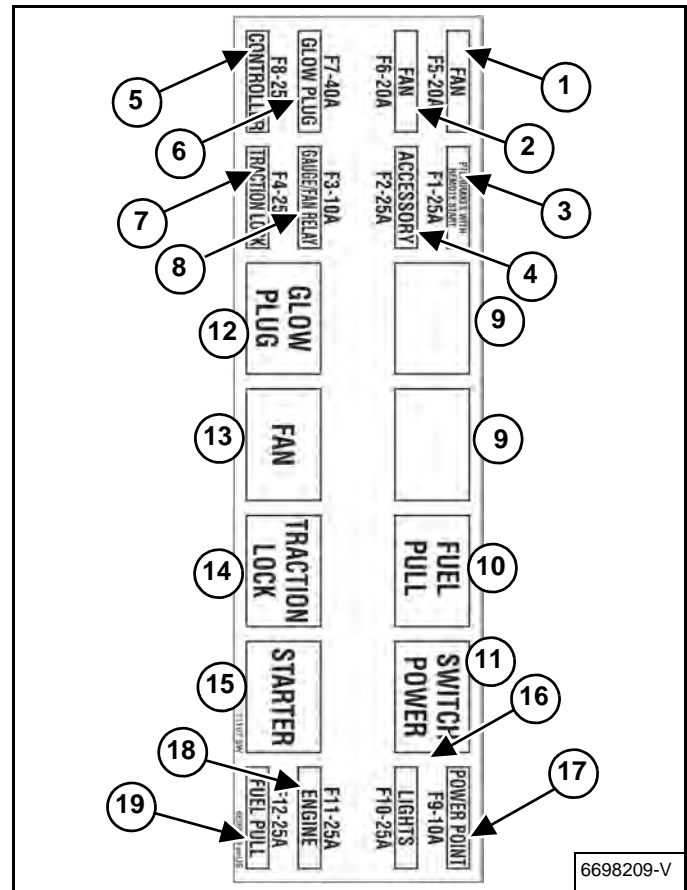

There is a decal [Figure 60-10-3] inside the fuse panel cover which shows location and size of fuses. Description and amp ratings (or relays) are also shown below.

REF.	DESCRIPTION	AMPS	REF.	DESCRIPTION	AMPS
1	Fan	20	10	Fuel Solenoid	R
2	Fan	20	11	Switched Power	R
3	BICS™ / Brakes / Remote Start	25	12	Glow Plug	R
4	Accessory Back-up Alarm	25	13	Fan	R
5	Controller	25	14	Traction Lock	R
6	Glow Plug	40	15	Starter	R
7	Traction Lock	25	16	Lights	25
8	Gauge / Fan Relay	10	17	Power Point	10
9	Not Used	R	18	Engine / Horn	25
			19	Fuel Solenoid	25

R = Relay

ELECTRICAL SYSTEM INFORMATION (CONT'D)

Solenoid Testing

Figure 60-10-4



Use a test meter to measure coil resistance [**Figure 60-10-4**]. Coil wires do not have polarity. Correct resistance for the pressure relief (small) coil is 7 - 10 ohm and the other coils 5 - 8 ohm.

Replace the test meter with 12 volt power. You can see and hear the spool shift.



Bobcat®

BATTERY

Removal And Installation



AVOID INJURY OR DEATH

Batteries contain acid which burns eyes and skin on contact. Wear goggles, protective clothing and rubber gloves to keep acid off body.

In case of acid contact, wash immediately with water. In case of eye contact get prompt medical attention and wash eye with clean, cool water for at least 15 minutes.

If electrolyte is taken internally drink large quantities of water or milk! DO NOT induce vomiting. Get prompt medical attention.

W-2065-0807

Open the rear door.

Figure 60-20-1

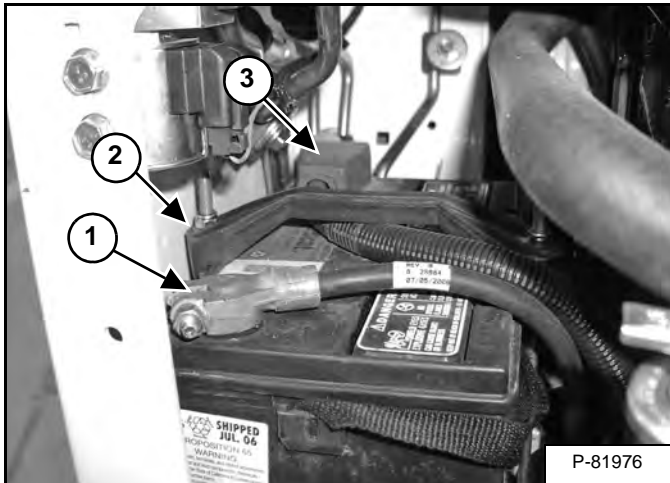

Disconnect the negative (-) battery cable (Item 1) [Figure 60-20-1].

Remove the battery hold down clamp (Item 2) [Figure 60-20-1].

Disconnect the positive (+) cable (Item 3) [Figure 60-20-1] from the battery.

Remove the battery from the loader.

NOTE: When removing or installing the battery in the loader, do not touch any metal parts with the battery terminals.

Figure 60-20-2

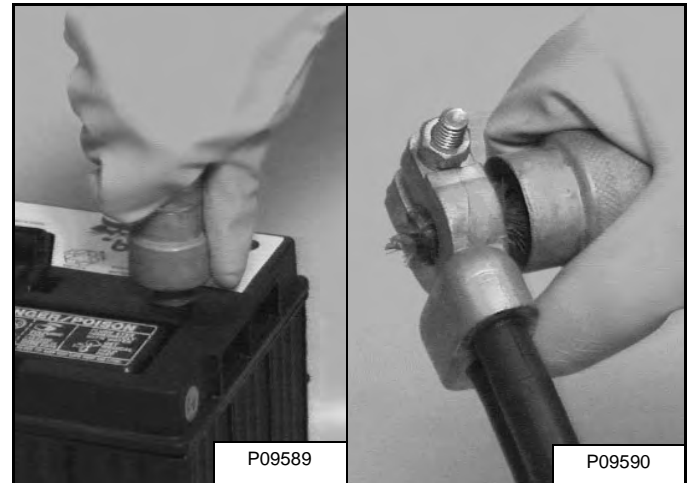

Always clean the battery terminals and cable ends when installing a new or used battery [Figure 60-20-2].

NOTE: Always connect the negative (-) cable last and remove it first to prevent sparks.

Connect the positive (+) battery cable. Tighten the nut to 5,4 - 6,8 N•m (4 - 5 ft-lb).

Install and tighten the battery hold down clamp.

Connect the negative (-) battery cable. Tighten the nut to 5,4 - 6,8 N•m (4 - 5 ft-lb).

Close the rear door before operating the loader.

BATTERY (CONT'D)

Battery Maintenance

See the SERVICE SCHEDULE for the correct service interval. (See SERVICE SCHEDULE on Page 10-70-1.)

The Bobcat brand battery supplied with your machine is sealed and does not require watering. Proper charging and storage are important to maximize the life of all batteries.

Figure 60-20-3

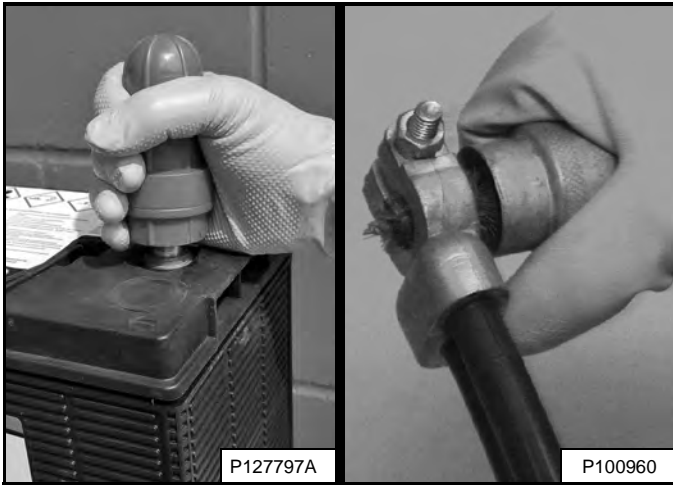

Simple steps for reliability and long battery life:

- Keep battery posts and terminals clean **[Figure 60-20-3]**.
- Keep terminals tight.
- Remove corrosion from battery and terminals with sodium bicarbonate (baking soda) and water solution.
- Put Bobcat Battery Saver or grease on the battery terminals and cable ends to prevent corrosion.
- Operate the machine for at least 15 minutes to recover from the battery drain caused by engine startup whenever practical.
- Maintain the battery charge level. This is a key factor for long battery life.
- Charge a severely discharged battery with a battery charger instead of relying on the machine charging system. (See Battery Charging on Page 60-20-3.)
- Check the battery state of charge every 30 days on machines that are not frequently used. (See Battery Testing on Page 60-20-3.)

WARNING

AVOID INJURY OR DEATH

Batteries contain acid which burns eyes and skin on contact. Wear goggles, protective clothing and rubber gloves to keep acid off body.

In case of acid contact, wash immediately with water. In case of eye contact get prompt medical attention and wash eye with clean, cool water for at least 15 minutes.

If electrolyte is taken internally drink large quantities of water or milk! DO NOT induce vomiting. Get prompt medical attention.

W-2065-0807

Maintaining Battery Charge Level

All batteries will self-discharge over time. This machine has features that require battery power even when the machine is not being used. Use of a quality battery maintainer is highly recommended to ensure that your machine is ready to start when you need it and avoid costly battery replacement.

Battery Maintainers

Use a good quality battery maintainer to keep the battery above 12.4 volts for machines that are not frequently used. Batteries below 12.4 volts must first be charged using a battery charger. Solar maintainers should have a minimum capacity of 10 watts to be effective.

Battery Service During Machine Storage

Remove the battery if storing the machine for an extended period of time. Fully charge the battery. Store the battery in a cool dry place above freezing and boost charge periodically. If battery removal is not desired, a good quality battery maintainer must be used to compensate for battery self-discharge and parasitic loads from machine controllers, accessories, and features such as connected machine intelligence.

ELECTRICAL SYSTEM (CONT'D)

Battery Testing

Figure 60-20-4

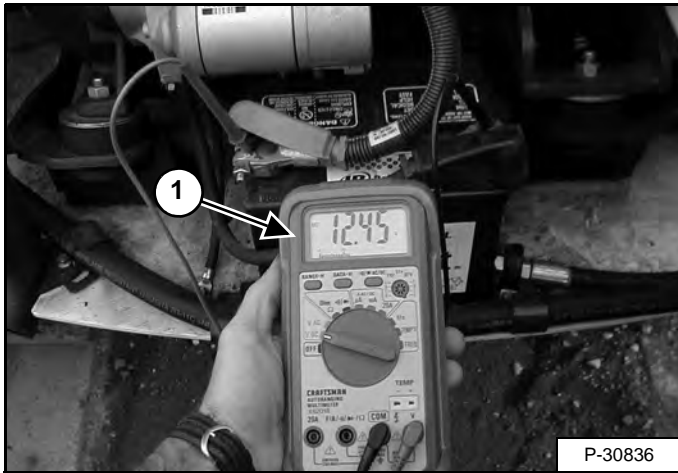

The simplest and most common check to determine battery state of charge is to use a digital multimeter or voltmeter (Item 1) [Figure 60-20-4].

A battery found below 12.4 volts must be charged to 100% charge per the battery charger's recommendation. **Allow at least 60 minutes after operating the machine or charging the battery to get an accurate reading.**

If the reading is less than 12.4 volts after the battery has been charged for several hours, see your Bobcat dealer to have a more thorough battery test performed.

The freezing point of battery electrolyte is dependent on the battery state of charge. Keeping the battery voltage above 12.4 volts will help prevent batteries from freezing, even at extremely low temperatures.

If the battery freezes, the internal grid may be damaged and the case will be distorted or cracked. If this happens, dispose of the battery according to local regulations.

Battery Charging

A battery charger designed for 12 volt charging systems is recommended. Follow the battery charger manufacturer's instructions to charge the battery to 12.6 volts (100% charge). Batteries should be charged at room temperature to avoid an undercharge or overcharge condition. Never attempt to charge a frozen battery.

The following table can be used to identify the approximate amount of time required to charge a discharged battery. Allow at least 60 minutes after operating the machine or charging the battery to get an accurate reading.

BATTERY VOLTAGE	STATE OF CHARGE	CHARGER MAXIMUM RATE		
		30 Amps	20 Amps	10 Amps
12.6 V	100%	READY TO USE		
12.4 V	75%	0.9 hr.	1.3 hr.	2.5 hr.
12.2 V	50%	1.9 hr.	2.7 hr.	5.1 hr.
12.0 V	25%	2.9 hr.	4.3 hr.	7.8 hr.
11.8 V	0%	4.0 hr.	5.7 hr.	10.7 hr.

NOTE: Use a good quality automatic charger to avoid battery damage from overcharging.



BATTERY GAS CAN EXPLODE AND CAUSE SERIOUS INJURY OR DEATH

Keep arcs, sparks, flames and lighted tobacco away from batteries. When *jumping* from booster battery make final connection (negative) at machine frame.

Do not jump start or charge a frozen or damaged battery. Warm battery to 16°C (60°F) before connecting to a charger. Unplug charger before connecting or disconnecting cables to battery. Never lean over battery while boosting, testing or charging.

W-2066-0910

ELECTRICAL SYSTEM (CONT'D)

Using A Booster Battery (Jump Starting)

If it is necessary to use a booster battery to start the engine, BE CAREFUL! There must be one person in the operator's seat and one person to connect and disconnect the battery cables.

Figure 60-20-5

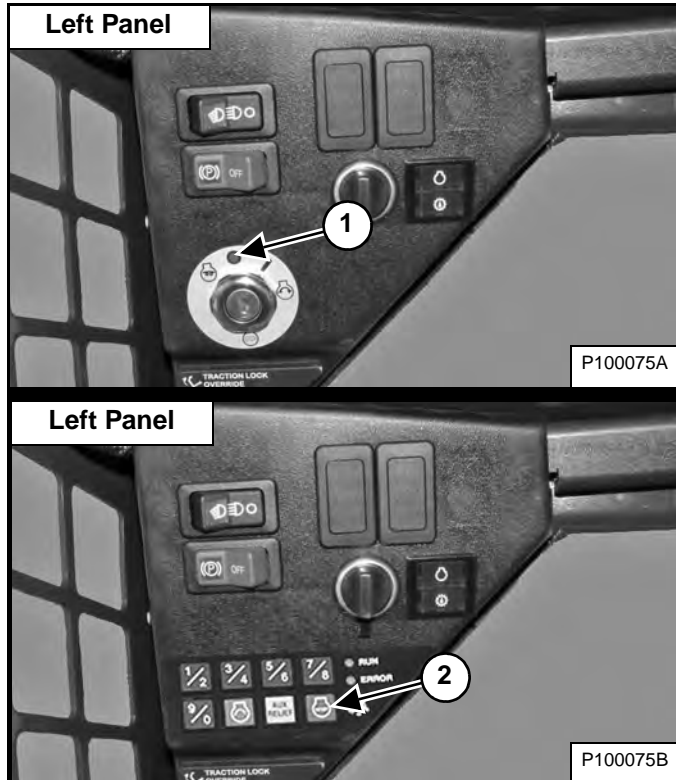

The key switch (Item 1) must be in the OFF position or the STOP button (Item 2) [Figure 60-20-5] must be pressed. The booster battery must be 12 volt.

WARNING

BATTERY GAS CAN EXPLODE AND CAUSE SERIOUS INJURY OR DEATH

Keep arcs, sparks, flames and lighted tobacco away from batteries. When *jumping* from booster battery make final connection (negative) at machine frame.

Do not jump start or charge a frozen or damaged battery. Warm battery to 16°C (60°F) before connecting to a charger. Unplug charger before connecting or disconnecting cables to battery. Never lean over battery while boosting, testing or charging.

W-2066-0910

WARNING

AVOID INJURY OR DEATH

Batteries contain acid which burns eyes and skin on contact. Wear goggles, protective clothing and rubber gloves to keep acid off body.

In case of acid contact, wash immediately with water. In case of eye contact get prompt medical attention and wash eye with clean, cool water for at least 15 minutes.

If electrolyte is taken internally drink large quantities of water or milk! DO NOT induce vomiting. Get prompt medical attention.

W-2065-0807

ELECTRICAL SYSTEM (CONT'D)

Using A Booster Battery (Jump Starting) (Cont'd)

Figure 60-20-6

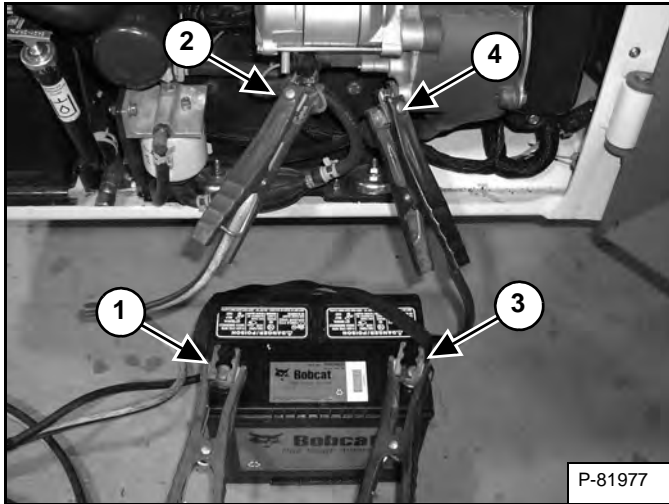

Connect the end of the first cable to the positive (+) terminal (Item 1) of the booster battery. Connect the other end of the same cable to the positive terminal (Item 2) [Figure 60-20-6] on the loader starter.

Connect the end of the second cable to the negative (-) terminal (Item 3) of the booster battery. Connect the other end of the same cable (Item 4) [Figure 60-20-6] to the engine.

NOTE: Keep cables away from moving parts.

Start the engine.

After the engine has started, remove the negative (-) cable (Item 4) [Figure 60-20-6] first.

Remove the cable from the positive terminal (Item 2) [Figure 60-20-6].

IMPORTANT

Damage to the alternator can occur if:

- Engine is operated with battery cables disconnected.
- Battery cables are connected when using a fast charger or when welding on the loader. (Remove both cables from the battery.)
- Extra battery cables (booster cables) are connected wrong.

I-2023-1285

ELECTRICAL SYSTEM (CONT'D)

Removing And Installing Battery

! WARNING

AVOID INJURY OR DEATH

Batteries contain acid which burns eyes and skin on contact. Wear goggles, protective clothing and rubber gloves to keep acid off body.

In case of acid contact, wash immediately with water. In case of eye contact get prompt medical attention and wash eye with clean, cool water for at least 15 minutes.

If electrolyte is taken internally drink large quantities of water or milk! DO NOT induce vomiting. Get prompt medical attention.

W-2065-0807

Open the rear door.

Figure 60-20-7

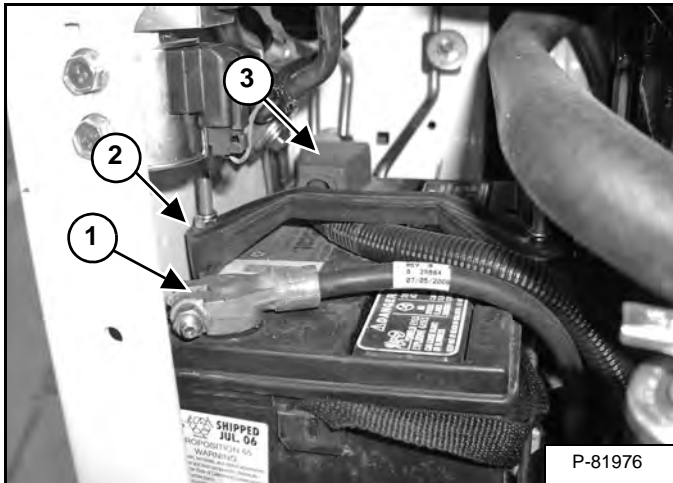

Disconnect the negative (-) battery cable (Item 1) [Figure 60-20-1].

Remove the battery hold-down clamp (Item 2) [Figure 60-20-1].

Disconnect the positive (+) cable (Item 3) [Figure 60-20-1] from the battery.

Remove the battery from the loader.

NOTE: When removing or installing the battery in the loader, do not touch any metal parts with the battery terminals.

Figure 60-20-8

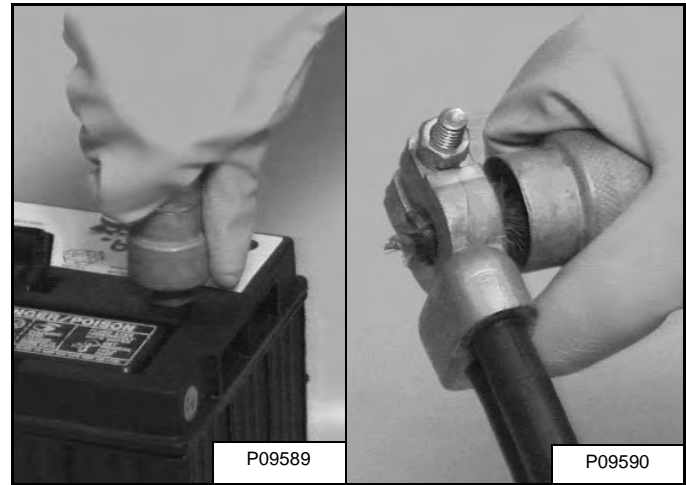

Always clean the battery terminals and cable ends when installing a new or used battery [Figure 60-20-2].

NOTE: Always connect the negative (-) cable last and remove it first to prevent sparks.

Connect the positive (+) battery cable. Tighten the nut to 5,4 – 6,8 N•m (4 – 5 ft-lb) torque.

Install and tighten the battery hold-down clamp.

Connect the negative (-) battery cable. Tighten the nut to 5,4 – 6,8 N•m (4 – 5 ft-lb) torque.

Close the rear door before operating the loader.

ALTERNATOR

Belt Adjustment

Stop the engine and raise the operator cab. (See Raising on Page 10-30-2.)

Open the rear door.

Figure 60-30-1

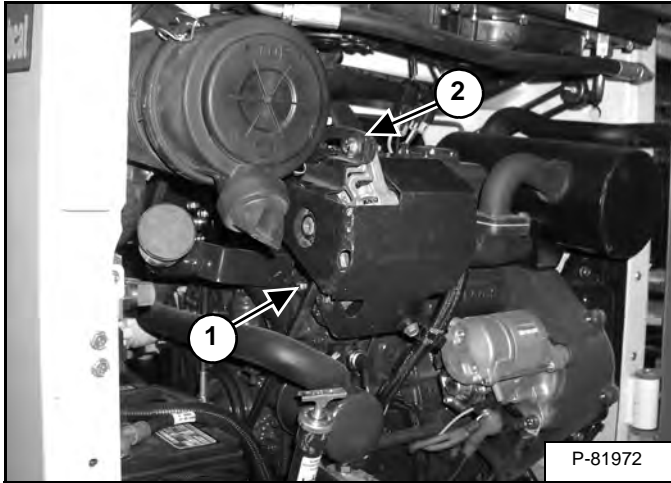

Loosen the alternator mounting bolt (Item 1) **[Figure 60-30-1]**.

Loosen the adjustment bolt (Item 2) **[Figure 60-30-1]**.

The tension is correct with 6 mm (1/4 in) belt movement at mid span when 67 N (15 lb) force is applied to the belt.

Tighten the adjustment and mounting bolts.

Stop the engine and lower the operator cab. (See Lowering on Page 10-30-3.)

Belt Replacement

Stop the engine and exit the loader.

Open the rear door.

Loosen the alternator mounting and adjustment bolts (Items 1 and 2) **[Figure 60-30-1]** and loosen the belt all the way.

Remove the belt and install a new belt.

The tension is correct with 6 mm (1/4 in) belt movement at mid span when 67 N (15 lb) force is applied to the belt.

Tighten the adjustment bolt and mounting bolts.

Stop the engine and lower the operator cab. (See Lowering on Page 10-30-3.)

ALTERNATOR (CONT'D)

Charging System Inspection

WARNING

AVOID INJURY OR DEATH

Batteries contain acid which burns eyes and skin on contact. Wear goggles, protective clothing and rubber gloves to keep acid off body.

In case of acid contact, wash immediately with water. In case of eye contact get prompt medical attention and wash eye with clean, cool water for at least 15 minutes.

If electrolyte is taken internally drink large quantities of water or milk! DO NOT induce vomiting. Get prompt medical attention.

W-2065-0807

WARNING

BATTERY GAS CAN EXPLODE AND CAUSE SERIOUS INJURY OR DEATH

Keep arcs, sparks, flames and lighted tobacco away from batteries. When *jumping* from booster battery make final connection (negative) at machine frame.

Do not jump start or charge a frozen or damaged battery. Warm battery to 16°C (60°F) before connecting to a charger. Unplug charger before connecting or disconnecting cables to battery. Never lean over battery while boosting, testing or charging.

W-2066-0910

IMPORTANT

Damage to the alternator can occur if:

- Engine is operated with battery cables disconnected.
- Battery cables are connected when using a fast charger or when welding on the loader. (Remove both cables from the battery.)
- Extra battery cables (booster cables) are connected wrong.

I-2023-1285

If the charging system malfunctions check the following:

Check the condition and tension of the alternator belt. (See Belt Adjustment on Page 60-30-1.) Replace belt if worn or deteriorated.

Inspect the alternator wiring harness and connectors at alternator. Harness and connectors must be clean and tight.

Check the fuse for the alternator in the fuse panel. If fuse is burned, find the cause and repair / replace. If fuse is in doubt, remove it and check for continuity.

Check the electrolyte level in the battery. Add distilled water as needed. (Does not apply to maintenance free batteries.)

Verify the charge of the battery. Make sure battery is fully charged.

Disconnect the battery cables (negative first, then positive). Inspect the cable clamps and battery posts for corrosion. Remove acid or corrosion from the battery and cables with a sodium bicarbonate and water solution. Put grease on the cable ends and battery terminals to prevent corrosion. Reconnect the cable to the positive terminal.

ALTERNATOR (CONT'D)

Alternator Voltage Testing

Figure 60-30-2

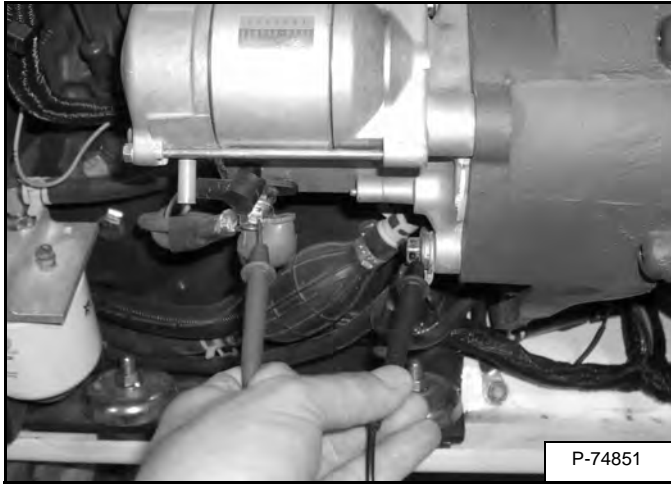

Open the rear door.

Connect the Remote Start Tool to the loader. (See REMOTE START TOOL KIT - MEL1563 on Page 10-60-1.) or (See REMOTE START TOOL (SERVICE TOOL) KIT -7217666 on Page 10-61-1.)

Turn the engine on with the Remote Start Tool and run at idle. With a voltmeter, check the voltage between the B+ terminal and ground at the starter [Figure 60-30-2].

The voltage must be higher than 13.5 volts but lower than 14.7 volts at 21°C (70°F) (Alternator Temperature).

If the voltage is higher than 14.7 volts proceed to the following high voltage test.

If the voltage is lower than 13.5 volts, run the engine at high idle and recheck voltage. If the voltage is still below 13.5 volts, proceed with the following low voltage test.

IMPORTANT

Damage to the alternator can occur if:

- Engine is operated with battery cables disconnected.
- Battery cables are connected when using a fast charger or when welding on the loader. (Remove both cables from the battery.)
- Extra battery cables (booster cables) are connected wrong.

I-2023-1285

Low Voltage Testing

Figure 60-30-3

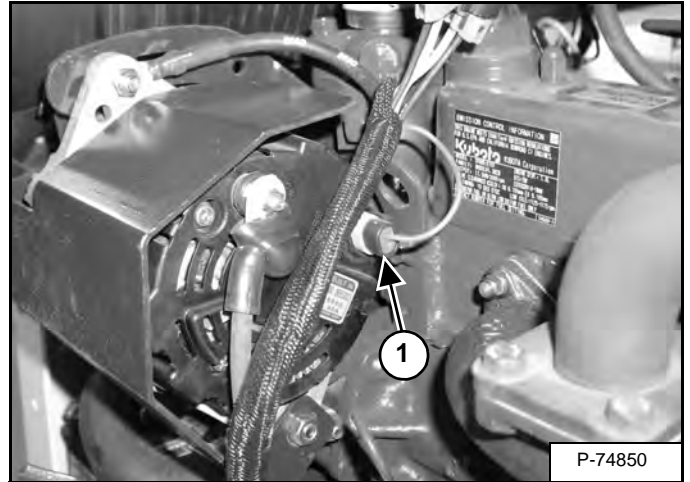

Turn the engine OFF and remove the L & R terminal connector (Item 1) [Figure 60-30-3] from the alternator.

Turn the Remote Start Tool key to the ON position.

Figure 60-30-4

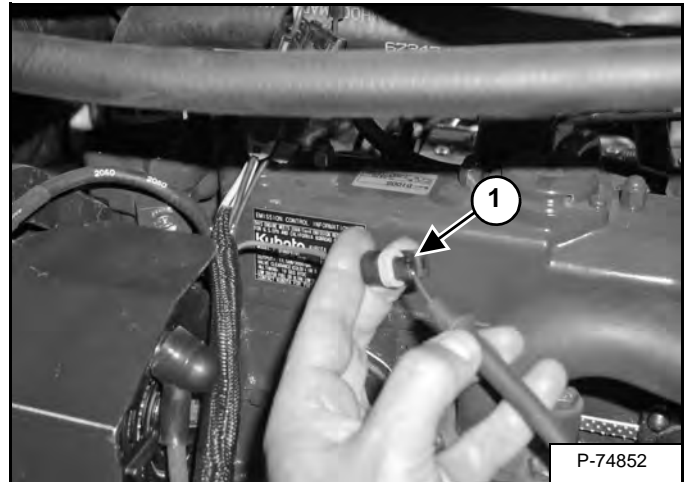

Check the voltage across the "R" terminal (Item 1) [Figure 60-30-4]. The voltage should be what the battery voltage is. If not, check wire harness, relay and fuses. If the wire harness, relay and fuses are okay then remove alternator for replacement or repair.

ALTERNATOR (CONT'D)

High Voltage Testing

Figure 60-30-5

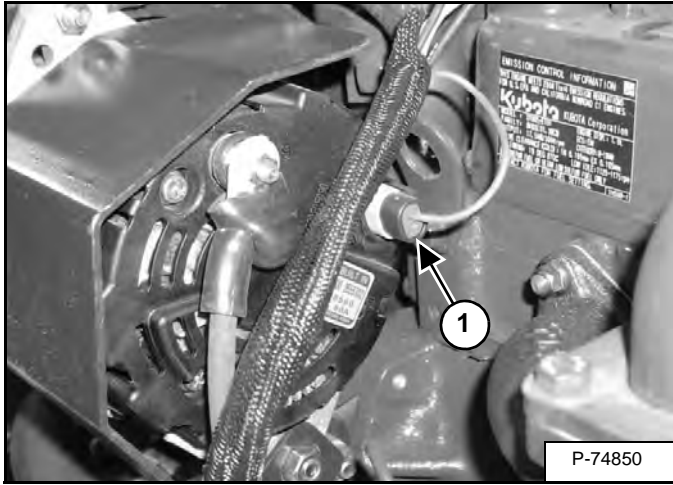

Turn the engine OFF and remove the L & R terminal connector (Item 1) **[Figure 60-30-5]** from the alternator.

Check the continuity between the “R” terminal (Item 1) **[Figure 60-30-5]** and the positive (+) terminal on the battery. There should be continuity. If no continuity, replace wire harness.

If the voltage is still above 14.7 volts at 21°C (70°F) (Alternator Temperature), then remove alternator for replacement or repair.

ALTERNATOR (CONT'D)

Removal And Installation

IMPORTANT

Damage to the alternator can occur if:

- Engine is operated with battery cables disconnected.
- Battery cables are connected when using a fast charger or when welding on the loader. (Remove both cables from the battery.)
- Extra battery cables (booster cables) are connected wrong.

I-2023-1285

Figure 60-30-6

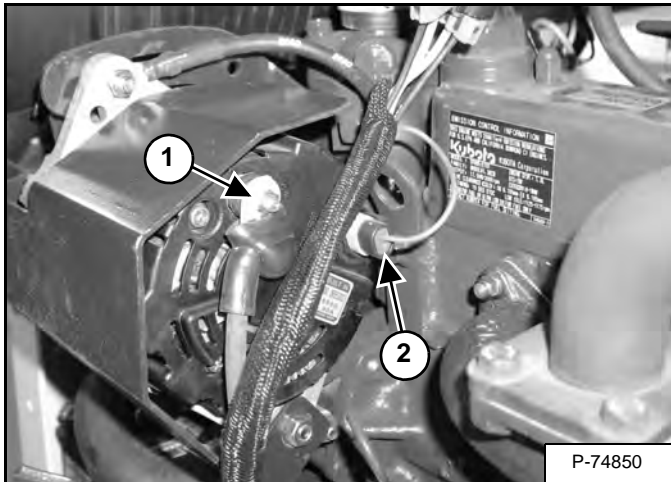

Open the rear door. Disconnect the negative (-) battery cable.

Move the protective cover and disconnect the red wire (Item 1) [Figure 60-30-6] from the alternator.

Disconnect the wiring harness connector (Item 2) [Figure 60-30-6] from the alternator.

Figure 60-30-7

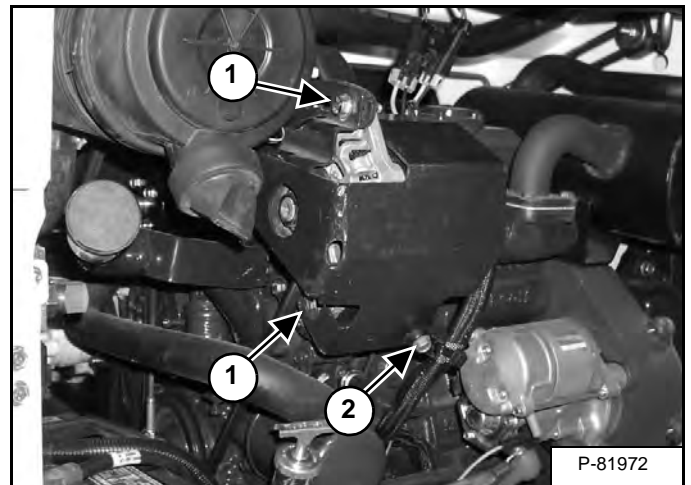

Remove the bolts (Item 1) and harness retaining bolt (Item 2) [Figure 60-30-7] to remove the alternator shield and the alternator.

Figure 60-30-8

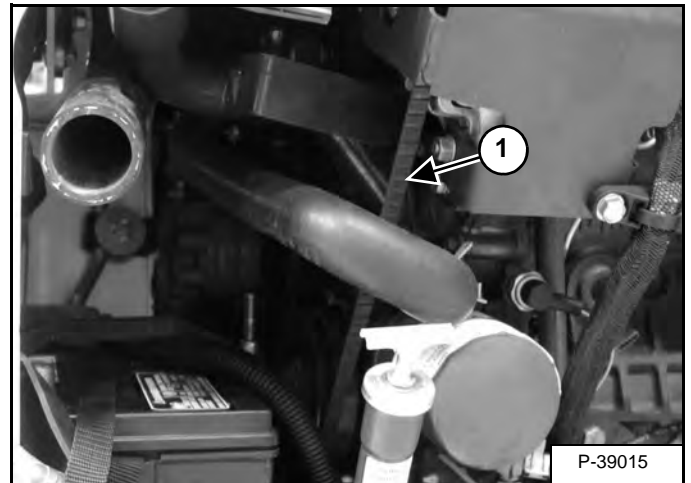

Loosen the adjustment bolts and move the alternator so there is 6 mm (1/4 in) belt movement at mid span when 67 N (15 lb) of force is applied to the belt (Item 1) [Figure 60-30-8].

Tighten the adjustment and mounting bolts.

ALTERNATOR (CONT'D)

Parts Identification

- | | |
|-------------------|-----------|
| 1. STATOR ASSY | 7. O-RING |
| 2. HOUSING FRONT | 8. HEAD |
| 3. ROTOR ASSY | 9. SEAL |
| 4. RECTIFIER ASSY | 10. SEAL |
| 5. COVER | 11. SHAFT |
| 6. BOLT | 12. PLUG |

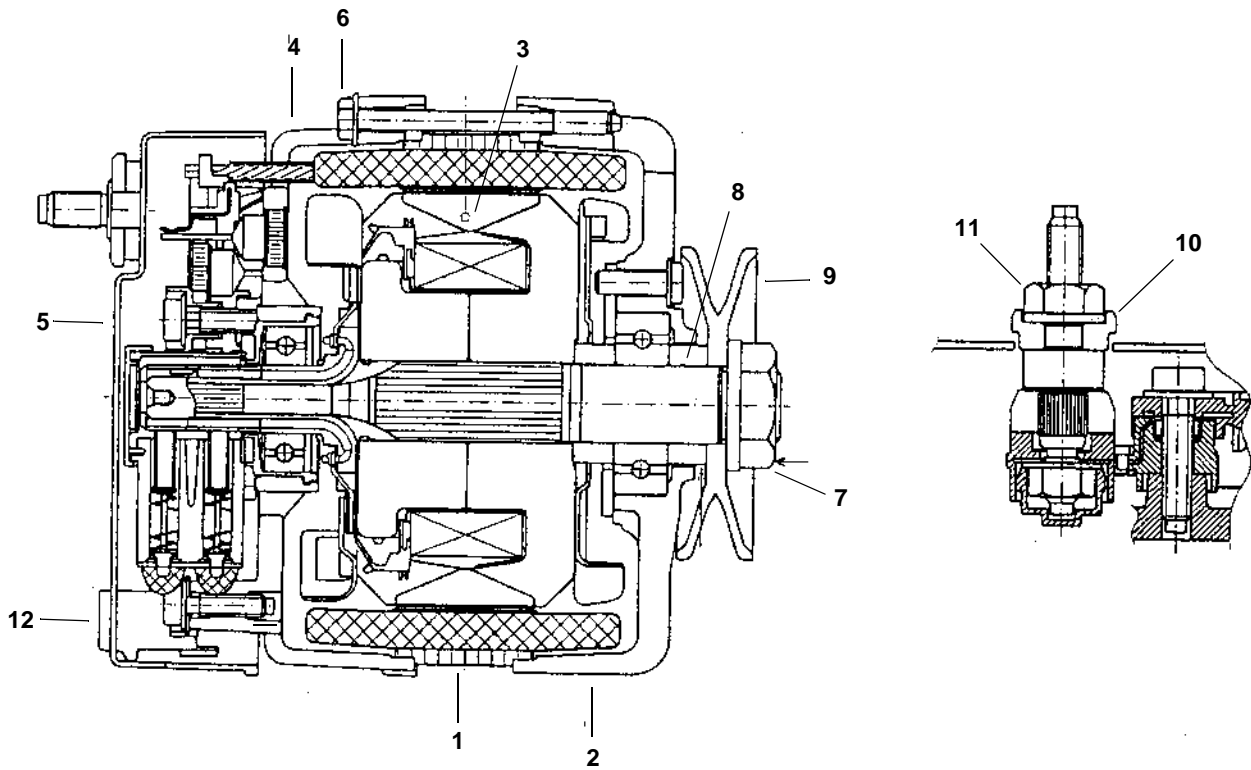

B20884

STARTER

Testing

Figure 60-40-1

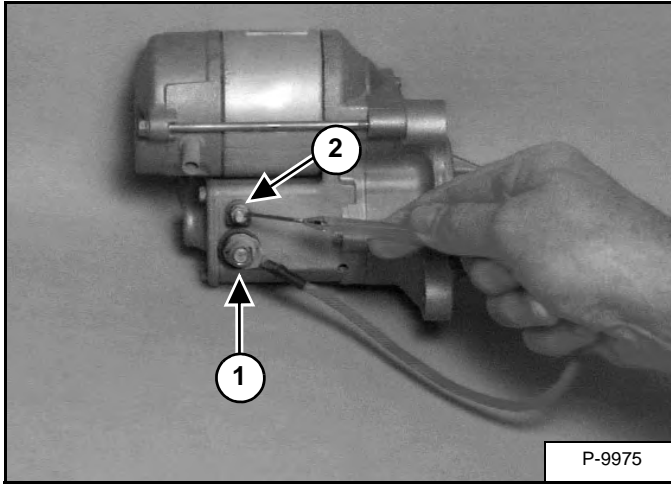

NOTE: The starter is removed from the loader for clarity.

The key switch must be in the OFF position.

The battery must be at full charge.

The cable connections on the battery must be clean and tight.

Connect a jumper wire between battery terminal (Item 1) and the solenoid terminal (Item 2) [Figure 60-40-1].

If the starter turns but does not turn the engine, the starter drive has a defect.

Figure 60-40-2

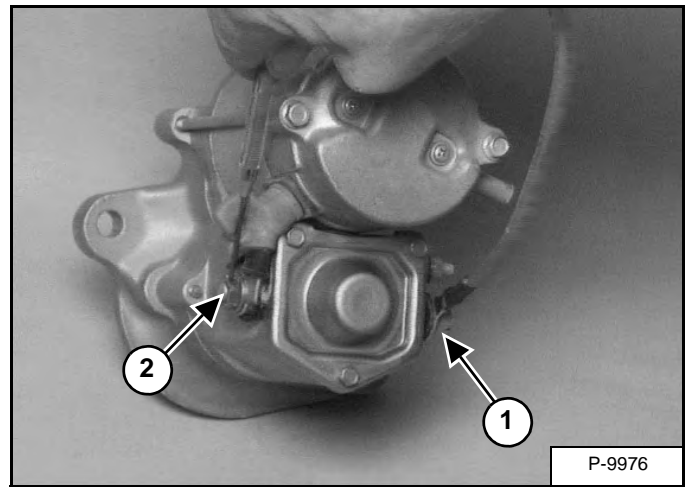

Connect a jumper wire between the battery terminal (Item 1) and the motor terminal (Item 2) [Figure 60-40-2].

If the starter turns, the defect is in the solenoid.

If the starter does not turn, the starter is defective.

STARTER (CONT'D)

Testing (Cont'd)

Figure 60-40-3

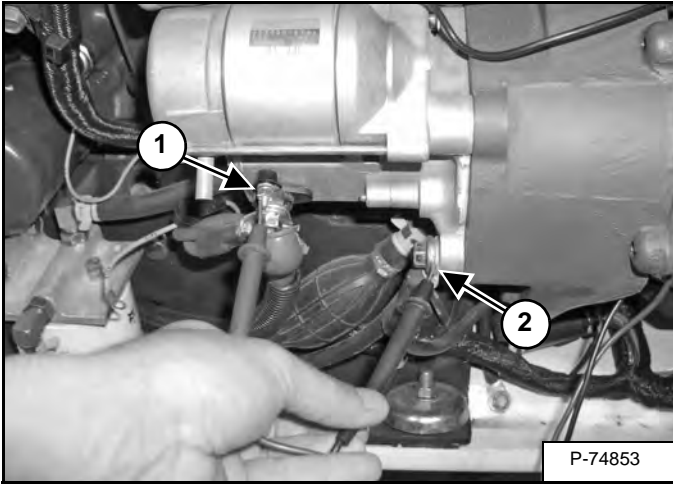

Disconnect the negative cable from the battery. (See Removal And Installation on Page 60-20-1.)

Disconnect the S-terminal on the starter (Item 1) [Figure 60-40-3].

Hold-In Test: Use circuit tester, attach one probe to the S-terminal (Item 1) and one probe to the mounting bolt (Item 2) [Figure 60-40-3] on the magnetic switch (solenoid). If there is no continuity replace the magnetic switch (solenoid).

Figure 60-40-4

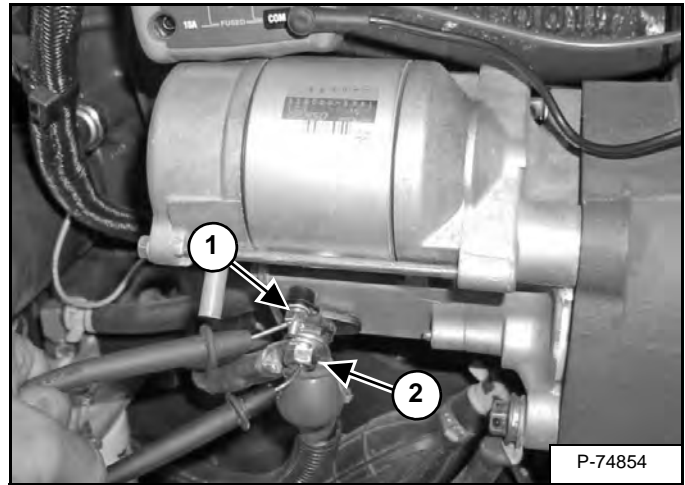

Disconnect the negative cable from the battery. (See Removal And Installation on Page 60-20-1.)

Disconnect the S-terminal on the starter (Item 1) [Figure 60-40-4].

Pull-In Test: Use circuit tester, touch one probe to the S-terminal (Item 1) and one probe to the starter motor terminal (Item 2) [Figure 60-40-4]. If there is no continuity replace the magnetic switch (solenoid).

STARTER (CONT'D)

Removal And Installation

Stop the engine and open the rear door.

Disconnect the negative (-) cable from the battery.

Installation: Make note of the wiring connections on the starter to ensure correct installation.

Figure 60-40-5

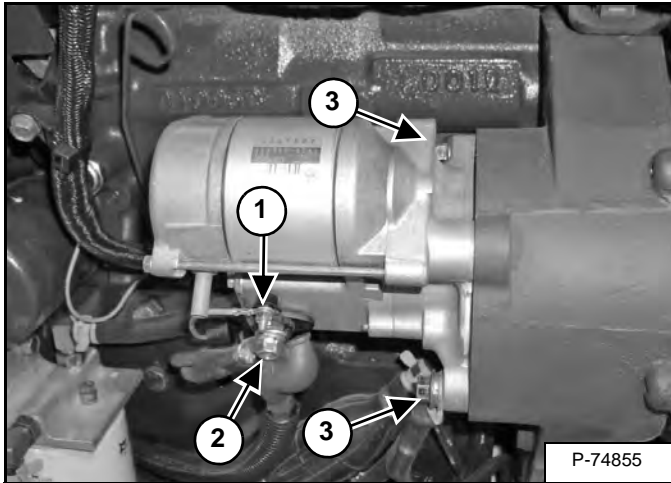

Remove the rubber cover from the solenoid terminal (Item 1) [Figure 60-40-5].

Remove the positive (+) wires (Item 2) [Figure 60-40-5] from the starter.

Remove the solenoid wire (Item 1) [Figure 60-40-5].

Remove the starter mounting bolt (Item 3) [Figure 60-40-5] and negative (-) cables.

Remove the starter.

Installation: Tighten the starter mounting bolts to 34 - 38 N•m (25 - 28 ft-lb) torque.

STARTER (CONT'D)

Parts Identification

- 1. Bearing
- 2. Armature
- 3. Bearing
- 4. Frame
- 5. Brush Spring
- 6. Brush Holder
- 7. Cover
- 8. Bolt
- 9. Cover
- 10. Gasket
- 11. Switch
- 12. Clutch
- 13. Pinion Shaft
- 14. Nut
- 15. Washer
- 16. Roller
- 17. Retainer
- 18. Idler Gear
- 19. Ball
- 20. Spring
- 21. Housing
- 22. Screw
- 23. O-ring
- 24. Snap Ring
- 25. Collar
- 26. Pinion Gear
- 27. Spring Seat
- 28. Spring

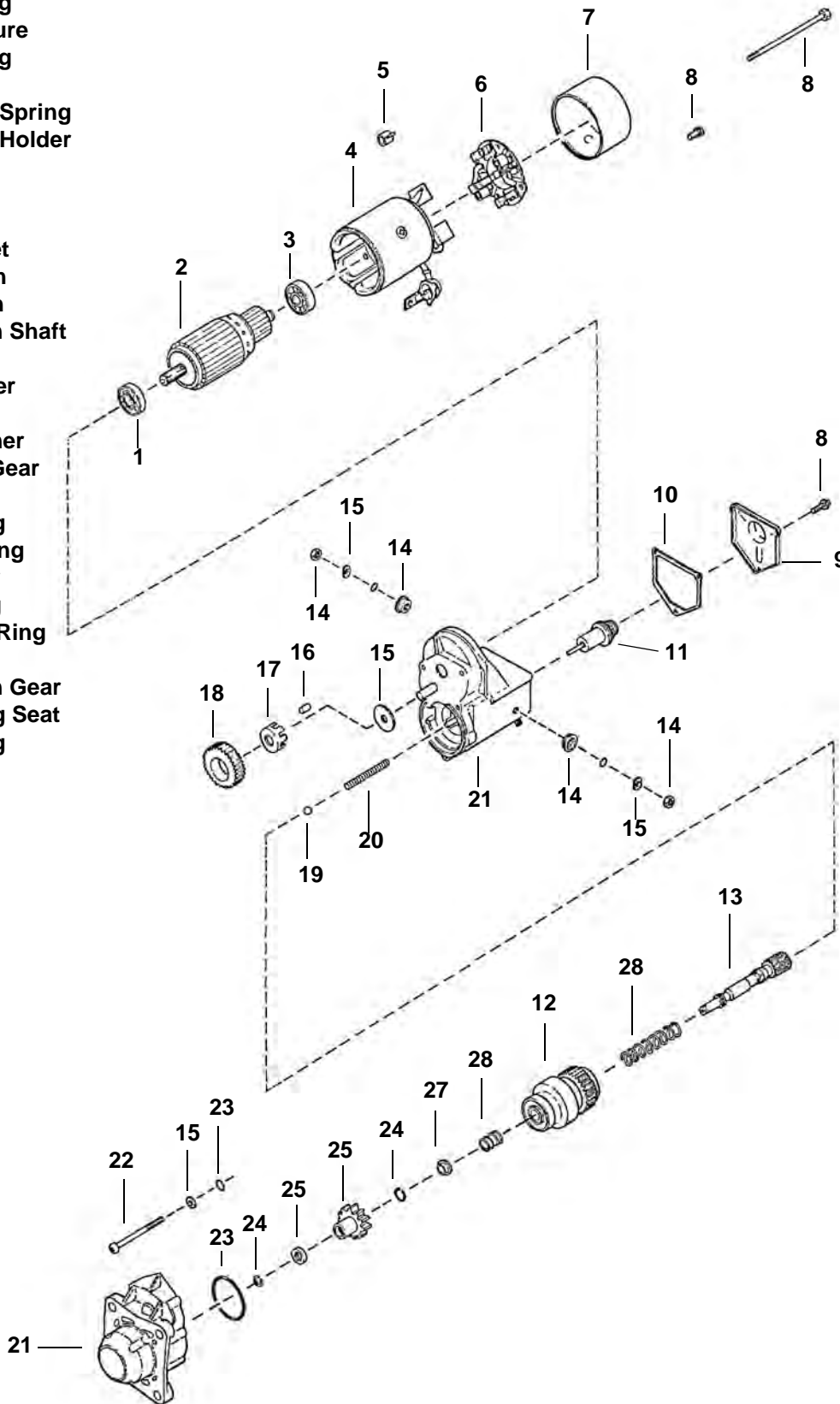

D-2297

INSTRUMENT PANELS

Left And Right Panels

Figure 60-50-1

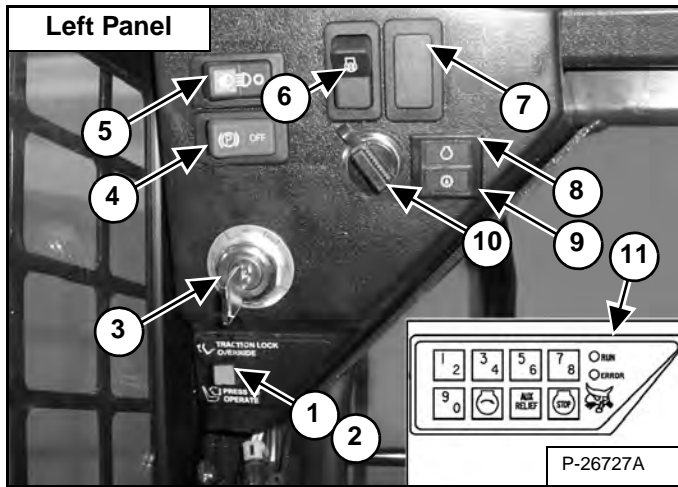
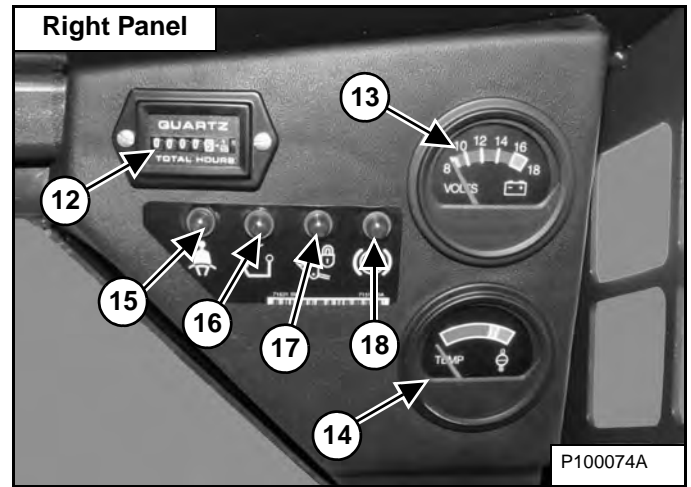

Figure 60-50-2



The table below shows the DESCRIPTION and FUNCTION / OPERATION for each of the instrument panel components.

REF.	DESCRIPTION	FUNCTION / OPERATION
1	TRACTION LOCK OVERRIDE BUTTON	<i>(Functions Only When The Seat Bar Is Raised, the Parking Brake Switch is OFF and the Engine Is Running.)</i> Allows you to use the steering levers to move the loader forward or backward when using the backhoe attachment. (See TRACTION LOCK OVERRIDE in this manual.) Engages auxiliary hydraulics.
2	PRESS TO OPERATE LOADER BUTTON	<i>(Functions Only When The Seat Bar Is Down.)</i> Activates BICS™ when the Seat Bar is down and operator is seated in the operating position. Engages auxiliary hydraulics.
3	KEY SWITCH	For starting and stopping the engine. (See Standard Key Panel in this manual.)
4	PARKING BRAKE	Press the left side of switch to engage; press right side to disengage.
5	LIGHT SWITCH	For FRONT work lights, “red” rear light, and REAR work light: Press the switch fully to the right to turn all lights OFF. Press the switch to the center position to turn on the FRONT work lights and “red” rear light. Press the switch fully to the left to turn on the FRONT work lights and REAR work light.
6	PREHEAT SWITCH	Press and hold to preheat the glow plugs to aid in cold temperature starting. (Earlier Models)
7	NOT USED	- - -
8	ENGINE WARNING LIGHT	Light is ON when engine oil pressure is low or coolant temperature is high. Stop the engine if the light comes ON.
9	TRANSMISSION WARNING LIGHT	Light is ON when transmission charge pressure is low, hydraulic filter needs replacement or fluid temperature is high. Stop the engine if the light comes ON.
10	POWER PLUG	Used to power 12 volt accessories.
11	KEYLESS PANEL	Optional Keyless Panel Kit. (See Keyless Start Panel in this manual.)
12	HOURLMETER	Records the total operating hours of the loader.
13	VOLTMETER	Shows the condition of the battery and the rate of charge.
14	ENGINE TEMPERATURE GAUGE	Shows the engine coolant temperature.
15	SEAT BELT INDICATOR LIGHT	Light stays on for 45 seconds to remind operator to fasten seat belt.
16	SEAT BAR LIGHT	Light is ON when the seat bar is raised.
17	LIFT & TILT VALVE LIGHT	Light is ON when the lift and tilt functions can <u>NOT</u> be operated. Light is OFF when the seat bar is down, the key switch is in the ON position and the PRESS TO OPERATE LOADER Button is pressed. The lift and tilt functions <u>can</u> be operated when the light is OFF.
18	PARKING BRAKE LIGHT	Light is ON when the Parking Brake is engaged.

INSTRUMENT PANELS (CONT'D)

Standard Key Panel

Figure 60-50-3

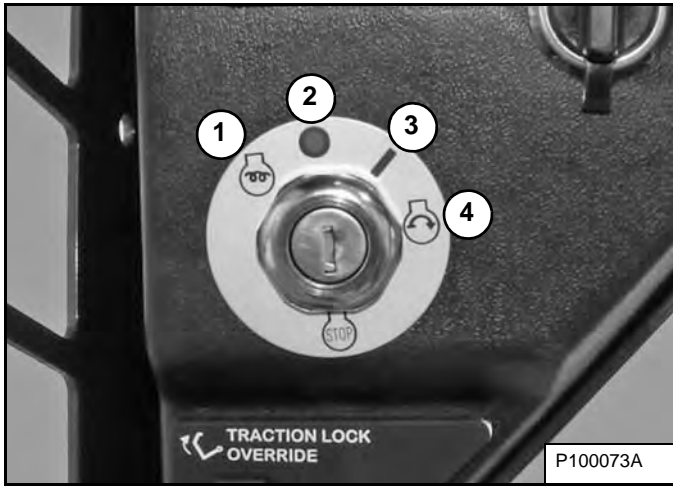

The functions of the Key Switch [Figure 60-50-3] are:

1. **ENGINE PREHEAT:** Hold the key in this position to activate the glow pugs. (Earlier model loaders have a separate preheat switch and do not have this position.) (See Left And Right Panels on Page 60-50-1.)
2. **STOP:** Stop the engine and turn the loader electrical system OFF.
3. **RUN:** Turn the loader electrical system ON.
4. **START:** Hold the key in this position to start the engine; release when engine starts.

Keyless Start Panel

Figure 60-50-4

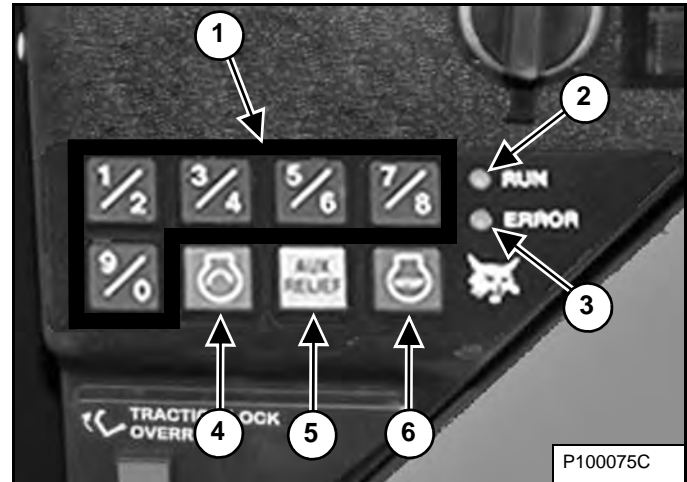

The functions of the Keyless Start Panel [Figure 60-50-4] are:

1. **KEYPAD (Keys 1 through 0):** Used to enter a number code (password) to allow starting the engine.
2. **RUN LIGHT:** Light will be ON after the password has been correctly entered.
3. **ERROR LIGHT:** Light will be ON when an incorrect user / master password is entered. Three consecutive incorrect passwords will cause an error condition and a delay of one minute will be required before another start sequence can be attempted.
4. **START Button:** Press the start button until the engine starts.
5. **AUX. RELIEF / PREHEAT Button:** Press and hold to activate the glow plugs after the password has been entered.
6. **STOP Button:** Used to stop the engine and shut down the loader electrical system.

NOTE: When a Keyless Start Panel Kit is installed, the kit will be supplied with an Owner Password. Change the password to one that you will easily remember to prevent unauthorized use of your loader. Keep your password in a safe place for future needs. (The instructions included with the Keyless Start Panel will describe how to change the password. Keep this instruction for future reference.)

INSTRUMENT PANELS (CONT'D)

Option And Field Accessory Panel

Figure 60-50-5

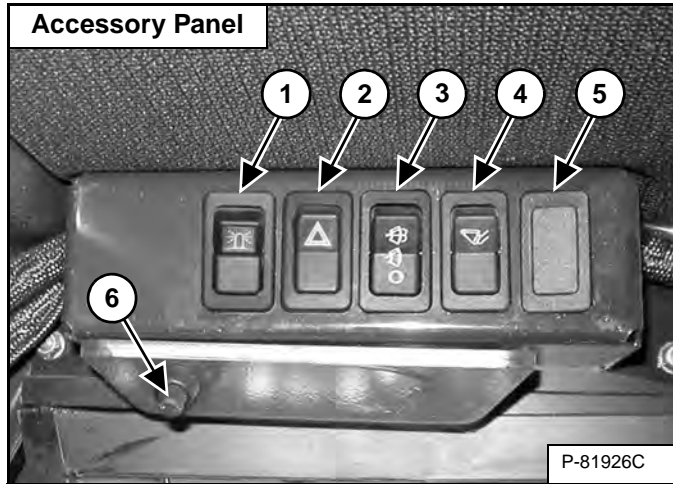

The side accessory panel is shown in [Figure 60-50-5].

REF. NO.	DESCRIPTION	FUNCTION / OPERATION
1	ROTATING BEACON (Option) OR STROBE LIGHT (Option)	Press the top of the switch to turn ON; press bottom to turn OFF.
2	HAZARD LIGHTS (Option)	Press the top of the switch to turn the Hazard Lights ON; press bottom to turn OFF.
3	FRONT WINDSHIELD WIPER (Option)	Move the switch to the center position to turn ON; press bottom to turn OFF. Press and hold the top of switch for washer fluid.
4	HYDRAULIC BUCKET POSITIONING (Option)	The Bucket Positioning function will keep the bucket in approximately the same position as the lift arms are raised. Press the top of the switch to engage the Bucket Position function; press the bottom to disengage.
5	NOT USED	- - -
6	CAB LIGHT (Option)	Press the switch to turn ON, press again to turn OFF.

INSTRUMENT PANELS (CONT'D)

Left And Right Removal And Installation

Figure 60-50-6

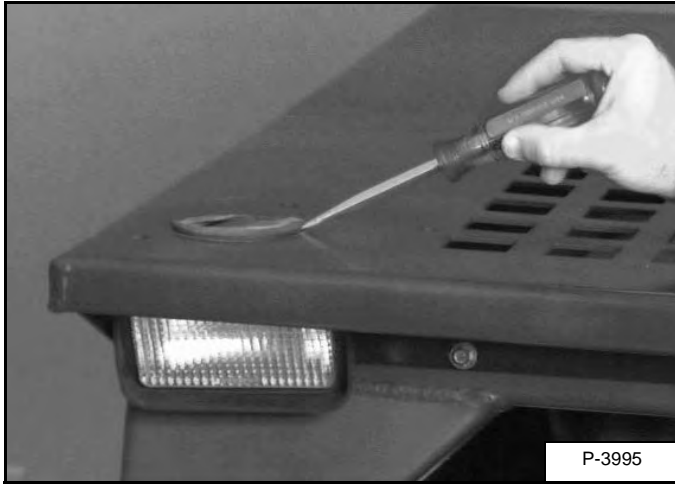

Pry the rubber light mount (optional) loose from the operator cab (both sides) [Figure 60-50-6].

Figure 60-50-7

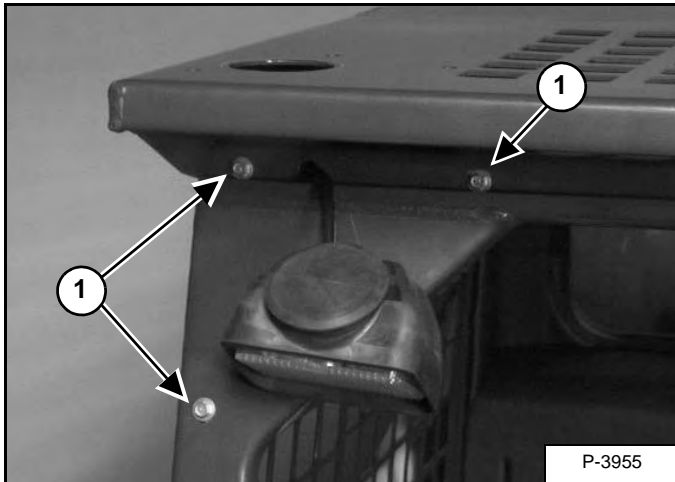

Lower the light (optional) from the operator cab and locate the three instrument panel mounting bolts (Item 1) [Figure 60-50-7] (both sides).

Remove the three mounting bolts (Item 1) [Figure 60-50-7].

Installation: Do not overtighten the instrument panel mounting bolts to prevent stripping of the threaded holes in panels.

Figure 60-50-8



Pull the right instrument panel down and disconnect the wire harness connectors from the panel. Remove the panel [Figure 60-50-8].

Figure 60-50-9



Repeat steps [Figure 60-50-6] and [Figure 60-50-7]. Pull the left instrument panel down and disconnect the wire harness connectors from the panel. Remove the panel [Figure 60-50-9].

Reverse the removal procedure to install the instrument panel.

LIGHTS

Front Removal And Installation

Figure 60-60-1



The front lights are mounted in the upper corners of the operator cab [Figure 60-60-1].

Figure 60-60-2



Pry the rubber light mount free from the operator cab [Figure 60-60-2].

Figure 60-60-3

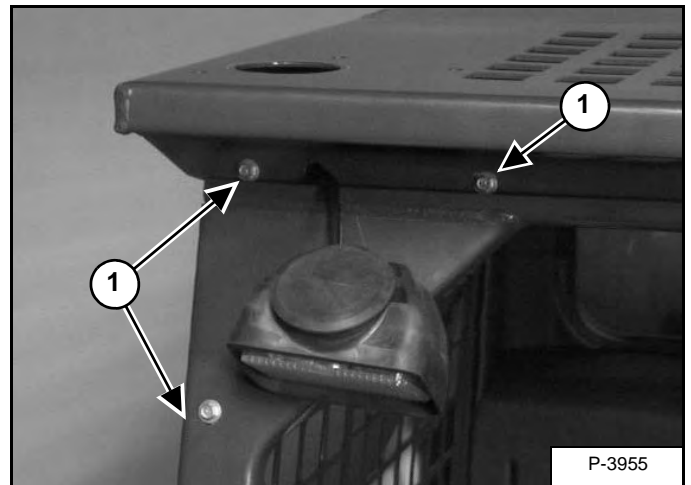

Pull the light down and remove the three mounting bolts (Item 1) [Figure 60-60-3] from the instrument panel.

Disconnect the front light connector from the instrument panel. Remove the front light from the operator cab.

Figure 60-60-4

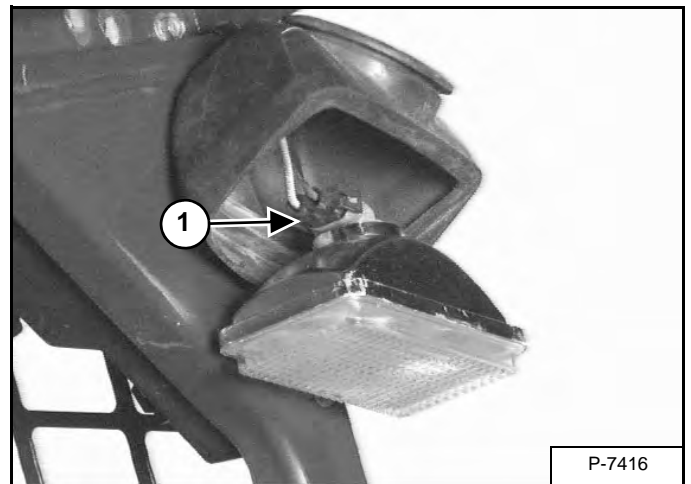

Disconnect the electrical connector (Item 1) [Figure 60-60-4] to remove the light from the rubber light mount.

LIGHTS (CONT'D)

Front Removal And Installation (Cont'd)

Figure 60-60-5

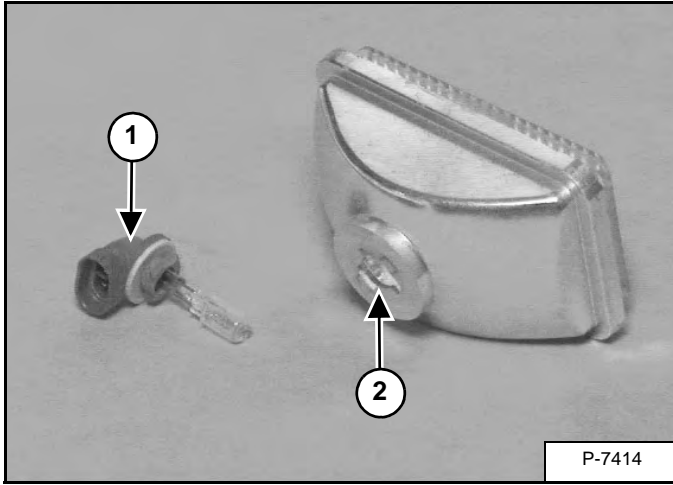

Turn the bulb (Item 1) and remove it from the cover (Item 2) [Figure 60-60-5].

Rear Removal And Installation

Figure 60-60-6

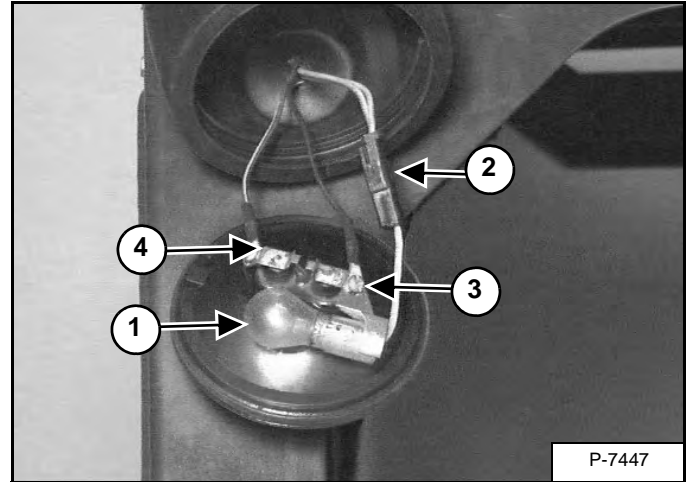

Remove the light from the rubber mount.

Push the work bulb (Item 1) [Figure 60-60-6] in and turn it counterclockwise to remove it from the socket.

Disconnect the electrical connector (Item 2) [Figure 60-60-6] from the cab harness.

Remove the screw (Item 3) [Figure 60-60-6] to remove the work light socket from the rear light.

Remove the screws (Items 3 and 4) [Figure 60-60-6] to remove the rear light.

LIGHTS (CONT'D)

Cab Light Removal And Installation (Earlier Models)

NOTE: To *replace* the original cab light on earlier models, see the Service Parts manual.

NOTE: To remove the cab light on later models, (See Cab Light Removal And Installation (Later Models) on Page 60-60-4.)

Figure 60-60-7

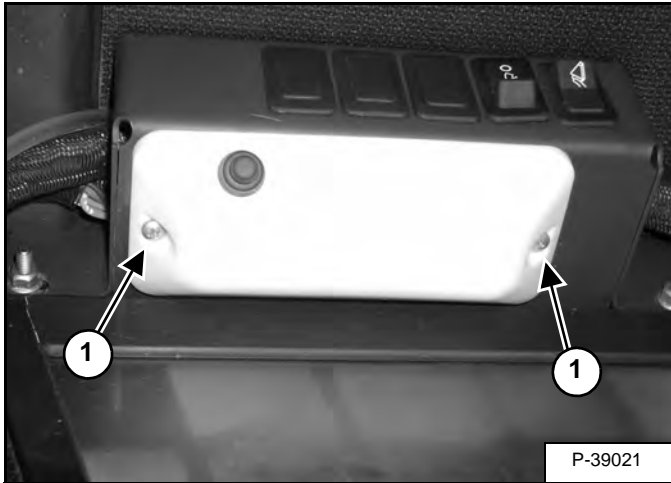

The cab light is mounted in the upper left rear corner of the operator cab. Remove the two mounting screws (Item 1) [Figure 60-60-7] to remove the light cover.

Figure 60-60-8

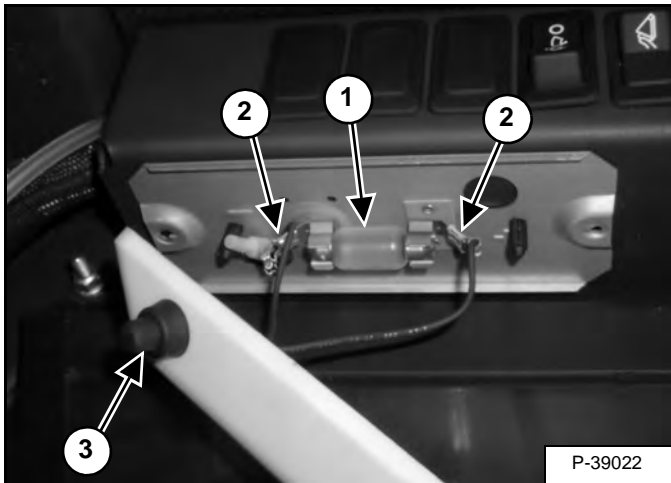

Lower the cover to access the light bulb (Item 1). The switch can be replaced by removing the wires from the terminals (Item 2) and unscrewing the switch (Item 3) [Figure 60-60-8] from the light cover.

Figure 60-60-9

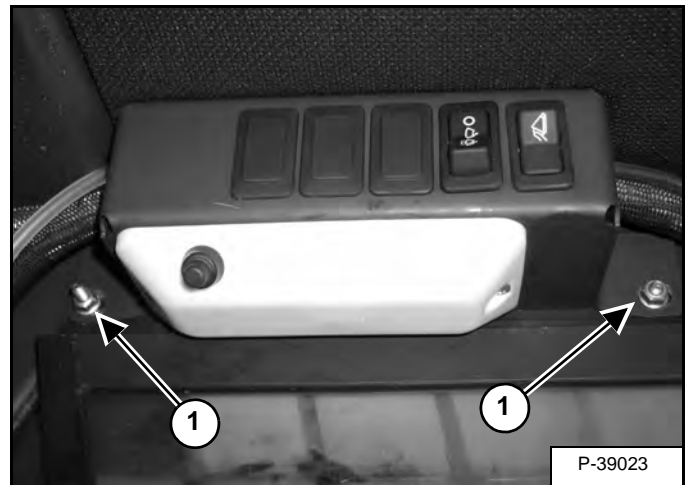

Remove the mounting bolts (Item 1) [Figure 60-60-9] to lower the instrument panel.

Figure 60-60-10

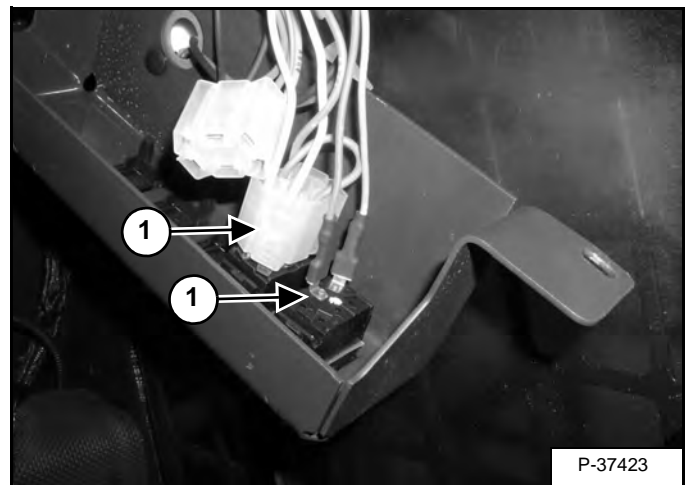

Disconnect the electrical connectors (Item 1) [Figure 60-60-10] from any switches in the light housing.

LIGHTS (CONT'D)

Cab Light Removal And Installation (Later Models)

Figure 60-60-11

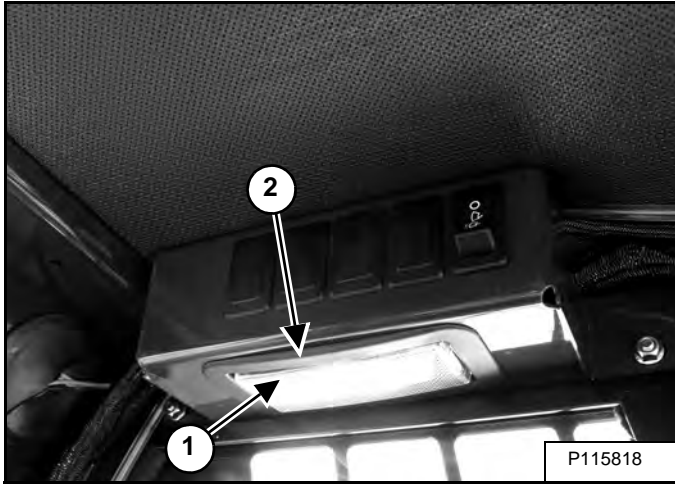

Pry the cab light lens (Item 1) from the housing (Item 2) [Figure 60-60-11].

Figure 60-60-12

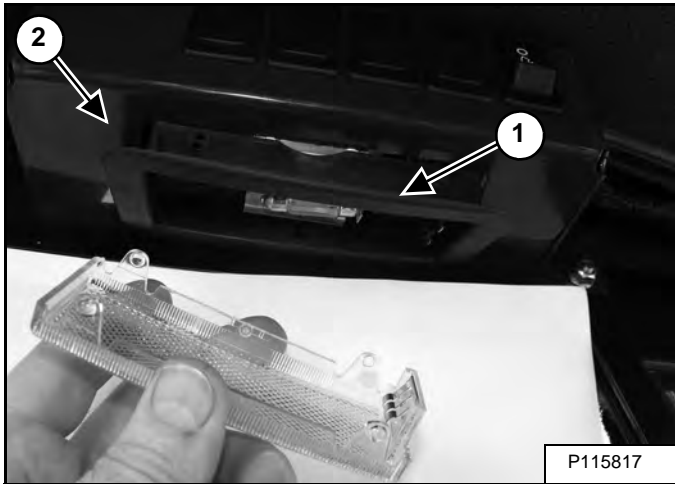

Pry the cab light housing (Item 1) [Figure 60-60-12] from the side panel (Item 2) [Figure 60-60-12].

NOTE: Replacement of the complete LED assembly is required for servicing.

Figure 60-60-13

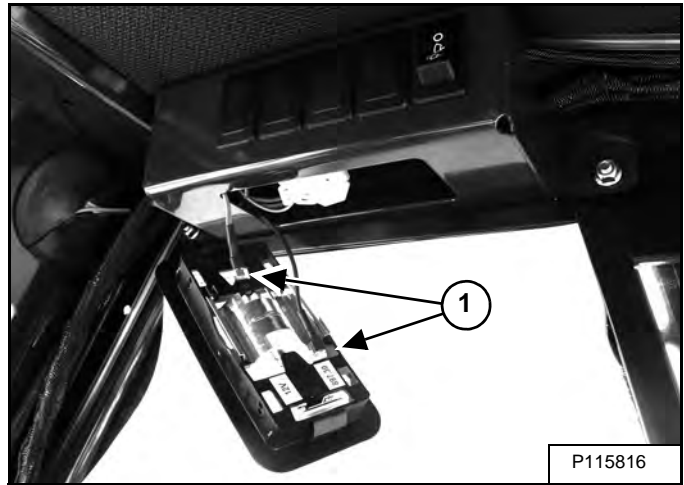

Disconnect the cab light wires (Item 1) [Figure 60-60-13] and remove the light.

NOTE: Do not pull the cab light too far away from the panel to prevent damage to the wires.

BOBCAT INTERLOCK CONTROL SYSTEM (BICS™)

Description

Figure 60-70-1

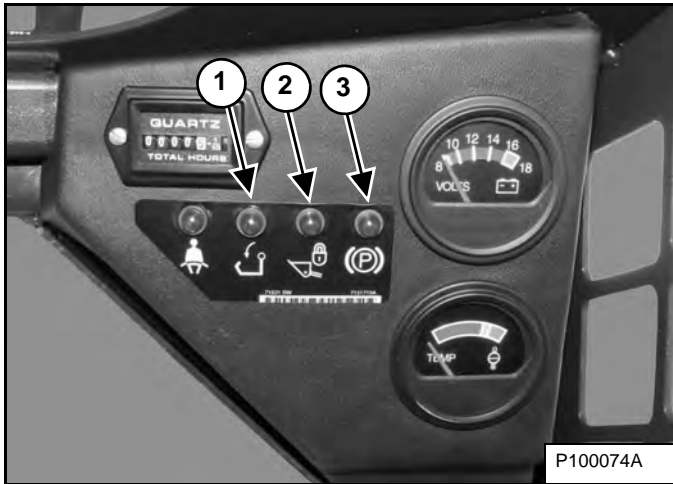

The Bobcat Interlock Control System has a pivoting seat bar with armrests that are used to protect the operator. The system consists of lift, tilt, auxiliary hydraulics and traction drive functions.

These all have display lights on the right instrument panel (Item 1, 2, and 3) **[Figure 60-70-1]** that must be OFF to fully operate the machine.

When the seat bar is lowered, the engine is running, the parking brake released, the PRESS TO OPERATE LOADER button is activated and allows the operator to function the loader. The seat belt must be fastened any time the loader is operated.

When the seat bar is raised the lift, tilt, auxiliary hydraulics and traction drive functions are deactivated.

BOBCAT INTERLOCK CONTROL SYSTEM (BICS™) (CONT'D)

Perform the procedures on flat level ground and make sure the area is clear of bystanders.

Inspecting The BICS™ Controller (Engine STOPPED - Key ON)

Figure 60-70-2

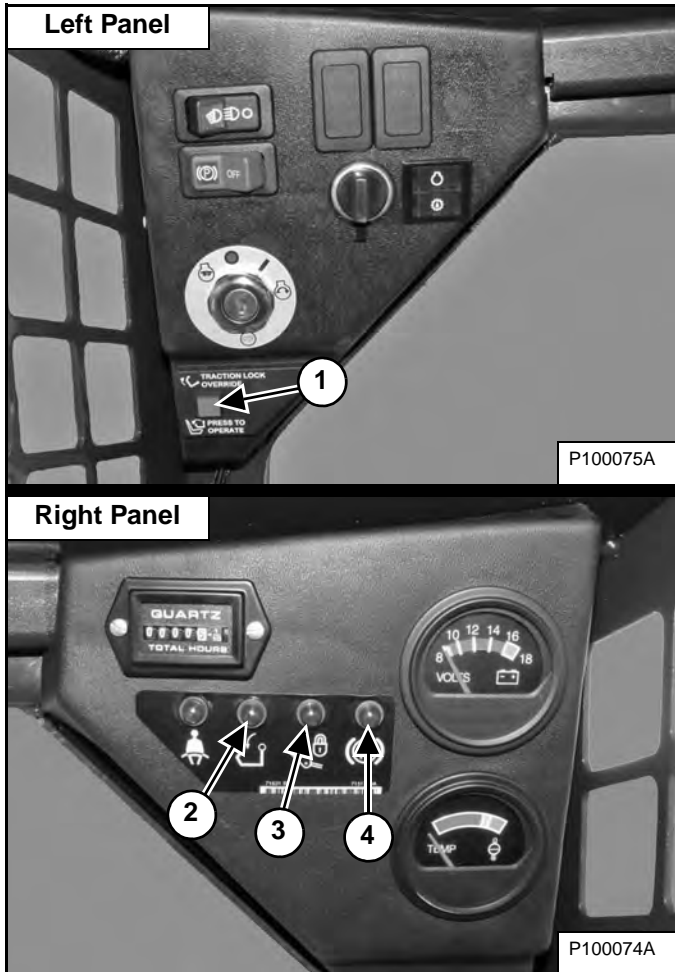

1. Sit in the operator's seat, fasten the seat belt, turn the key ON (Keyless Start Panel - enter the password / user code on the keypad), lower the seat bar and disengage the parking brake. Press the PRESS TO OPERATE LOADER button (Item 1). The three BICS™ lights (Items 2, 3 and 4) on the right instrument panel must be OFF (SEAT BAR, LIFT & TILT VALVE, and PARKING BRAKE) [Figure 60-70-2].
2. Raise the seat bar fully. The three BICS™ lights (Items 2, 3 and 4) [Figure 60-70-2] on the right instrument panel must be ON (SEAT BAR, LIFT & TILT VALVE, and PARKING BRAKE).

NOTE: Record what lights are blinking (if any) and the number of light flashes.

Inspecting The Seat Bar Sensor (Engine RUNNING)

3. Fasten the seat belt, lower the seat bar and make sure the parking brake is engaged.
4. Start the engine and operate at low idle. Press the PRESS TO OPERATE LOADER button. While raising the lift arms, raise the seat bar fully. The lift arms should stop. Repeat using the tilt function.

Inspecting The Traction Lock And Parking Brake (Engine RUNNING)

5. Fasten seat belt, lower the seat bar, disengage the parking brake and press the PRESS TO OPERATE LOADER button. Raise the seat bar fully and move the steering levers slowly forward and backward. The traction drive system will be locked.
6. Fasten seat belt, lower the seat bar and press the PRESS TO OPERATE LOADER button. Engage the parking brake and move the steering levers slowly forward and backward. The traction drive system will be locked.

NOTE: The PARKING BRAKE light on the left instrument panel will remain ON until the engine is started, the PRESS TO OPERATE LOADER button is pressed and the parking brake is disengaged.

Inspecting The Lift Arm Bypass Control

7. Raise the lift arms 2 m (6 ft) off the ground. Stop the engine. Turn the lift arm bypass control knob clockwise 1/4 turn. Pull out and hold the knob until the lift arms slowly lower.

! WARNING

AVOID INJURY OR DEATH

The Bobcat Interlock Control System (BICS™) must deactivate the lift, tilt, traction drive and front auxiliary hydraulic functions. If it does not, contact your dealer for service. **DO NOT** modify the system.

W-2689-0813

BOBCAT INTERLOCK CONTROL SYSTEM (BICS™) (CONT'D)

Inspecting Deactivation Of The Auxiliary Hydraulics System

Perform the procedures on flat level ground and make sure the area is clear of bystanders.

Figure 60-70-3

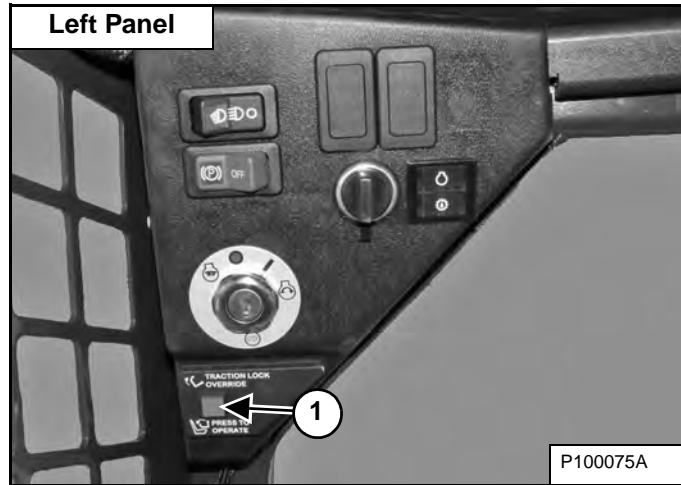

Engine Starting

8. Install an attachment with hydraulic connections. Perform the pre-starting procedure. Fasten the seat belt, lower the seat bar and make sure the parking brake is engaged. Start the engine. Move the Auxiliary Hydraulic Control Lever to the left or the right. There will not be hydraulic oil flow to the attachment.

Press the PRESS TO OPERATE LOADER button (Item 1) [Figure 60-70-3] and then engage the auxiliary hydraulics. The auxiliary hydraulic oil will flow to the attachment.

Engine Running

9. Install an attachment with hydraulic connections. Perform the pre-starting procedure. Fasten the seat belt, lower the seat bar and make sure the parking brake is engaged. Start the engine. Press the PRESS TO OPERATE LOADER button (Item 1) [Figure 60-70-3]. Move the Auxiliary Hydraulic Control Lever to the left or the right. The auxiliary hydraulic oil will flow to the attachment. Raise the seat bar. The auxiliary hydraulic oil flow to the attachment will STOP.

! WARNING

AVOID INJURY OR DEATH

The Bobcat Interlock Control System (BICS™) must deactivate the lift, tilt, traction drive and front auxiliary hydraulic functions. If it does not, contact your dealer for service. **DO NOT** modify the system.

W-2689-0813



Bobcat®

BOBCAT CONTROLLER (GATEWAY)

Description

The BICS™ controller provides information to control functions of the loader. All loaders have a BICS™ controller. The BICS™ controller is located inside the cab on the left side next to the seat.

Troubleshooting

The following troubleshooting guide is provided for assistance in locating and correcting BICS™ system problems. It is recommended that these procedures be done by authorized Bobcat Service Personnel only.



Check for correct function after adjustments, repairs or service. Failure to make correct repairs or adjustments can cause injury or death.

W-2004-1285



PROBLEM	SOLUTION #
Power indicator light does not come ON.	1, 2, 3, 5
One of the indicator lights flashing.	4
Intermittent indicator lights.	5, 6, 7, 8
Key ON, Seat bar down, push the Press to Operate Button. The System Activated, Seat Bar, Valve And Traction indicator lights remain ON.	9

SOLUTION SUGGESTIONS	
1.	Check that ignition switch ON.
2.	Check BICS™ 25 amp. fuse (fuses).
3.	Check wiring and connections. Make sure the connector is securely connected to the controller. Pull on connector to check.
4.	Refer to BICS™ controller troubleshooting chart. (See Troubleshooting on Page 60-80-1.)
5.	Check wire connections to make sure connectors are locked into place.
6.	Check pins in connectors for pins pushed back or bent.
7.	Move the system wiring back and forth to try to find area that may be causing the intermittent connection.
8.	Use Sensor Tester MEL1428 to isolate problem between sensor and controller and wiring.
9.	Check the wiring connections. Remove the left instrument panel and check the Push to Operate Button with an ohmmeter at the two pin connector.

BOBCAT CONTROLLER (GATEWAY) (CONT'D)

Troubleshooting (Cont'd)

The following list shows the probable causes when the BICS™ system lights are off or flashing and the associated service codes.

INDICATOR LIGHT	LIGHT ON	LIGHT OFF	EFFECT ON OPERATION OF LOADER WHEN LIGHT IS ON
 ①	Seat Bar <u>is</u> up.	Seat Bar is down.	Lift and tilt functions will not operate.
 ②	Control valve <u>cannot</u> be used.	Control valve can be used.	Lift and tilt functions will not operate.
 ③	Loader cannot be moved forward and backward.	Loader <u>can</u> be moved forward and backward.	Loader cannot be moved forward and backward.

Viewing Diagnostic Service Codes

The Seat Bar Light (Item 1), Valve Light (Item 2) and Parking Brake Light (Item 3) will flash to indicate SERVICE CODES. These lights may flash while the engine is running or with the engine OFF and the key ON.

NOTE: Multiple SERVICE CODES and / or abnormal symptoms can be caused by a corroded or loose ground. Check grounds and both battery connections.

The list below contains SERVICE CODES. These codes help analyze monitored functions of your Bobcat loader. Some service procedures must be performed ONLY BY QUALIFIED BOBCAT SERVICE PERSONNEL.

Indicator Light	LED	Function	Failure
1	Seat Bar - 2 Flashes	Seat Sensor	Out of Range Low
		8 Volt Sensor Supply	Out of Range Low
1	Seat Bar - 3 Flashes	Seat Sensor	Out of Range High
		8 Volt Sensor Supply	Out of Range High
2	Valve - 2 Flashes	Hydraulic Lock Valve Solenoid	Short to Battery
2	Valve - 3 Flashes	Hydraulic Lock Valve Solenoid	Short to Ground
2	Valve - 4 Flashes	Hydraulic Lock Valve Solenoid	Open Circuit
3	Parking Brake - 1 Flash	Traction Lock Hold Solenoid	Open Circuit
3	Parking Brake - 2 Flashes	Traction Lock Hold Solenoid	Short to Battery
3	Parking Brake - 3 Flashes	Traction Lock Hold Solenoid	Short to Ground
3	Parking Brake - 4 Flashes	Traction Lock Pull Output	Open Circuit
3	Parking Brake - 5 Flashes	Traction Lock Pull Output	Error On
		Traction Pull Relay	Error On
3	Parking Brake - 6 Flashes	Traction Lock Pull Output	Error Off
		Traction Pull Relay	Error Off

BOBCAT CONTROLLER (GATEWAY) (CONT'D)

Removal And Installation

Raise the operator cab. (See Raising on Page 10-30-2.)

Figure 60-80-1

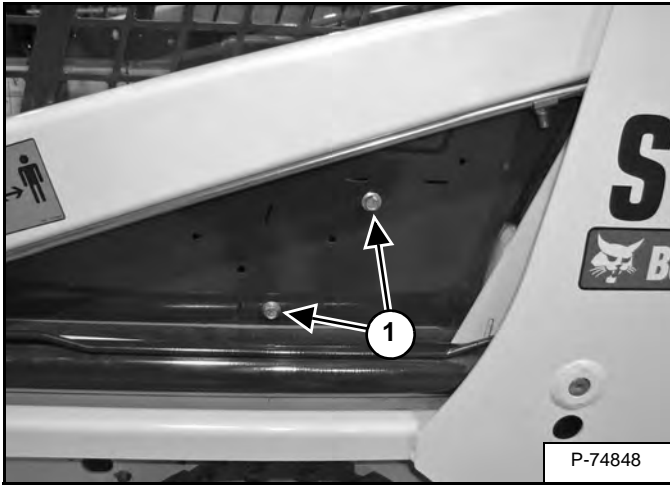

The controller mounting bolts are located on the left side of the operator cab.

Remove the mounting bolts (Item 1) [Figure 60-80-1] from the controller.

Installation: Tighten the controller mounting bolts 9 - 10 N•m (80 - 90 in-lb) torque.

Figure 60-80-2

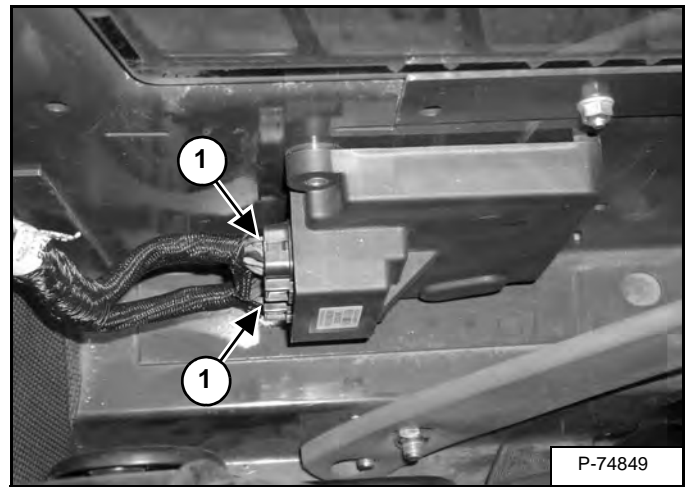

Disconnect the electrical harness connectors (Item 1) [Figure 60-80-2] from the controller and remove the controller from the loader.

Reverse the procedure to install the controller.



Bobcat®

SEAT BAR SENSOR

Description

The seat bar sensor is part of the BICS™ system. The seat bar sensor sends a signal that indicated whether the seat bar is in the down or up position.

The seat bar sensor is located at the left pivot point of the seat bar.

Troubleshooting

The following troubleshooting guide is provided for assistance in locating and correcting BICS™ system problems. It is recommended that these procedures be done by authorized Bobcat Service Personnel only.



Check for correct function after adjustments, repairs or service. Failure to make correct repairs or adjustments can cause injury or death.

W-2004-1285

PROBLEM	SOLUTION #
Indicator light does not go OFF when seat bar is lowered.	1, 2, 3, 4, 5, 6

SOLUTION SUGGESTIONS		
1.		Check controller power indicator light. It must be ON.
2.		Check sensor wire connection.
3.		Use the BICS™ Sensor Tester MEL1428 to check sensor and controller.
4.		Check for loose hardware.
5.		Check keyed bushing to make sure magnet collar rotates with seat bar.
6.		Check Magnet collar magnets for contamination such as metal particles.

SEAT BAR SENSOR (CONT'D)

Testing

Use Sensor Tester (MEL1428) for the following procedure:

Disconnect the short adapter test leads if connected.

Figure 60-90-1

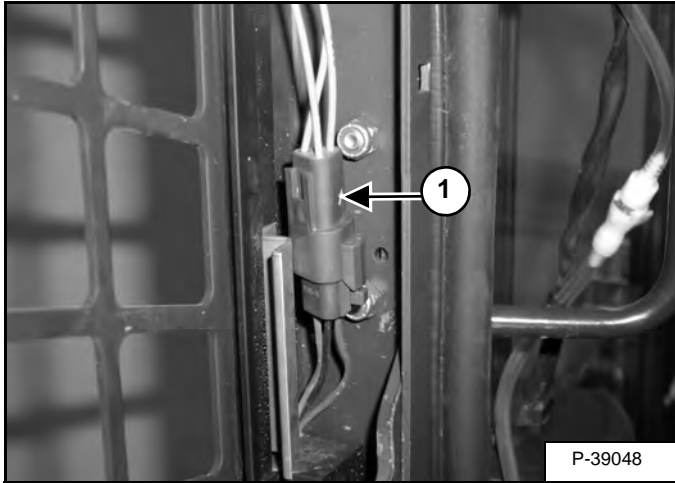

Disconnect the seat bar sensor connector (Item 1) [Figure 60-90-1].

Figure 60-90-2

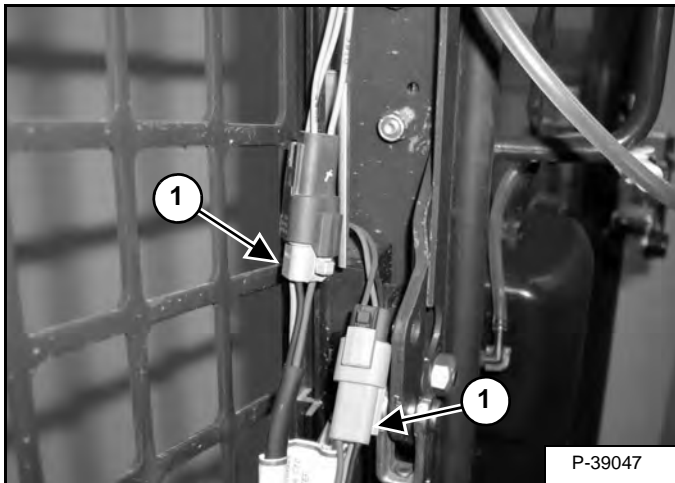

Connect Sensor Tester (Item 1) [Figure 60-90-2] in line as shown to the seat bar sensor connectors.

Turn the key to the ON position. **DO NOT START THE ENGINE.**

Figure 60-90-3

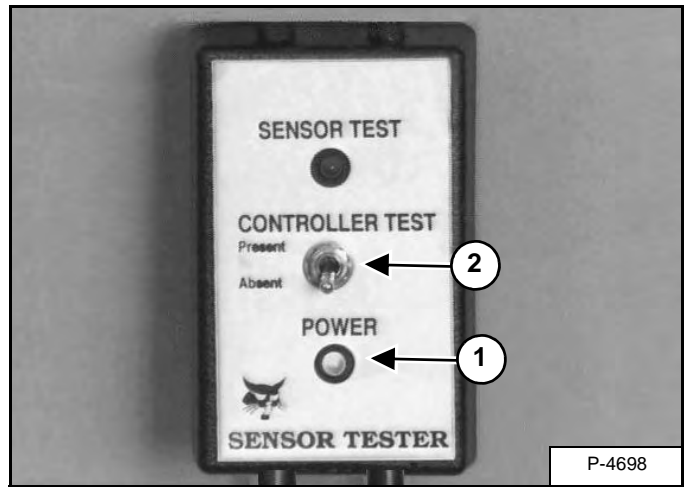

The toggle switch (Item 2) [Figure 60-90-3] can be in either the **Absent** or **Present** position.

The power light (Item 1) [Figure 60-90-3] will illuminate, if the light is not on, check the tester or wiring harness.

Figure 60-90-4

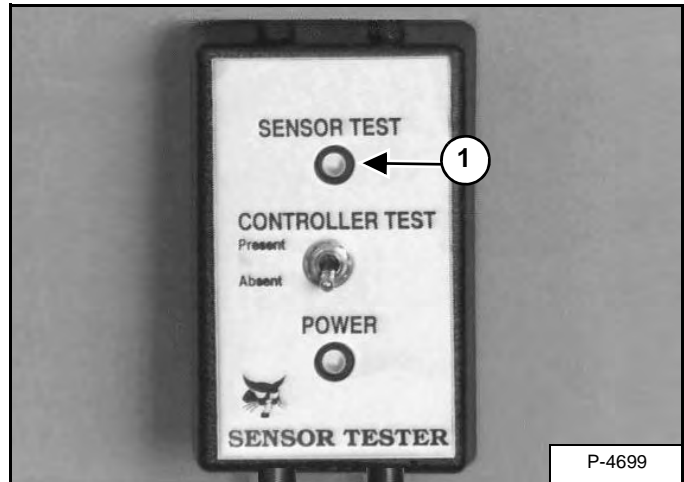

Lower the seat bar. The Sensor Test light (Item 1) [Figure 60-90-4] should illuminate.

Raise the seat bar. The Sensor Test light (Item 1) [Figure 60-90-4] should go off.

If the above tests fail, there is a problem with the seat bar sensor.

Disconnect the Sensor Tester.

Replace the Seat Bar Sensor. (See Removal And Installation on Page 60-90-3.)

If the above tests pass, run BICS™ controller seat bar circuit test. (See Bobcat Interlock Control System (BICS™) Circuit Test on Page 60-90-5.)

SEAT BAR SENSOR (CONT'D)

Removal And Installation

Figure 60-90-5

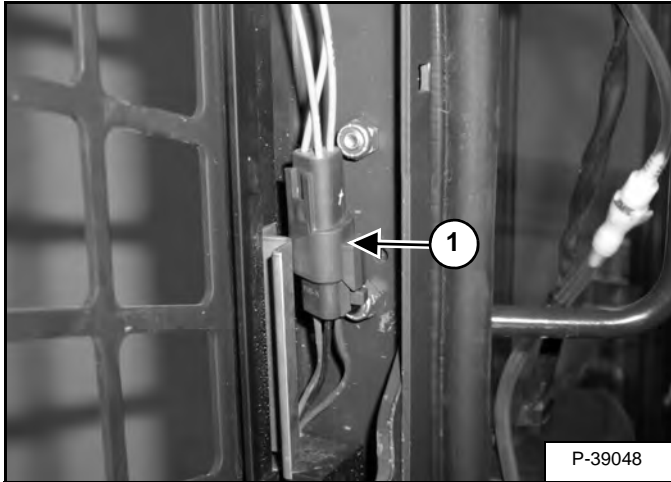

Disconnect the seat bar sensor connector (Item 1) [Figure 60-90-5].

Figure 60-90-6

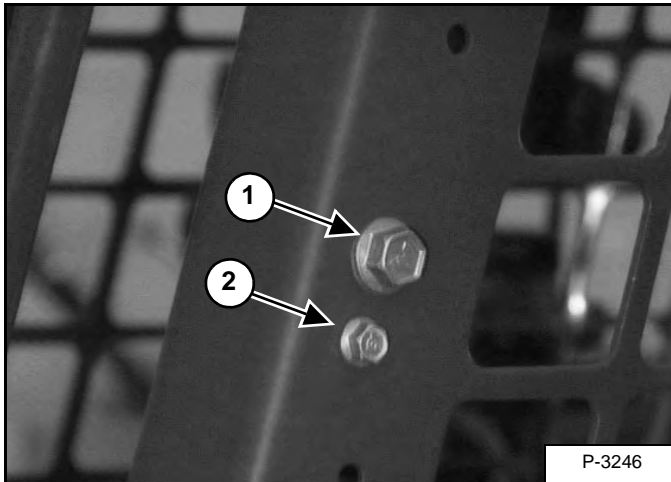

Remove the mounting bolt (Item 1) [Figure 60-90-6] from the pivot bushing.

Installation: Tighten the mounting bolt to 34 - 38 N•m (25 - 28 ft-lb) torque.

Remove the sensor mounting bolt (Item 2) [Figure 60-90-6] and nut.

IMPORTANT

Be careful to not overtighten the sensor mounting bolt and nut to prevent breakage of the sensor.

I-2088-1095

Figure 60-90-7

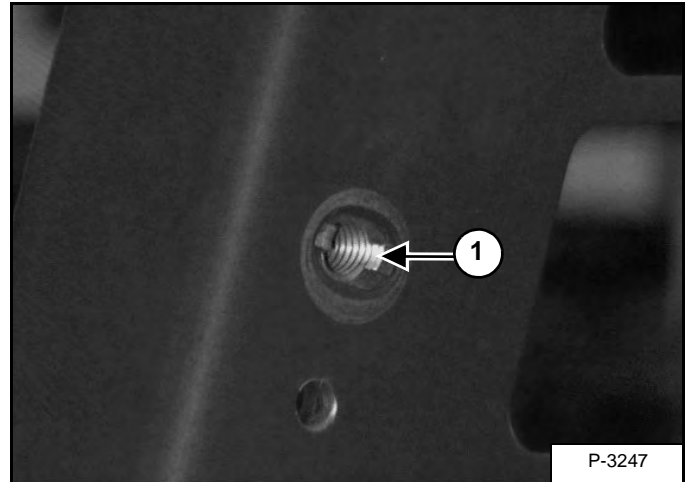

Installation: Be sure the tabs on the pivot bushing are positioned in the slotted hole (Item 1) [Figure 60-90-7] of the operator cab as shown.

SEAT BAR SENSOR (CONT'D)

Removal And Installation (Cont'd)

Pull the seat back and remove the assembly as follows:

Figure 60-90-8

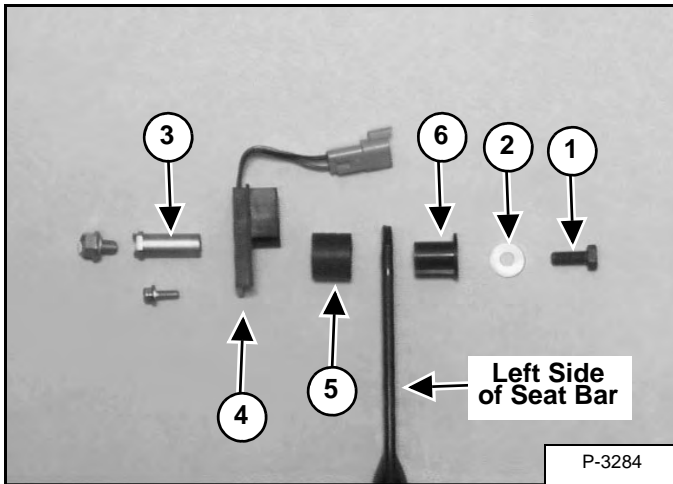

NOTE: The sensor assembly [Figure 60-90-8] is shown removed from the operator cab for clarity purpose only. The sensor assembly can be removed without removing the seat bar from the operator cab.

Remove the pivot bushing mounting bolt (Item 1) and the washer (Item 2) from the pivot bushing (Item 3) [Figure 60-90-8].

Installation: Tighten the pivot bushing mounting bolt to 21 - 23 N•m (180 - 200 in-lb) torque.

Remove the pivot bushing (Item 3), sensor (Item 4), magnet (Item 5) and plastic bushing (Item 6) [Figure 60-90-8] from the seat bar.

Inspect all parts for damage and wear and replace if necessary.

Reverse the removal procedure to install the seat bar sensor.

SEAT BAR SENSOR (CONT'D)

Bobcat Interlock Control System (BICS™) Circuit Test

Use Sensor Tester (MEL1428) For the following procedure:

Disconnect the short adapter test leads if connected.

Figure 60-90-9

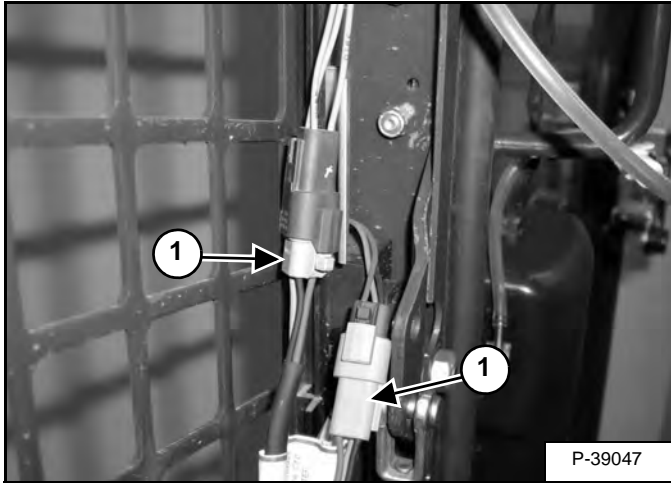
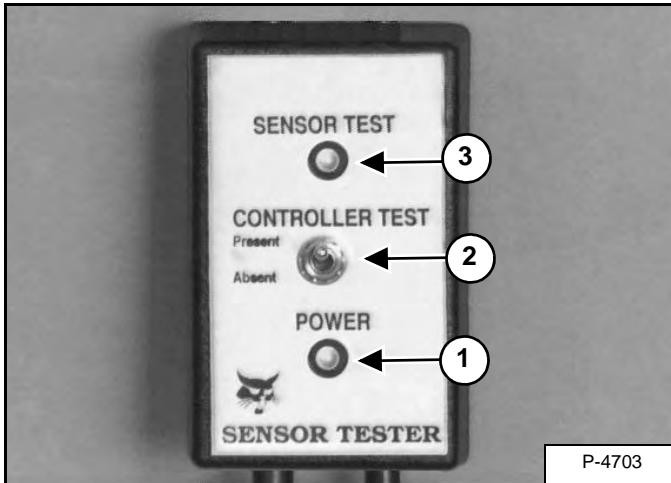

Figure 60-90-10



Disconnect the seat bar sensor connector and connect the Sensor Tester (Item 1) [Figure 60-90-9] inline as shown to the seat bar sensor connectors.

Turn the key to the ON position. **DO NOT START THE ENGINE.**

If there is no power light (Item 1) [Figure 60-90-10] on the Sensor Tester, check the testor or wiring harness.

Power light illuminated, move the toggle switch (Item 2) on the Sensor Tester (Item 1) [Figure 60-90-10] to the **Present** position.

NOTE: The sensor test light (Item 3) [Figure 60-90-10] is activated by the seat bar. It will be off with the seat bar up or on with the seat bar down.

Figure 60-90-11

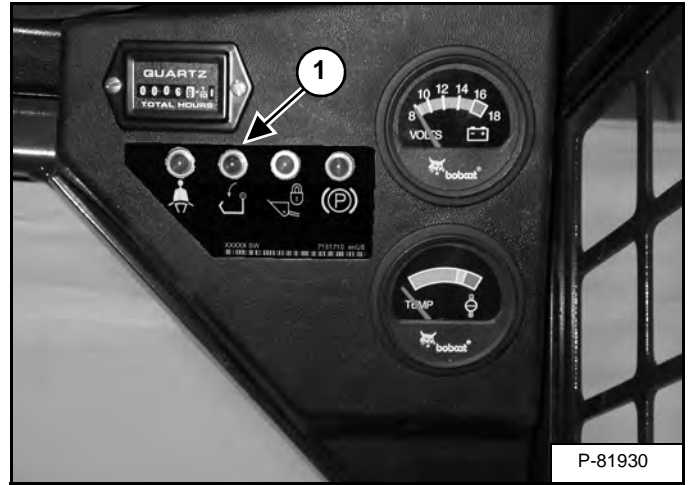

The seat bar light (Item 1) [Figure 60-90-11] on the right instrument panel should illuminate.

Figure 60-90-12

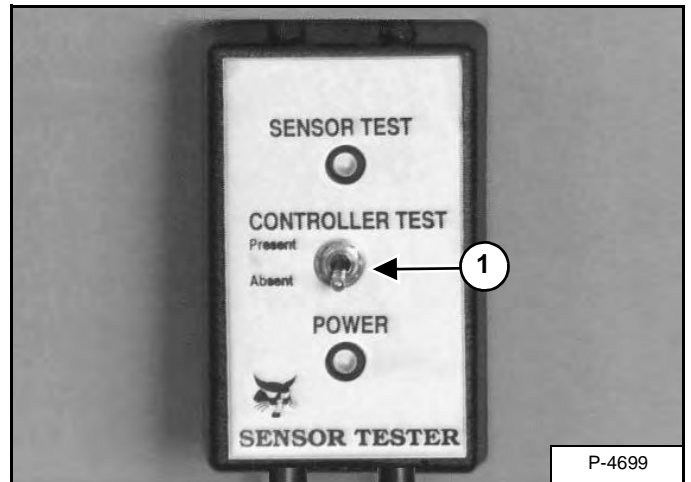

Move the toggle switch (Item 1) [Figure 60-90-12] on the Sensor Tester to the **Absent** position.

The seat bar light (Item 1) [Figure 60-90-11] should go off.

If the tests above fail, there is a problem with the BICS™ system controller or the wiring harness



Bobcat®

TRACTION LOCK

Description

The Traction Lock is controlled by the PRESS TO OPERATE button on the left instrument panel. The button controls the traction lock solenoid and wedge located on the rear cover of the chaincase.

In addition to the PRESS TO OPERATE button, the seat bar must be lowered for the loader to function.

Troubleshooting

The following troubleshooting guide is provided for assistance in locating and correcting BICS™ system problems. It is recommended that these procedures be done by authorized Bobcat Service Personnel only.



WARNING

Check for correct function after adjustments, repairs or service. Failure to make correct repairs or adjustments can cause injury or death.

W-2004-1285

PROBLEM	SOLUTION #
Traction lock stays engaged.	1, 2, 3, 4, 5, 6, 7
Intermittent activation of traction lock.	8, 9, 10

SOLUTION SUGGESTIONS
1. Check that controller power indicator light is ON.
2. Maneuver loader to allow brake discs to move and remove pressure on the brake wedge so it can retract.
3. If all lights indicate the brake should be released, but it doesn't, check the brake 25 amp. fuse.
4. When checking fuse, also check other fuses. Check the fuse block for correct orientation and location of fuses. (See Fuse And Relay Location / Identification on Page 60-10-8.)
5. To test the solenoid, the pull coil should be 0.4 - 0.5 ohm and the hold coil 10.5 - 11.0 ohm.
6. Check the brake solenoid and cover mounting hardware for the correct torque.
7. Remove the brake cover and check wedges for binding in the wedge guides.
8. Check wire connections for loose connector body.
9. Check for loose or bent pins in connectors.
10. Check for loose spade connectors in fuse holder.

TRACTION LOCK (CONT'D)

Removal And Installation

! WARNING

AVOID INJURY OR DEATH

Do not modify the electrical wiring connected to the traction lock solenoid or any part of the traction lock system. The traction lock provides the locking function of the parking brake. Service work on the traction lock system should only be performed by a qualified technician. Use only genuine Bobcat Company parts if repair is necessary.

W-2165-0100

Put jackstands under the rear of the loader.

Raise the loader operator cab. (See Raising on Page 10-30-2.)

Remove the center shield. (See Control Shield And Steering Lever Panels Removal And Installation on Page 50-90-1.)

Figure 60-100-1

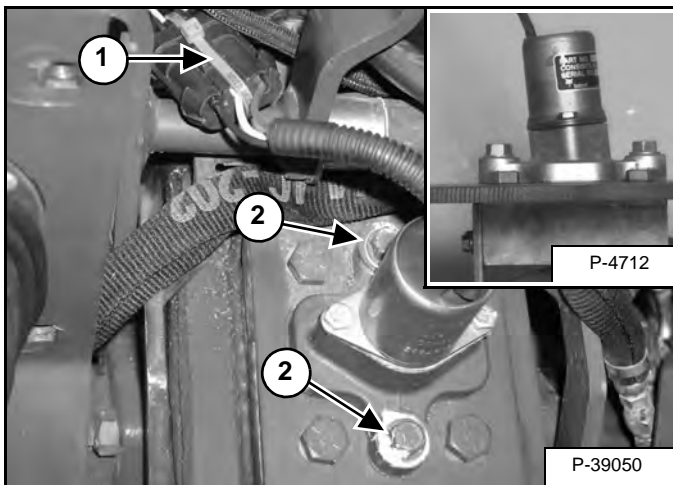

Remove the Do Not Modify sta-strap (P/N 6665527) from the electric solenoid connector (Item 1) [Figure 60-100-1].

Installation: Install a new Do Not Modify sta-strap (P/N 6665527) in the electric solenoid connector.

Remove the two mounting bolts (Item 2) [Figure 60-100-1] from the electric solenoid mounting bracket.

Installation: Tighten the mounting bolts 34 - 38 N•m (25 - 28 ft-lb) torque. Be sure the solenoid mounting bracket is installed in the same position. The solenoid mounting surface has a slight angle which tips the top of the solenoid toward the rear of the loader when installed correctly. (See inset photo [Figure 60-100-1].)

Figure 60-100-2

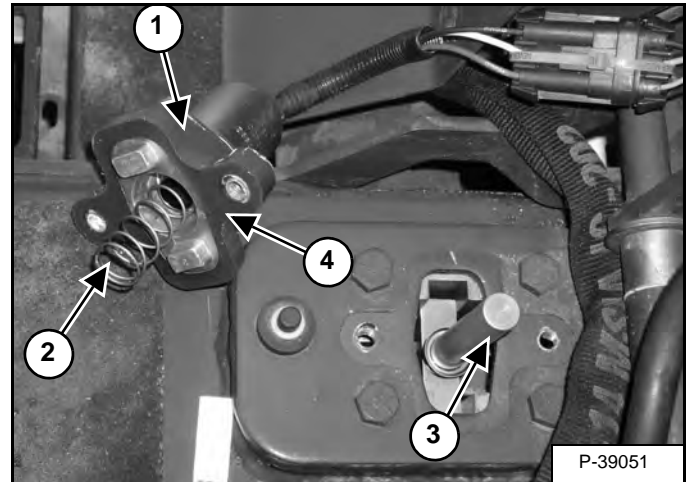

Remove the electric solenoid / mounting bracket assembly (Item 1) [Figure 60-100-2] from the chaincase cover.

Remove and inspect the compression spring (Item 2) [Figure 60-100-2] for wear and damage. Replace if necessary. The spring may also stay with the shaft when the electric solenoid and bracket are removed from the chaincase.

Installation: Install the compression spring (Item 2) [Figure 60-100-2] on the collar located on the electric solenoid.

Remove the traction lock assembly (Item 3) [Figure 60-100-2] from the chaincase.

Check the gasket (Item 4) [Figure 60-100-2] condition and replace as needed.

TRACTION LOCK (CONT'D)

Removal And Installation (Cont'd)

IMPORTANT

Failure to use Loctite® may allow the traction lock assembly to loosen up which can cause damage to the traction lock system.

I-2090-1095

Figure 60-100-3

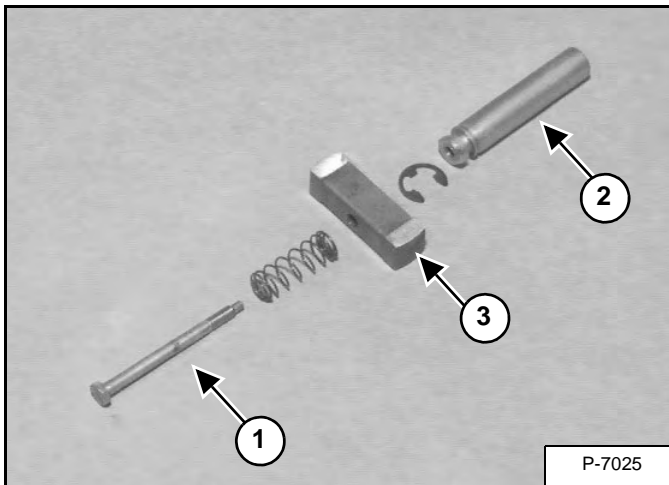

Remove the shaft mounting bolt (Item 1), washer and spring from the assembly shaft (Item 2). Remove the wedge (Item 3) [Figure 60-100-3] and inspect all parts for damage or wear. Replace if necessary.

Installation: Thoroughly clean and dry the shaft mounting bolt (Item 1), the shaft (Item 2), and wedge (Item 3) [Figure 60-100-3]. Use Loctite® #242 when assembling these parts to the traction lock assembly.

Refer to ELECTRICAL SYSTEMS AND ANALYSIS, (See Raising on Page 10-30-2.) Page 60-01 for the traction lock inspection procedure.



Bobcat®

BACK-UP ALARM SYSTEM (S/N A3W611001 - A3W613689 AND A3W711001 - A3W713379)

Description

This machine may be equipped with a back-up alarm system. The back-up alarm will sound when the operator moves both steering levers into the reverse position. Slight movement of the steering levers into the reverse position is required with hydrostatic transmissions, before the back-up alarm will sound.

Inspecting

Figure 60-110-1



Inspect for damaged or missing back-up alarm decal (Item 1) [Figure 60-110-1]. Replace if required.

Sit in the seat and fasten the seat belt. Engage the parking brake. Pull the seat bar all the way down. Start the engine. Press the PRESS TO OPERATE LOADER button. Disengage the parking brake.

Move both steering levers into the reverse position. The back-up alarm must sound when all wheels or both tracks are moving in reverse.

The back-up alarm is located on the inside of the rear door.

Figure 60-110-2

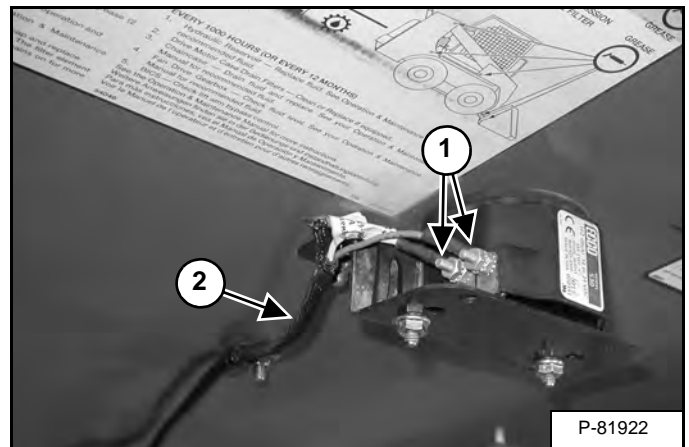

Inspect the back-up alarm electrical connections (Item 1) [Figure 60-110-2], wire harness (Item 2) [Figure 60-110-2] and back-up alarm switches (Item 2) [Figure 60-110-3 on Page 60-110-2] for tightness and damage. Repair or replace any damaged components.

If the back-up alarm switches require adjustment, (See Adjusting Switch Position on Page 60-110-2.)

BACK-UP ALARM SYSTEM (S/N A3W611001 - A3W613689 AND A3W711001 - A3W713379) (CONT'D)

Adjusting Switch Position

Stop the engine and exit the loader. (See STOPPING THE ENGINE AND LEAVING THE LOADER on Page 10-220-1.)

Raise the operator cab. (See OPERATOR CAB on Page 10-30-1.)

Earlier Models

Place the steering levers in the NEUTRAL position.

Figure 60-110-3

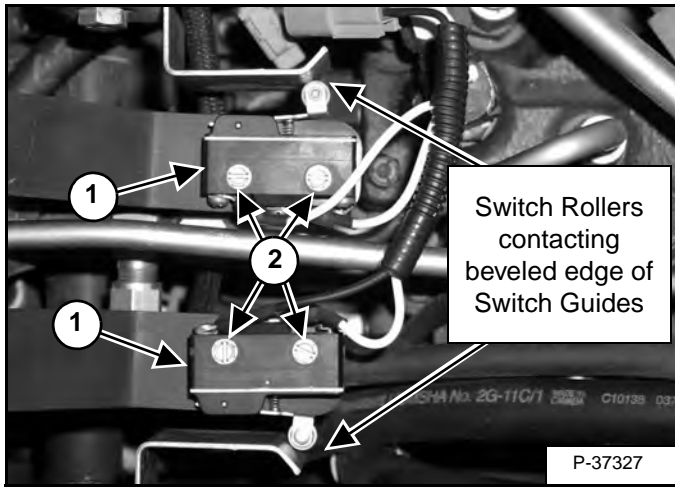

Loosen the screws (Item 2) securing the back-up alarm switches (Item 1) [Figure 60-110-3].

Position the back-up alarm switch rollers so that they just make contact with the beveled edge of the switch guides without compressing the switch springs. Torque the screws (Item 2) [Figure 60-110-3] securing the switches to the bracket to 1,6 - 2,1 N•m (14 - 19 in-lb).

Later Models

Figure 60-110-4

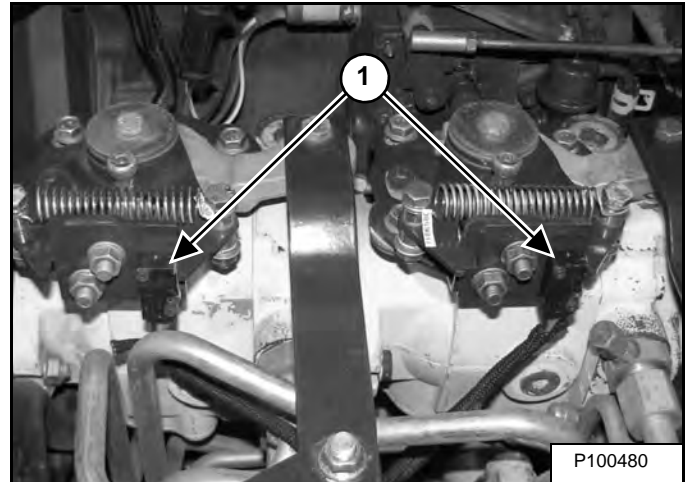

The back-up alarm switches (Item 1) [Figure 60-110-4] are located on the hydrostatic pump controls.

NOTE: The back-up alarm switches on later model loaders do not require adjustment.

All Models

Lower the operator cab. (See Lowering on Page 10-30-3.)

Inspect back-up alarm system for proper function. (See Inspecting on Page 60-110-1.)

BACK-UP ALARM SYSTEM (S/N A3W611001 - A3W613689 AND A3W711001 - A3W713379) (CONT'D)

Troubleshooting

The following troubleshooting chart is provided for assistance in locating and correcting problems which are most common. Many of the recommended procedures must be done by authorized Bobcat Service Personnel only.



AVOID INJURY OR DEATH

Instructions are necessary before operating or servicing machine. Read and understand the Operation & Maintenance Manual, Operator's Handbook and signs (decals) on machine. Follow warnings and instructions in the manuals when making repairs, adjustments or servicing. Check for correct function after adjustments, repairs or service. Untrained operators and failure to follow instructions can cause injury or death.

W-2003-0807

PROBLEM	CAUSE
Back-up alarm will not sound when the operator moves both steering levers in the reverse position.	1, 2, 3, 4, 5, 6, 7
Back-up alarm sounds when steering levers in neutral / forward position.	2, 6, 7

KEY TO CORRECT THE CAUSE	
	1. The ground connection is not making a good contact.
	2. The back-up alarm switches are damaged.
	3. The alarm is damaged.
	4. The alarm or back-up switch wires are disconnected.
	5. Check the fuses.
	6. The wiring is damaged.
	7. The back-up alarm switches need adjusting.

**BACK-UP ALARM SYSTEM (S/N A3W611001 -
A3W613689 AND A3W711001 - A3W713379)
(CONT'D)**

Alarm Removal And Installation

Stop the engine and open the tailgate.

Figure 60-110-5

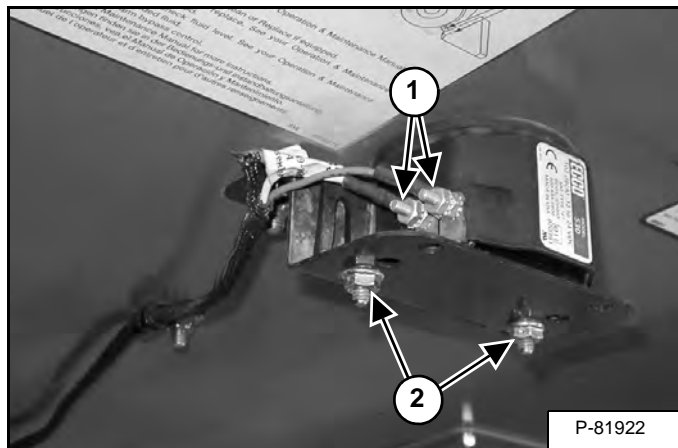

Mark the wires for ease of assembly. Disconnect the wires (Item 1) [Figure 60-110-5] from the alarm.

Remove the two hex head bolts, washers, and locknuts (Item 2) [Figure 60-110-5]. Remove the alarm from the mounting bracket.

Installation: Make sure the wire harness ends do not touch the mounting bolts during assembly.

**BACK-UP ALARM SYSTEM (S/N A3W611001 - A3W613689 AND A3W711001 - A3W713379)
(CONT'D)**

Switch Removal And Installation

Stop the engine and raise the operator cab. (See Raising on Page 10-30-2.)

Place the steering levers in the neutral position.

Remove the screws (Item 1) and plates securing the back-up alarm switches.

Remove the switch assemblies (Item 2) [Figure 60-110-5] from the mounting bracket.

Installation: Install the alarm switches onto the mounting bracket so the threaded plates are under the mounting bracket. The rollers will face to the outside. During installation of switches, adjusting the switches (See Adjusting Switch Position on Page 60-110-2.) and inspecting back-up alarm operation (See Inspecting on Page 60-110-1.) are required.

Figure 60-110-6

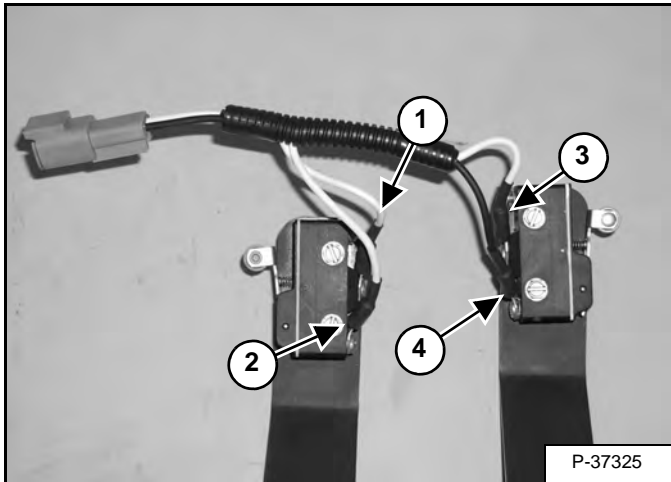

Mark the wires for ease of assembly.

Disconnect the White wire from the normally open terminal (Item 1) [Figure 60-110-6].

Disconnect the White wire from the common terminal (Item 2) [Figure 60-110-6].

Disconnect the White wire from the normally open terminal (Item 3) [Figure 60-110-6].

Disconnect the Black wires from the common terminal (Item 4) [Figure 60-110-6].

Remove the switches.



Bobcat®

BACK-UP ALARM SYSTEM (S/N A3W613690 & ABOVE, A3W713380 & ABOVE, B38V11001 & ABOVE, B38W11001 & ABOVE)

Description

This machine may be equipped with a back-up alarm system. The back-up alarm will sound when the operator moves both steering levers into the reverse position. Slight movement of the steering levers into the reverse position is required with hydrostatic transmissions, before the back-up alarm will sound.

Inspecting

Figure 60-111-1

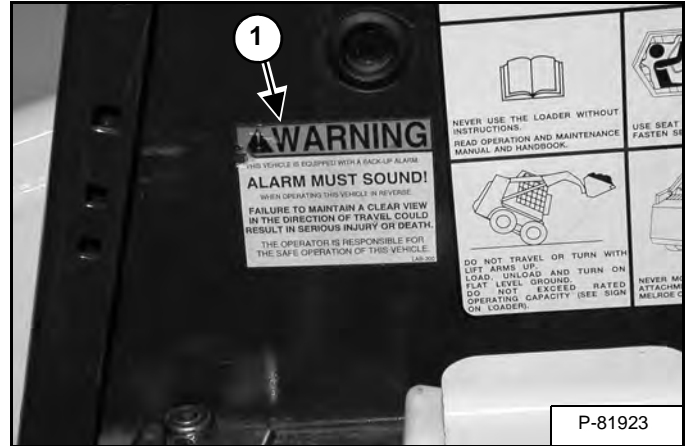

Inspect for damaged or missing back-up alarm decal (Item 1) [Figure 60-111-1]. Replace if required.

Sit in the seat and fasten the seat belt. Engage the parking brake. Pull the seat bar all the way down. Start the engine. Press the PRESS TO OPERATE LOADER button. Disengage the parking brake.

Move both steering levers into the reverse position. The back-up alarm must sound when all wheels or both tracks are moving in reverse.

The back-up alarm is located on the inside of the rear door.

Figure 60-111-2

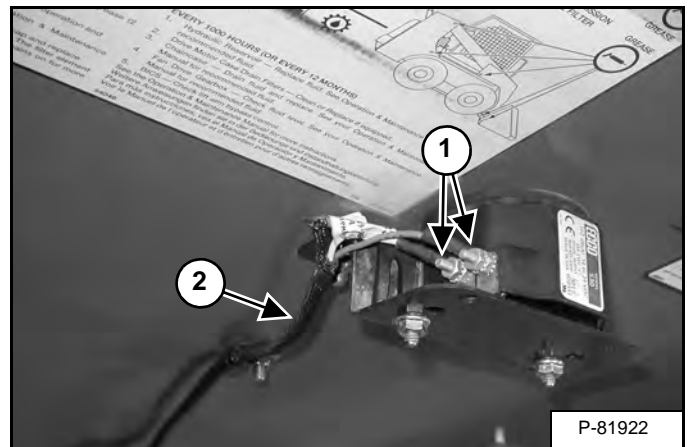

Inspect the back-up alarm electrical connections (Item 1) [Figure 60-111-2], wire harness (Item 2) [Figure 60-111-2] and back-up alarm switches (Item 2) [Figure 60-111-3 on Page 60-111-3] for tightness and damage. Repair or replace any damaged components.

BACK-UP ALARM SYSTEM (S/N A3W613690 & ABOVE AND A3W713380 & ABOVE, B38V11001 & ABOVE, B38W11001 & ABOVE) (CONT'D)

Troubleshooting

The following troubleshooting chart is provided for assistance in locating and correcting problems which are most common. Many of the recommended procedures must be done by authorized Bobcat Service Personnel only.



WARNING

AVOID INJURY OR DEATH

Instructions are necessary before operating or servicing machine. Read and understand the **Operation & Maintenance Manual, Operator's Handbook and signs (decals)** on machine. Follow warnings and instructions in the manuals when making repairs, adjustments or servicing. Check for correct function after adjustments, repairs or service. Untrained operators and failure to follow instructions can cause injury or death.

W-2003-0807

PROBLEM	CAUSE
Back-up alarm will not sound when the operator moves both steering levers in the reverse position.	1, 2, 3, 4, 5, 6, 7
Back-up alarm sounds when steering levers in neutral / forward position.	2, 6, 7

KEY TO CORRECT THE CAUSE	
	1. The ground connection is not making a good contact.
	2. The back-up alarm switches are damaged.
	3. The alarm is damaged.
	4. The alarm or back-up switch wires are disconnected.
	5. Check the fuses.
	6. The wiring is damaged.
	7. The back-up alarm switches need adjusting.

BACK-UP ALARM SYSTEM (S/N A3W613690 & ABOVE AND A3W713380 & ABOVE, B38V11001 & ABOVE, B38W11001 & ABOVE) (CONT'D)

Switch Removal And Installation

Stop the engine and raise the operator cab. (See Raising on Page 10-30-2.)

Figure 60-111-3

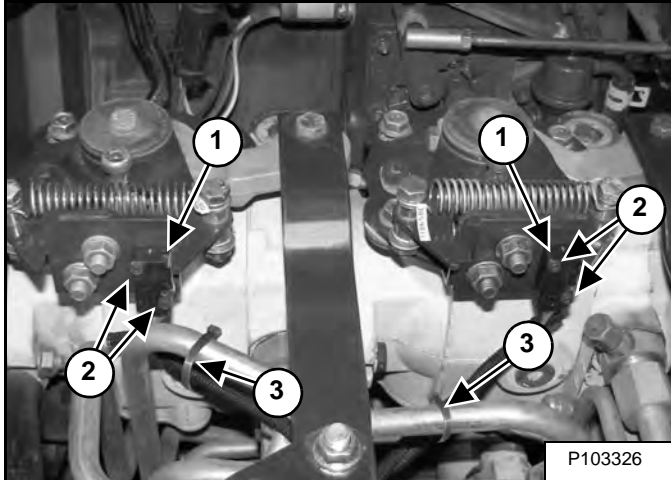

The back-up alarm switches (Item 1) [Figure 60-111-3] are located on the hydrostatic pump controls.

The back-up alarm switches (Item 1) [Figure 60-111-3] do not require adjustment.

Remove the two screws and nuts (Item 2) (both sides) and remove the switches.

Installation: Tighten the two nuts to 0,39 - 0,59 N•m (3.5 - 5.2 in-lb) torque.

Remove the tie straps (Item 3) [Figure 60-111-3].

Figure 60-111-4

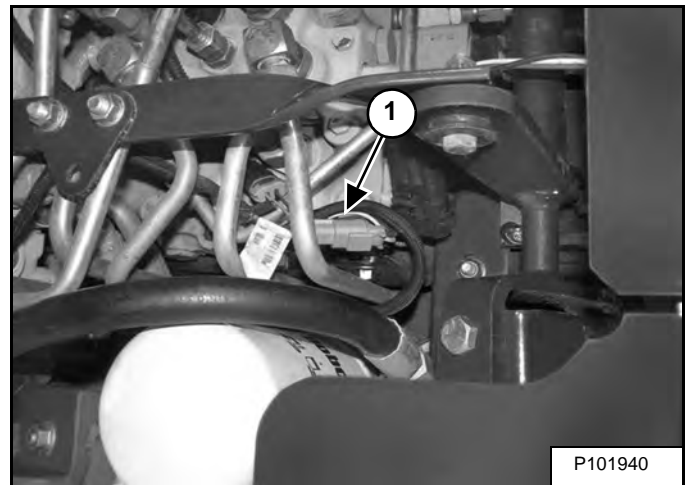

Disconnect the switch harness (Item 1) [Figure 60-111-4] from the loader harness.

BACK-UP ALARM SYSTEM (S/N A3W613690 & ABOVE AND A3W713380 & ABOVE, B38V11001 & ABOVE, B38W11001 & ABOVE) (CONT'D)

Alarm Removal And Installation

Stop the engine and open the tailgate.

Figure 60-111-5

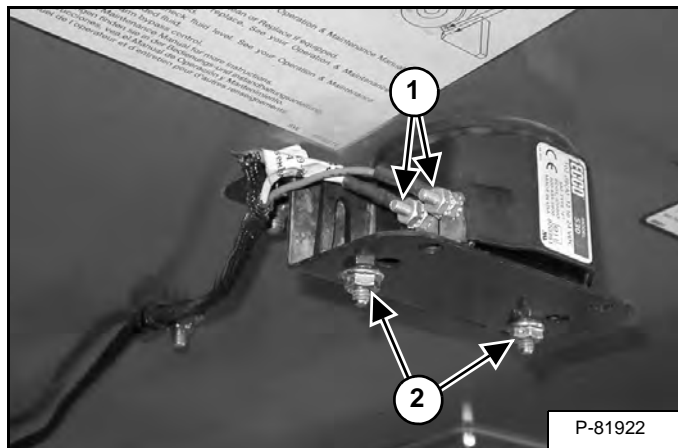

Mark the wires for ease of assembly. Disconnect the wires (Item 1) [Figure 60-111-5] from the alarm.

Remove the two hex head bolts, washers, and locknuts (Item 2) [Figure 60-111-5]. Remove the alarm from the mounting bracket.

Installation: Make sure the wire harness ends do not touch the mounting bolts during assembly.

BACK-UP ALARM SYSTEM (S/N B4TY11001 & ABOVE AND B4UC11001 & ABOVE)

Description

This machine may be equipped with a back-up alarm system. The back-up alarm will sound when the operator moves both steering levers into the reverse position. Slight movement of the steering levers into the reverse position is required with hydrostatic transmissions, before the back-up alarm will sound.

Inspecting

Figure 60-112-1

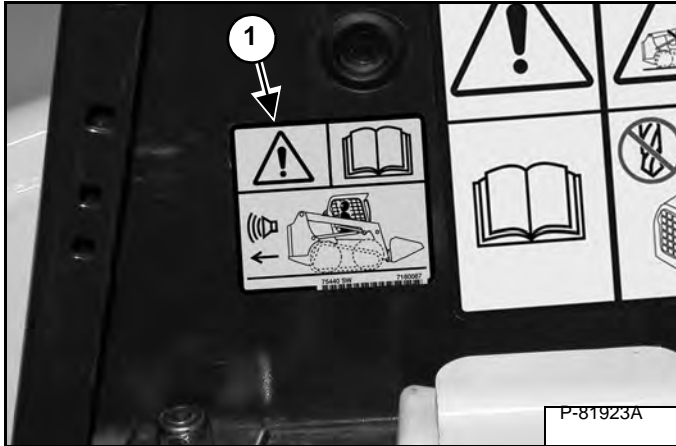

Inspect for damaged or missing back-up alarm decal (Item 1) [Figure 60-112-1]. Replace if required.

Sit in the seat and fasten the seat belt. Engage the parking brake. Pull the seat bar all the way down. Start the engine. Press the PRESS TO OPERATE LOADER button. Disengage the parking brake.

Move both steering levers into the reverse position. The back-up alarm must sound when all wheels or both tracks are moving in reverse.

The back-up alarm is located on the inside of the rear door.

Figure 60-112-2

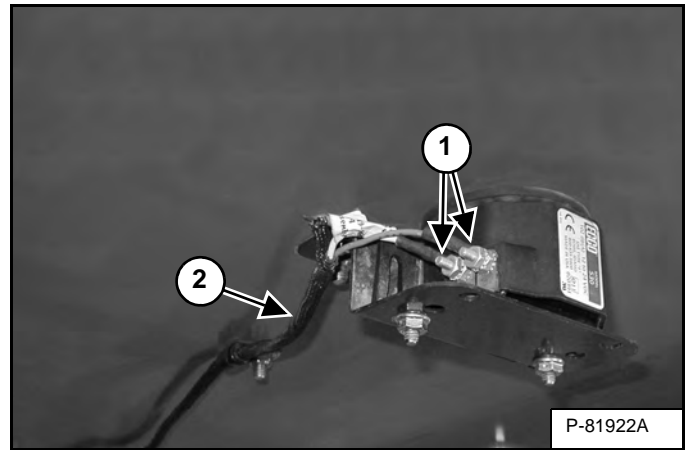

Inspect the back-up alarm electrical connections (Item 1) and wire harness (Item 2) [Figure 60-112-2] for tightness and damage. Repair or replace any damaged components.

If the back-up alarm switches require adjustment, (See Adjusting Switch Position on Page 60-112-1.)

Adjusting Switch Position

The back-up alarm switches do not require adjustment. See your Bobcat dealer for service if your back-up alarm does not sound.

BACK-UP ALARM SYSTEM (S/N B4TY11001 & ABOVE AND B4UC11001 & ABOVE) (CONT'D)

Troubleshooting

The following troubleshooting chart is provided for assistance in locating and correcting problems which are most common. Many of the recommended procedures must be done by authorized Bobcat Service Personnel only.



AVOID INJURY OR DEATH

Instructions are necessary before operating or servicing machine. Read and understand the Operation & Maintenance Manual, Operator's Handbook and signs (decals) on machine. Follow warnings and instructions in the manuals when making repairs, adjustments or servicing. Check for correct function after adjustments, repairs or service. Untrained operators and failure to follow instructions can cause injury or death.

W-2003-0807

PROBLEM	CAUSE
Back-up alarm will not sound when the operator moves both steering levers in the reverse position.	1, 2, 3, 4, 5, 6, 7
Back-up alarm sounds when steering levers in neutral / forward position.	2, 6, 7

KEY TO CORRECT THE CAUSE

	1. The ground connection is not making a good contact.
	2. The back-up alarm switches are damaged.
	3. The alarm is damaged.
	4. The alarm or back-up switch wires are disconnected.
	5. Check the fuses.
	6. The wiring is damaged.
	7. The back-up alarm switches need adjusting.

BACK-UP ALARM SYSTEM (S/N B4TY11001 & ABOVE AND B4UC11001 & ABOVE) (CONT'D)

Alarm Removal And Installation

Stop the engine and open the tailgate.

Figure 60-112-3

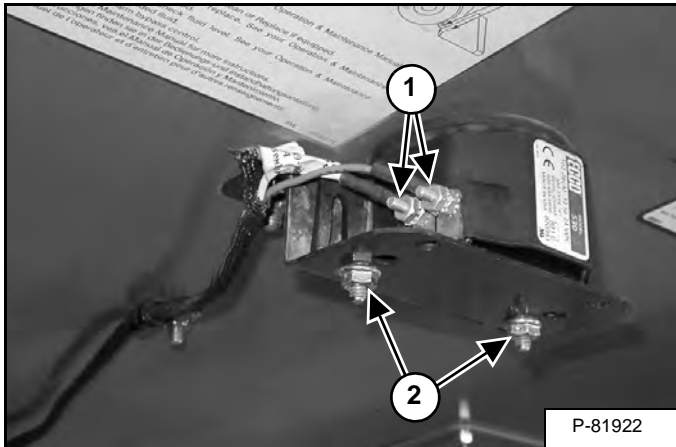

Mark the wires for ease of assembly. Disconnect the wires (Item 1) [Figure 60-112-3] from the alarm.

Remove the two hex head bolts, washers, and locknuts (Item 1) [Figure 60-112-3]. Remove the alarm from the mounting bracket.

Installation: Make sure the wire harness ends do not touch the mounting bolts during assembly.

Switch Removal And Installation

Stop the engine and raise the operator cab. (See Raising on Page 10-30-2.)

Place the steering levers in the neutral position.

Remove the screws (Item 1) and plates securing the back-up alarm switches.

Remove the switch assemblies (Item 2) [Figure 60-112-3] from the mounting bracket.

Installation: Install the alarm switches onto the mounting bracket so the threaded plates are under the mounting bracket. The rollers will face to the outside. During installation of switches, adjusting the switches (See Adjusting Switch Position on Page 60-112-1.) and inspecting back-up alarm operation (See Inspecting on Page 60-112-1.) are required.

Figure 60-112-4

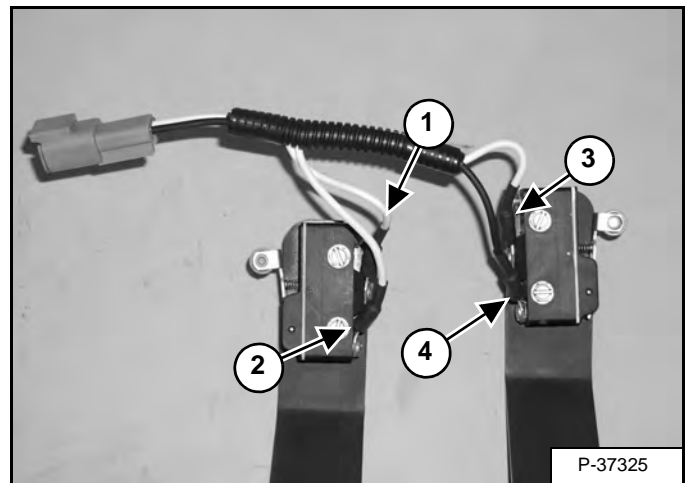

Mark the wires for ease of assembly.

Disconnect the White wire from the normally open terminal (Item 1) [Figure 60-112-4].

Disconnect the White wire from the common terminal (Item 2) [Figure 60-112-4].

Disconnect the White wire from the normally open terminal (Item 3) [Figure 60-112-4].

Disconnect the Black wires from the common terminal (Item 4) [Figure 60-112-4].

Remove the switches.



Bobcat®

ENGINE SERVICE

ENGINE INFORMATION	70-10-1
Description	70-10-1
Specifications	70-10-2
Torque Values	70-10-6
Troubleshooting	70-10-7
Engine Removal And Installation	70-10-9
Engine Mount Replacement	70-10-15
Compression - Checking	70-10-16
ENGINE SPEED CONTROL	70-20-1
Removal And Installation	70-20-1
MUFFLER	70-30-1
Removal And Installation	70-30-1
AIR CLEANER	70-40-1
Housing Removal And Installation	70-40-1
ENGINE COOLING SYSTEM	70-50-1
Radiator Removal And Installation	70-50-1
Fan Removal And Installation	70-50-3
Water Pump Removal And Installation	70-50-3
Water Pump Disassembly And Assembly	70-50-4
Thermostat Housing Removal And Installation	70-50-4
LUBRICATION SYSTEM	70-60-1
Oil Pan Removal And Installation	70-60-1
Oil Pump Removal And Installation	70-60-2
Oil Pump Inspection	70-60-2
Engine Oil Pressure - Testing	70-60-4
FUEL SYSTEM	70-70-1
Fuel Camshaft Removal And Installation	70-70-1
Governor Shaft Removal And Installation	70-70-3
Governor Fork Lever Removal And Installation	70-70-6
Fuel ShutOff Solenoid - Checking	70-70-8
Fuel ShutOff Solenoid Removal And Installation	70-70-8
Fuel Injection Pump Removal And Installation	70-70-9
Fuel Injection Pump Timing	70-70-11
Fuel Injector Nozzles Removal And Installation	70-70-12
Fuel Injector Nozzle Pressure - Checking	70-70-13
Nozzle Spray Condition	70-70-14
Valve Seat Tightness	70-70-15

CYLINDER HEAD	70-80-1
Glow Plug - Checking	70-80-1
Glow Plug Removal And Installation	70-80-1
Valve Clearance Adjustment	70-80-2
Valve Timing Checking	70-80-3
Cylinder Head Removal And Installation	70-80-3
Cylinder Head Disassembly And Assembly	70-80-6
Cylinder Head - Servicing	70-80-6
Cylinder Head Top Clearance	70-80-7
Valve Guide - Checking	70-80-7
Reconditioning The Valve And Valve Seat	70-80-9
Valve Spring	70-80-10
Valve Tappets	70-80-11
Rocker Arm And Shaft - Checking	70-80-11
CRANKSHAFT AND PISTONS	70-90-1
Piston And Connecting Rod Removal And Installation	70-90-1
Piston And Connecting Rod - Servicing	70-90-2
Cylinder Bore - Checking	70-90-5
Connecting Rod Alignment	70-90-5
Crankshaft And Bearings Removal And Installation	70-90-6
Crankshaft And Bearings - Servicing	70-90-8
CAMSHAFT AND TIMING GEARS	70-100-1
Timing Gearcase Cover Removal And Installation	70-100-1
Timing Gears Backlash - Checking	70-100-3
Idler Gear And Shaft Removal And Installation	70-100-3
Camshaft - Servicing	70-100-4
Idler Gear And Shaft Servicing	70-100-6
FLYWHEEL AND HOUSING	70-110-1
Flywheel Removal And Installation	70-110-1
Ring Gear Removal And Installation	70-110-1
Housing Removal And Installation	70-110-2

ENGINE INFORMATION

Description

The S70 has an indirect injected Kubota® D1005 diesel engine with a displacement of 1,0 L (61.08 in³). The engine is rated at 23.5 hp (17,5 kW/h) and has a closed crankcase ventilation system.

The engine has three cylinders and the rotation is counter-clockwise (viewed from the flywheel side). Engine block heaters are also available from Bobcat parts.

The engine serial number is stamped on the engine and is located below the exhaust manifold. The model number is located on the valve cover. Use these numbers to obtain the correct service parts.

The engine is liquid cooled with a propylene glycol / water mixture. The cooling fans are electrically driven. The speed of the fans are determined by the engine coolant temperature sensor.

ENGINE INFORMATION (CONT'D)

Specifications

Fuel Injection Nozzles

Opening Pressure	13734 - 14707 kPa (137 - 147 bar) (1992 - 2133 psi)
Fuel Tightness Nozzle Seat	12748 kPa (127,5 bar) (1849 psi)

Fuel Injection Pump

Fuel Tightness of Plunger Limit Permitted	14707 kPa (147 bar) (2133 psi)
Fuel Tightness of Delivery Valve	13727 - 12748 kPa (137,3 - 127,5 bar) (10 Sec: Initial Pressure Drop From 1991-1849 psi)
Allowable Limit	13727 - 12748 kPa (137,3 - 127,5 bar) (5 Sec: Initial Pressure Drop From 1991 - 1849 psi)
Injection Timing	17 - 19° B.T.D.C.

Cylinder Head

Flatness Limit Permitted	0,05 mm (0.0020 in)
Top Clearance (Piston to Head)	0,55 - 0,75 mm (0.022 - 0.029 in)
Compression	3730 - 4116 kPa (37,3 - 41,2 bar) (541 - 597 psi)
Allowable Limit (minimum)	2255 kPa (22,5 bar) (327 psi)

Valves

Valve Seat Angle	60° intake 45° exhaust
Valve Seat Width	2,12 mm (0.0835 in)
O.D. of Valve Stem	6,960 - 6,975 mm (0.2741 - 0.2746 in)
I.D. of Valve Guide	7,010 - 7,025 mm (0.2760 - 0.2765 in)
Clearance between Valve Stem And Guide	0,035 - 0,065 mm (0.0014 - 0.0025 in)
Allowable Limit	0,1 mm (0.0039 in)
Depth of Valve *negative value	*0,0020 - 0,0098 mm *(0,05 - 0,25 in)
Allowable Limit	0,40 mm (0.016 in)
Valve Clearance (Cold) (Intake And Exhaust)	0,145 - 0,185 mm (0.0057 - 0.0073 in)

ENGINE INFORMATION (CONT'D)

Specifications (Cont'd)

Valve Springs

Free Length	37,0 - 37,5 mm (1.46 - 1.47 in)
Limit Permitted	36,5 mm (1.44 in)
Fitted Length	31,0 mm (1.22 in)
Load To Compress To Fitted Length	117,4 N (26.4 ft-lb)
Allowable Limit	100 N (22.5 ft-lb)
Allowable Limit for Spring Tilt	1,0 mm (0.039 in)

Rocker Arms

O.D. of Rocker Arm Shaft	11,973 - 11,984 mm (0.4714 - 0.4718 in)
I.D. of Rocker Arm	12,000 - 12,018 mm (0.4724 - 0.4731 in)
Clearance Between Rocker Arm Shaft And Rocker Arm	0,016 - 0,045 mm (0.0006 - 0.0018 in)
Allowable Limit	0,10 mm (0.0039 in)

Camshaft

O.D. of Camshaft Bearing Journal	35,934 - 35,950 mm (1.4148 - 1.4153 in)
I.D. of Camshaft Bearing	36,000 - 36,025 mm (1.4174 - 1.4183 in)
Clearance Between Camshaft Bearing And Journal	0,050 - 0,091 mm (0.002 - 0.0035 in)
Allowable Limit	0,15 mm (0.0059 in)
Alignment of the Camshaft	0,01 mm (0.0004 in)
Intake Lobe Height	28,80 mm (1.134 in)
Exhaust Lobe Height	29,00 mm (1.1417 in)
Gear Backlash	0,036 - 0,114 mm (0.0014 - 0.0045 in)
Allowable Limit	0,15 mm (0.0059 in)

ENGINE INFORMATION (CONT'D)

Specifications (Cont'd)

Cylinders

I.D. of Cylinder Liner	76,000 - 76,019 mm (2.9922 - 2.9928 in)
Allowable Limit	76,15 mm (2.998 in)
Oversized Cylinder Liner (Bore) I.D.	76,500 - 76,519 mm (3.0119 - 3.0125 in)
Allowable Limit	76,65 mm (3.018 in)

Piston Rings

Top And 2nd Ring Gap	0,30 - 0,45 mm (0.0118 - 0.0177 in)
Oil Ring Gap	0,25 - 0,40 mm (0.0098 - 0.0157 in)
Allowable Limit (Top, 2nd And Oil Ring)	1,25 mm (0.0492 in)
Side Clearance Of Ring Groove:	
Top Ring	Because of our top ring design, measurement does not apply
2nd Ring	0,085 - 0,112 mm (0.0033 - 0.0044 in)
Allowable Limit	0,20 mm (0.008 in)
Oil Ring	0,020 - 0,055 mm (0,0008 - 0,0021 in)
Allowable Limit	0,15 mm (0.0059 in)
Oversize of Piston And Ring	+ 0,5 mm (+ 0.0197 in)

Pistons

I.D. of Piston Bore	22,000 - 22,013 mm (0.8661 - 0.8667 in)
Allowable Limit	22,03 mm (0.8673 in)
O.D. of Piston Pin	22,002 - 22,011 mm (0.8662 - 0.8666 in)
I.D. of Connecting Rod Bushing (Small End, Fitted)	22,025 - 22,040 mm (0.8671 - 0.8677 in)
Oil Clearance Between Piston Pin And Bushing Limit Permitted	0,15 mm (0.0059 in)
Connecting Rod Alignment Limit Permitted	0,05 mm (0.002 in)

ENGINE INFORMATION (CONT'D)

Specifications (Cont'd)

Crankshaft

Crankshaft Alignment Limit Permitted	0,02 mm (0.0008 in)
O.D. of Crankshaft Journal No. 1	47,934 - 47,950 mm (1.8872 - 1.8878 in)
I.D. of Crankshaft Bearing No. 1	47,984 - 48,048 mm (1.8891 - 1.8917 in)
Oil Clearance Between No.1 Crankshaft Journal and Bearing	0,034 - 0,114 mm (0.0013 - 0.0045 in)
Allowable Limit	0,20 mm (0.0079 in)
O.D. of Crankshaft Journal No. 2 and No. 3	47,934 - 47,950 mm (1.8872 - 1.8878 in)
I.D. of Crankshaft Bearing No. 2 and No. 3	47,984 - 48,029 mm (1.8891 - 1.8909 in)
Oil Clearance Between No. 2 and No. 3 Crankshaft Journals and Bearings	0,034 - 0,095 mm (0.0013 - 0.0037 in)
Allowable Limit	0,20 mm (0.0079 in)
O.D. of Crankshaft Journal No. 4	51,921 - 51,940 mm (2.0441 - 2.0449 in)
I.D. of Crankshaft Bearing No. 4	51,974 - 52,019 mm (2.0462 - 2.0480 in)
Oil Clearance Between No. 4 Crankshaft Journal and Bearing	0,034 - 0,098 mm (0.0013 - 0.0039 in)
Allowable Limit	0,20 mm (0.0079 in)
O.D. of Connecting Rod Journals	39,959 - 39,975 mm (1.5732 - 1.5738 in)
I.D. of Connecting Rod Bearings	40,004 - 40,050 mm (1.5750 - 1.5768 in)
Oil Clearance Between Connecting Rod Journals and Bearings	0,029 - 0,091mm (0.0011 - 0.0036 in)
Allowable Limit	0,2 mm (0.0079 in)
Crankshaft End Play	0,15 - 0,31 mm (0.0059 - 0.0122 in)
Allowable Limit	0,50 mm (0.0197 in)

Oil Pump

Oil Pressure @ Rated RPM	193 - 441 kPa (1,9 - 4,4 bar) (28 - 64 psi)
Oil Pressure @ Idle Speed	48 kPa (0,5 bar) (7 psi)

Thermostat

Opening Temperature	
Starting	70° - 73°C (157° - 163°F)
Fully Open	85°C (185°F)

ENGINE INFORMATION (CONT'D)

Torque Values

Kubota® Metric Engine Bolts

Thread Size (Dia. x Pitch)	Material		
	Head Mark 4	Head Mark 7	Head Mark 10
M5 x 0.8		4 - 5 N•m (3 - 4 ft-lb)	
M6 x 1.0		8 - 9 N•m (6 - 7 ft-lb)	8 - 12 N•m (6 - 9 ft-lb)
M8 x 1.25	8 - 12 N•m (6 - 9 ft-lb)	15 - 22 N•m (11 - 16 ft-lb)	24 - 34 N•m (18 - 25 ft-lb)
M10 x 1.25	18 - 24 N•m (13 - 18 ft-lb)	30 - 41 N•m (22 - 30 ft-lb)	49 - 68 N•m (36 - 50 ft-lb)
M12 x 1.25	30 - 41 N•m (22 - 30 ft-lb)	54 - 73 N•m (40 - 54 ft-lb)	94 - 118 N•m (69 - 87 ft-lb)
M14 x 1.5	49 - 68 N•m (36 - 50 ft-lb)	79 - 108 N•m (58 - 80 ft-lb)	157 - 186 N•m (116 - 137 ft-lb)

Tightening Torques For General Use Screws, Bolts And Nuts

Grade	Standard Screw and Bolt (4)			Special Screw and Bolt (7)		
	N-m	kgf-m	ft-lb	N-m	kgf-m	ft-lb
M6	7,9 - 9,3	0.80 - 0.95	5.8 - 6.9	9,8 - 11,3	1.00 - 1.15	7.23 - 8.32
M8	17,7 - 20,6	1.8 - 2.1	13.0 - 15.2	23,5 - 27,5	2.4 - 2.8	17.4 - 20.3
M10	39,2 - 45,1	4.0 - 4.6	28.9 - 33.3	49,0 - 55,9	5.0 - 5.7	36.2 - 41.2
M12	62,8 - 72,6	6.4 - 7.4	46.3 - 53.5	77,5 - 90,2	7.9 - 9.2	57.1 - 66.5

Screw and bolt material grades are shown by numbers punched on the screw and bolt heads. Prior to tightening, be sure to check out the numbers as shown below.

Punched number	Screw and bolt material grade
None or 4	Standard screw and bolt SS400, S20C
7	Special screw and bolt S43C, S48C (Refined)

ENGINE INFORMATION (CONT'D)

Troubleshooting

The following troubleshooting chart is provided for assistance in locating and correcting problems which are most common. Many of the recommended procedures must be done by authorized Bobcat Service Personnel only.



Check for correct function after adjustments, repairs or service. Failure to make correct repairs or adjustments can cause injury or death.

W-2004-1285

PROBLEM	CAUSE
Slow cranking speed.	1, 2, 3, 4
Engine will not start.	5, 6, 7, 8, 9, 10, 11, 12, 13, 14, 15, 16, 17, 18, 19, 20, 22, 30, 31, 32, 58
Difficult to start.	5, 6, 7, 8, 9, 10, 11, 12, 13, 14, 15, 16, 18, 19, 20, 21, 22, 23, 28, 30, 31, 32, 58
No power from the engine.	8, 9, 10, 11, 12, 13, 14, 18, 19, 20, 21, 22, 23, 24, 25, 26, 30, 31, 32
Engine is mis-firing.	8, 9, 10, 11, 12, 13, 14, 16, 18, 19, 20, 24, 25, 27, 28, 30, 31, 32
Too much fuel consumption.	11, 13, 14, 16, 18, 20, 22, 23, 24, 26, 27, 28, 30, 31, 32
Black exhaust.	11, 13, 14, 16, 18, 19, 20, 22, 23, 24, 26, 27, 28, 30, 31, 32
Blue / White exhaust.	4, 16, 18, 19, 20, 24, 26, 30, 32, 33, 34, 44, 54
Low oil pressure.	4, 35, 36, 37, 38, 39, 41, 42, 32, 56
Engine knocking.	9, 14, 16, 18, 19, 22, 25, 27, 28, 30, 32, 34, 35, 44, 45, 57
Engine running rough.	7, 8, 9, 10, 11, 12, 13, 14, 16, 20, 21, 25, 27, 28, 29, 32, 34, 44, 57
Vibration.	13, 14, 20, 24, 25, 28, 29, 32, 44, 47
High oil pressure.	4, 37, 40
Overheating.	11, 13, 14, 16, 18, 19, 23, 24, 44, 46, 48, 49, 50, 51, 52, 55
Too much crankcase pressure.	24, 30, 32, 33, 44, 53
Poor compression.	11, 19, 24, 27, 28, 30, 31, 32, 33, 45, 57
Start and stop.	10, 11, 12

ENGINE INFORMATION (CONT'D)

Troubleshooting (Cont'd)

KEY TO CORRECT THE CAUSE	
1. Battery capacity low.	31. Worn valves and seats.
2. Bad electrical connection.	32. Broken, worn or sticking piston rings.
3. Faulty starter motor.	33. Worn valve stems and guides.
4. Incorrect grade of oil.	34. Overly full air cleaner.
5. Low cranking speed.	35. Worn or damaged bearings.
6. Fuel tank empty.	36. Not enough oil in the oil pan.
7. Faulty stop control operation.	37. Gauge is not correct.
8. Plugged fuel line.	38. Oil pump worn.
9. Faulty fuel lift pump.	39. Pressure relief valve is open.
10. Plugged fuel filter.	40. Pressure relief valve is sticking closed.
11. Restriction in the air cleaner.	41. Broken relief valve spring.
12. Air in the fuel system.	42. Faulty suction pipe.
13. Faulty fuel injection pump.	43. Plugged oil filter.
14. Faulty fuel injectors.	44. Piston seizure.
15. Incorrect use of the glow plugs	45. Incorrect piston height.
16. Glow plugs not working.	46. Damaged fan.
17. Broken fuel injection pump drive.	47. Faulty engine mounting or loose mounting.
18. Incorrect fuel pump timing.	48. Faulty thermostat.
19. Incorrect valve timing.	49. Restriction in the water jacket.
20. Poor compression.	50. Loose fan belt.
21. Plugged fuel tank vent.	51. Plugged radiator.
22. Incorrect type or grade of fuel.	52. Faulty water pump.
23. Exhaust pipe restriction.	53. Plugged breather pipe.
24. Cylinder head gasket leaking.	54. Valve stem seals damaged.
25. Overheating.	55. Coolant level low.
26. Cold running.	56. Plugged oil pump pipe strainer.
27. Incorrect valve tappet adjustment.	57. Broken valve spring.
28. Sticking valves.	58. Hydraulics in Detent position or drive engaged.
29. Incorrect high pressure tubelines.	
30. Worn engine cylinder bores.	

ENGINE INFORMATION (CONT'D)

Engine Removal And Installation

! WARNING

Never work on a machine with the lift arms up unless the lift arms are secured by an approved lift arm support device. Failure to use an approved lift arm support device can allow the lift arms or attachment to fall and cause injury or death.

W-2059-0598

IMPORTANT

Always keep hydraulic and hydrostatic parts clean. Clean outside of all assemblies before beginning repairs. Use plugs and caps to cover open ports. Dirt can quickly damage the system.

I-2173-0598

NOTE: The engine and hydrostatic pumps are removed from the loader as an assembly.

Lift and block the loader. (See Procedure on Page 10-10-1.)

Raise the lift arms and install the lift arm support device. (See Installing on Page 10-20-1.)

Open the rear door.

Drain the hydraulic / hydrostatic fluid. (See Removing And Replacing Hydraulic / Hydrostatic Filter on Page 10-120-3.)

Remove the battery. (See Removal And Installation on Page 60-20-1.)

Raise the operator cab. (See Raising on Page 10-30-2.)

Figure 70-10-1

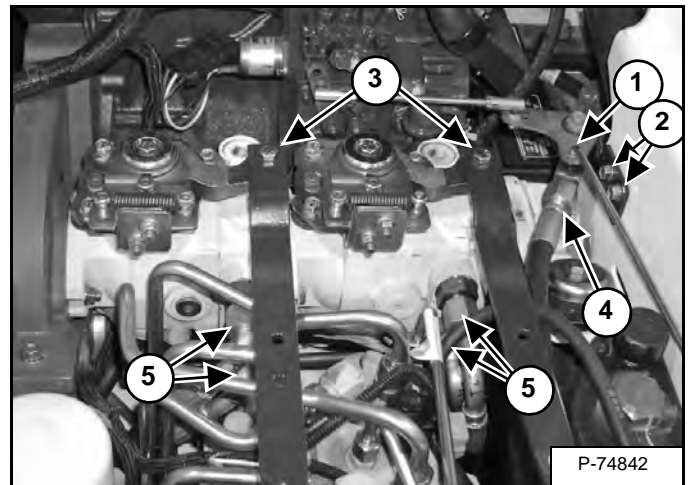

Disconnect the speed control linkage (Item 1) from the bellcrank. Remove the bellcrank mounting bracket from the mainframe by removing the two mounting bolts (Item 2) [Figure 70-10-1]. Secure the linkage rod and bellcrank to the engine to keep it out of the way.

Remove the nuts (Item 3) [Figure 70-10-1] from the steering lever linkage. Remove the linkage from the hydrostatic pumps.

Disconnect the outlet hose (Item 4) and high pressure hoses (Item 5) [Figure 70-10-1] from the hydraulic pump. Install caps and plugs on the fittings and hoses.

Figure 70-10-2

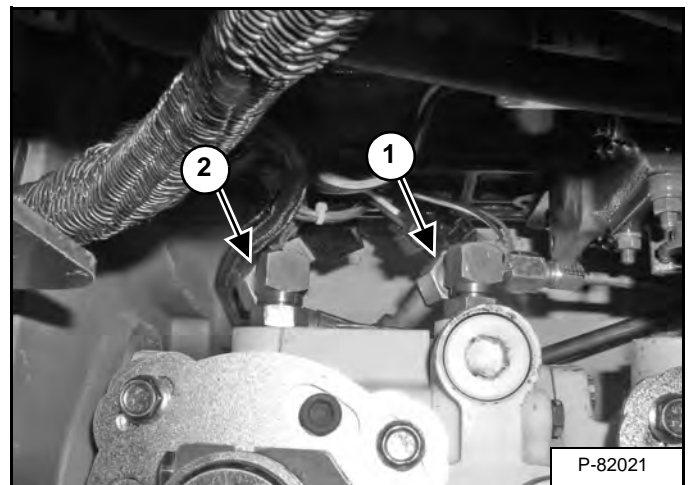

Disconnect the charge pressure hose (Item 1) and drain hose (Item 2) [Figure 70-10-2] from behind the hydrostatic pump. Install caps and plugs in the fittings and hoses.

ENGINE INFORMATION (CONT'D)

Engine Removal And Installation (Cont'd)

Figure 70-10-3

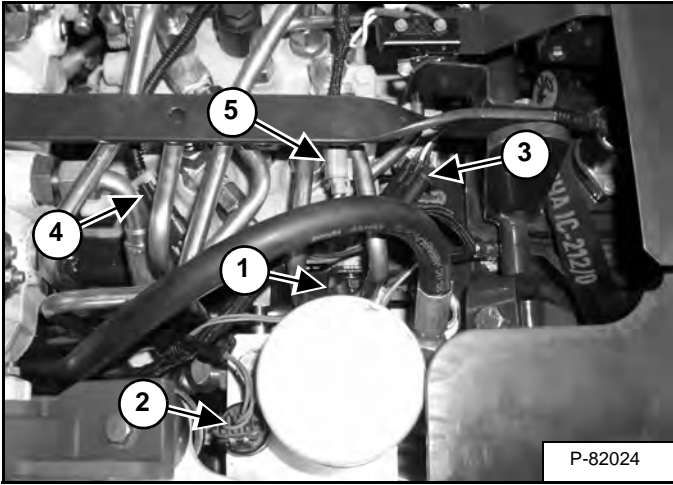

Disconnect the hydraulic oil temperature wire (Item 1) [Figure 70-10-3].

Disconnect the hydraulic oil pressure connector (Item 2) [Figure 70-10-3].

Disconnect the brake solenoid connector (Item 3) [Figure 70-10-3].

Disconnect the lift lock valve connector (Item 4) [Figure 70-10-3].

Disconnect the back-up alarm connector (Item 5) [Figure 70-10-3], if the loader is so equipped.

Figure 70-10-4

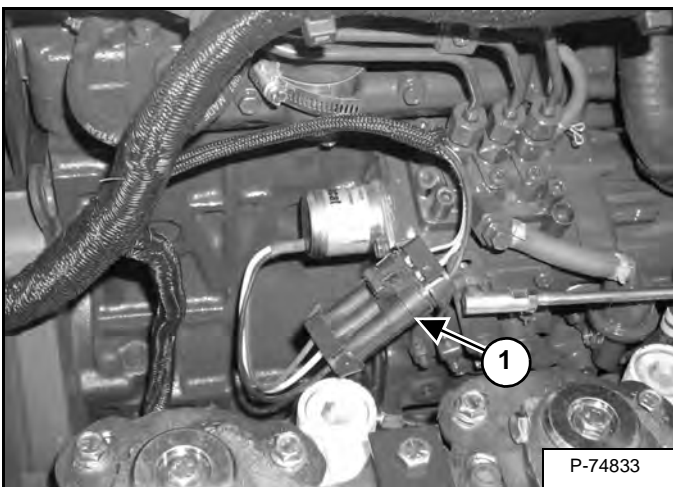

Disconnect the fuel solenoid connector (Item 1) [Figure 70-10-4].

Figure 70-10-5

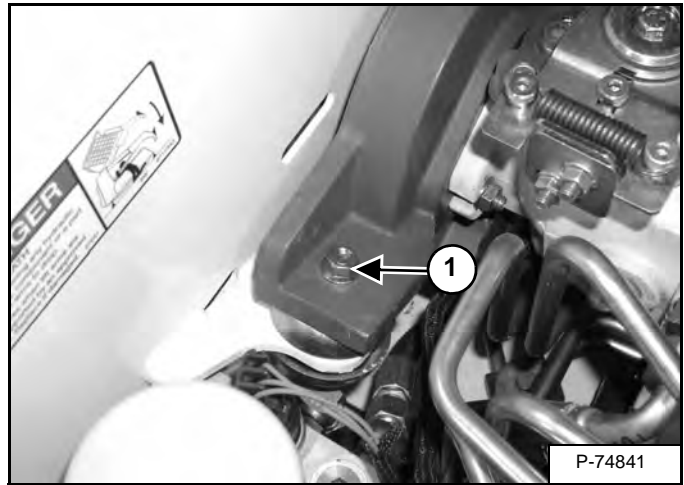
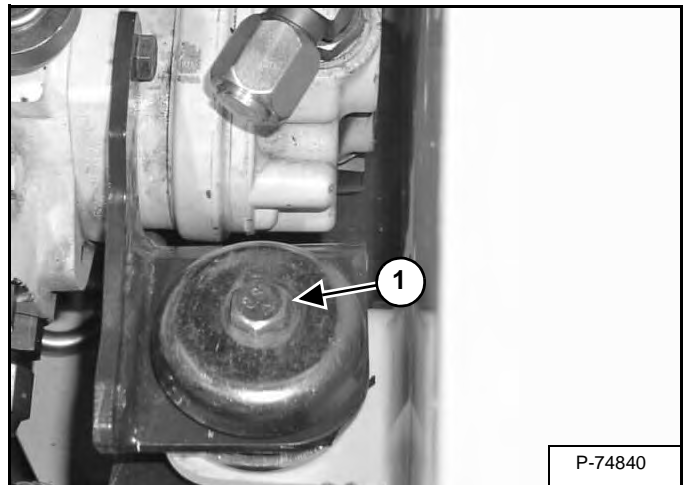

Figure 70-10-6



Remove the nuts, bolts, spacers and snubber cups (Item 1) [Figure 70-10-5] and [Figure 70-10-6] from the hydrostatic pump mounts.

Removing the rear tires will make this step easier.

Replace the engine mounts if they are damaged.

Installation: Tighten mounting bolts to 88 - 95 N•m (65 - 70 ft-lb) torque.

Lower the operator cab.

ENGINE INFORMATION (CONT'D)

Engine Removal And Installation (Cont'd)

Figure 70-10-7

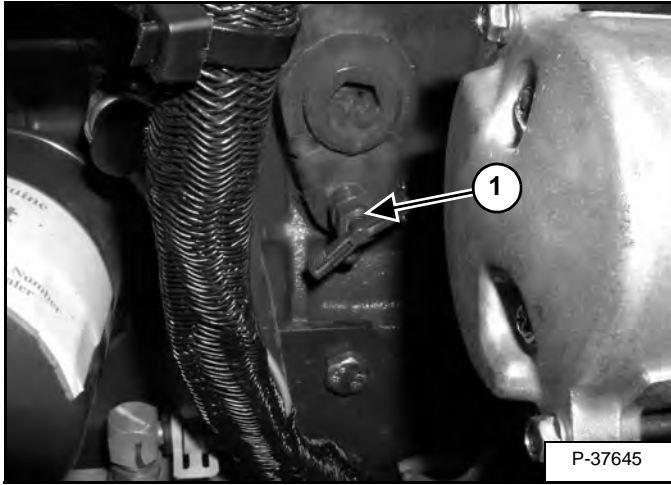

Open the coolant valve (Item 1) [Figure 70-10-7] to drain the coolant. (See Removing And Replacing Coolant on Page 10-90-3.)

Figure 70-10-8

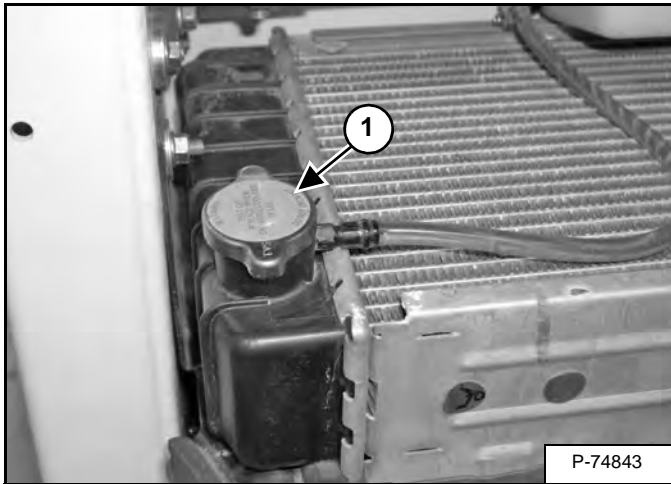

Open the radiator cap (Item 1) [Figure 70-10-8].

Remove the radiator and radiator mounting bracket. (See Radiator Removal And Installation on Page 70-50-1.)

Close the shutoff valve. (See FUEL SYSTEM on Page 10-100-1.)

Drain the fuel system. (See FUEL SYSTEM on Page 10-100-1.)

Figure 70-10-9

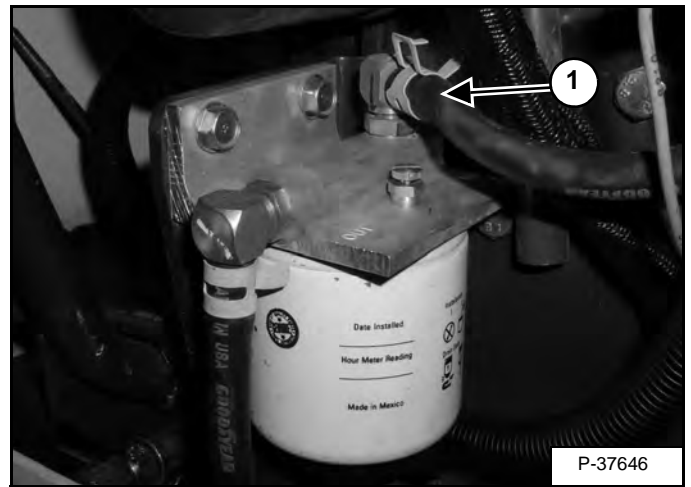

Remove and plug the fuel inlet hose (Item 1) [Figure 70-10-9] going to the fuel filter.

Figure 70-10-10

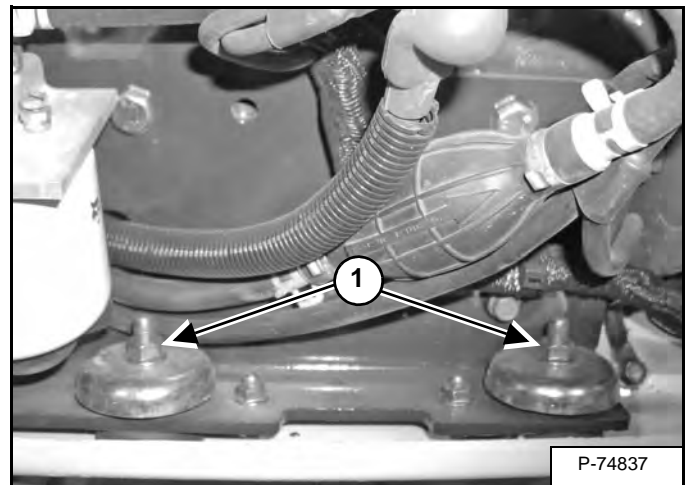

Remove the engine mounting bolts (Item 1) [Figure 70-10-10].

Replace the engine mounts if they are damaged.

Installation: Tighten mounting bolts to 88 - 95 N·m (65 - 70 ft-lb) torque.

ENGINE INFORMATION (CONT'D)

Engine Removal And Installation (Cont'd)

Figure 70-10-11

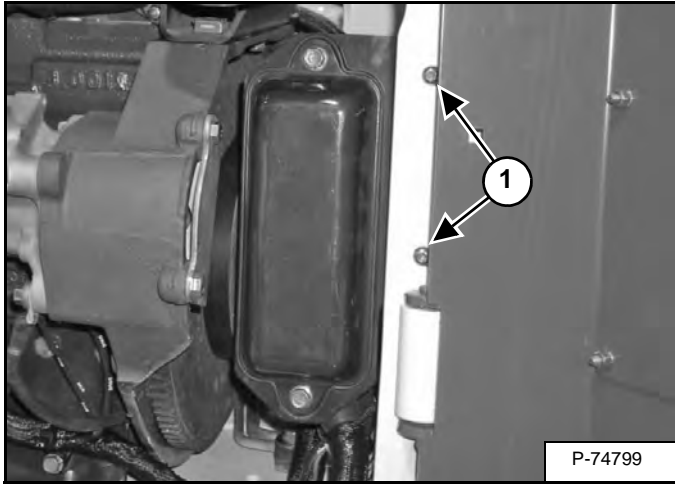

Remove the mounting bolts (Item 1) [Figure 70-10-11] from the fuse panel bracket.

Figure 70-10-12

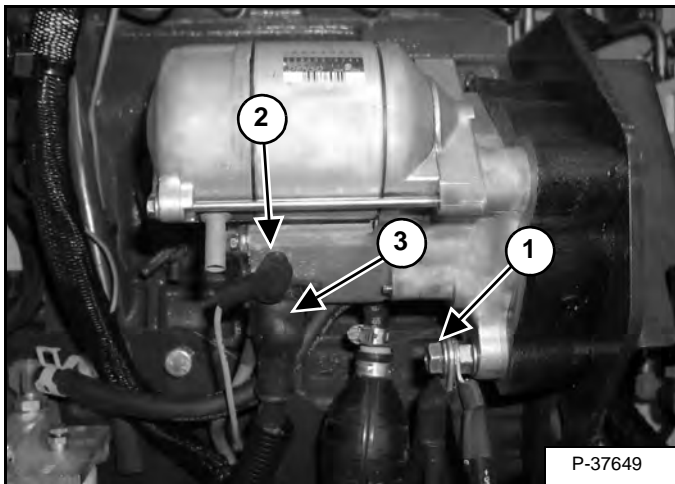

Remove the nut (Item 1) [Figure 70-10-12] from the starter mounting bolt and remove the battery and engine negative (-) cables and wires.

Remove the starter solenoid wire (Item 2) [Figure 70-10-12].

Remove the battery and engine positive (+) cables and wires (Item 3) [Figure 70-10-12] from the starter.

Figure 70-10-13

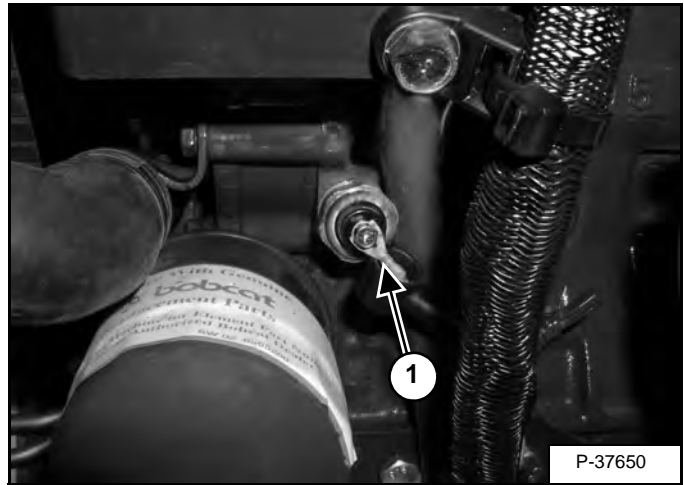

Remove the wire (Item 1) [Figure 70-10-13] from the oil pressure sender.

Figure 70-10-14

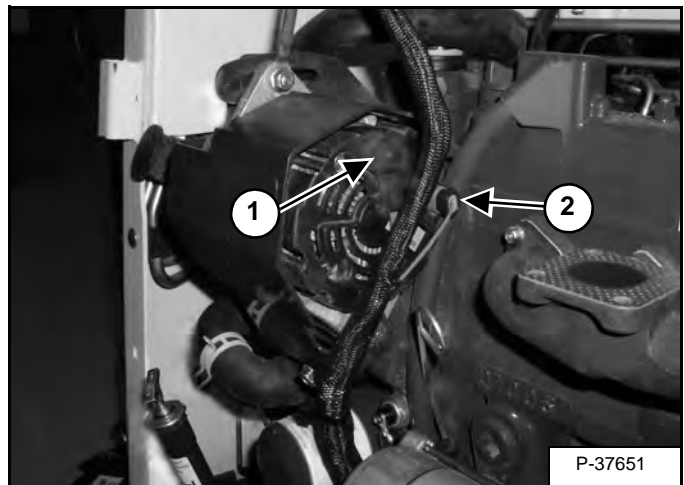

Remove the positive (+) wires (Item 1) [Figure 70-10-14] from the alternator.

Disconnect the electrical connector (Item 2) [Figure 70-10-14] from the alternator.

ENGINE INFORMATION (CONT'D)

Engine Removal And Installation (Cont'd)

Figure 70-10-15

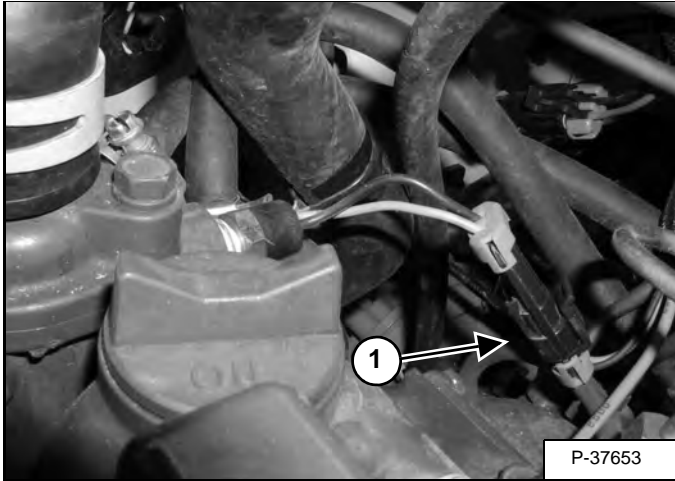

Disconnect the electrical connector (Item 1) [Figure 70-10-15] for the water temperature sender.

Figure 70-10-16

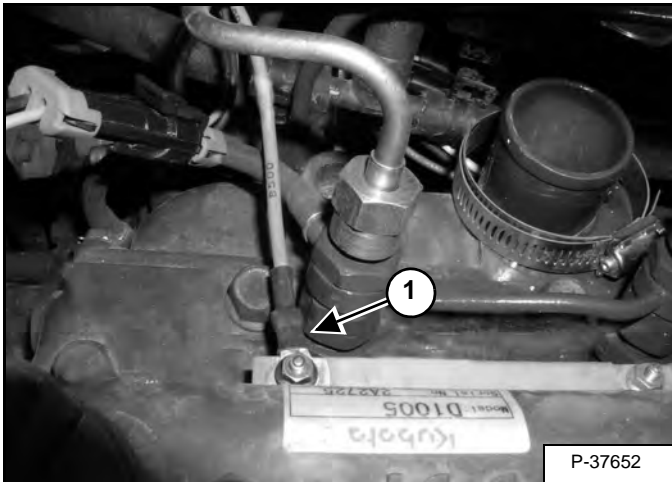

Remove the wire (Item 1) [Figure 70-10-16] from the glow plugs.

Figure 70-10-17

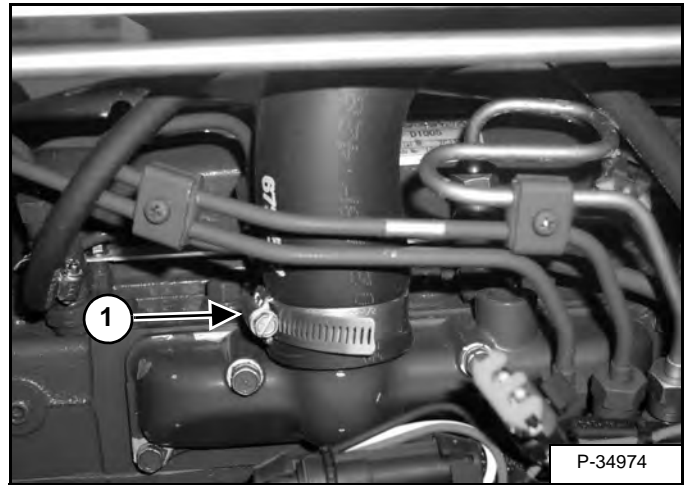

Remove the engine air intake hose (Item 1) [Figure 70-10-17].

ENGINE INFORMATION (CONT'D)

Engine Removal And Installation (Cont'd)

Figure 70-10-18

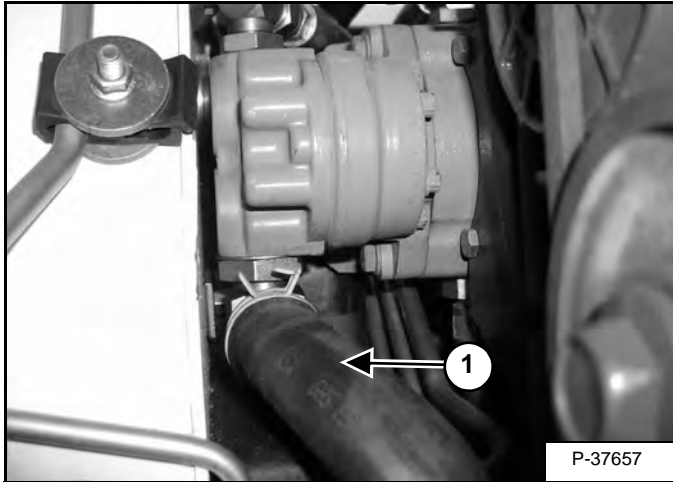

Remove the hydraulic inlet line (Item 1) [Figure 70-10-18] from the hydrostatic pump. Install a plug in the fitting and the hose.

Figure 70-10-19

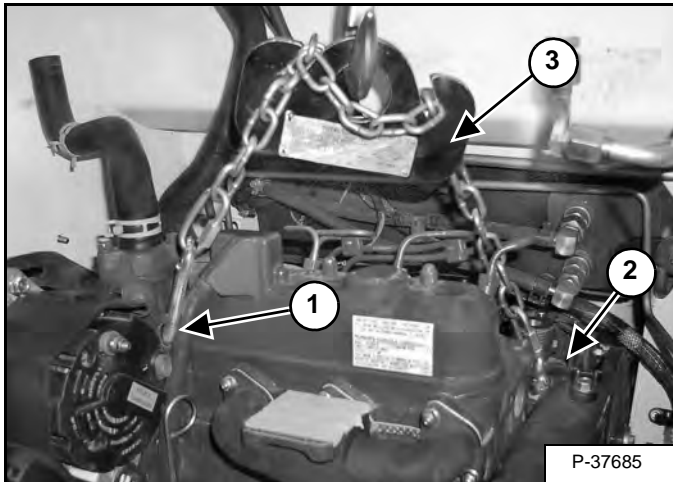

Install a chain with a hook on each end, to the lift eye (Item 1) on the engine, and the provided slot in the engine mounting bracket (Item 2) [Figure 70-10-19].

Use a chain lift device (Item 3) [Figure 70-10-19] and chain hoist to remove the engine and hydrostatic pump.

Lift the engine with the chain hoist until the engine mounts clear the rear lip of the loader frame.

Continue to remove the engine and hydrostatic pump assembly from the loader.

Reverse the removal procedure to install the engine and hydrostatic pump in the loader.

ENGINE INFORMATION (CONT'D)

Engine Mount Replacement

Use the following procedure to install new engine mounts:

Remove the existing mount from the engine. Refer to engine removal and installation for engine mount locations.

Replace all four engine mounts one at each side for the rear and two at each side at the front.

Figure 70-10-20

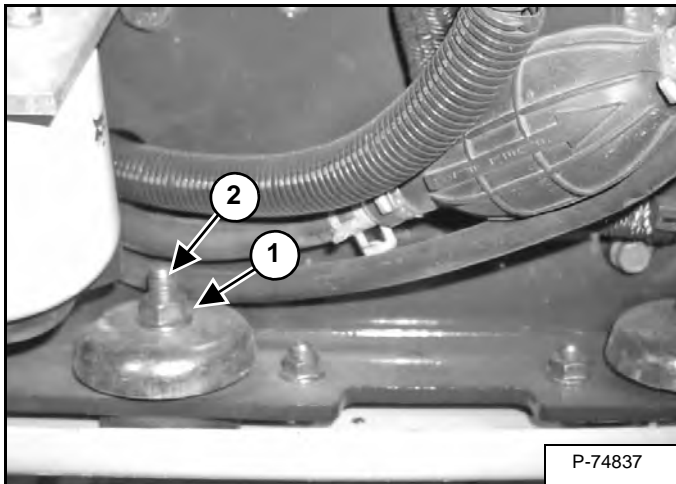

Remove the nut (Item 1) and bolt (Item 2) [Figure 70-10-20] then remove the engine mount.

Figure 70-10-21

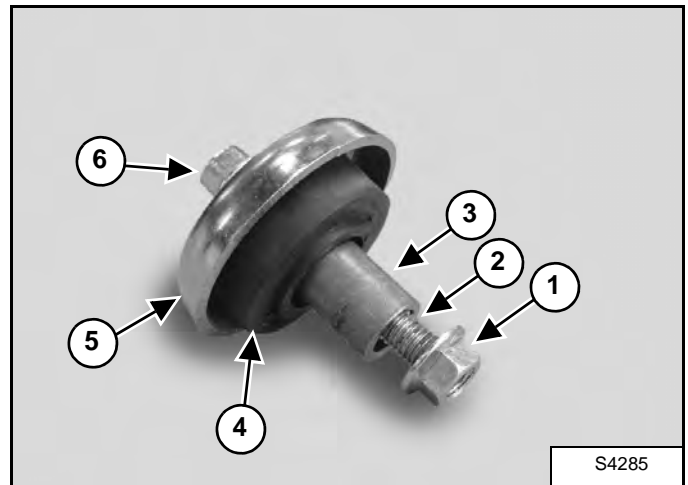

Use the parts shown to install the new engine mounts [Figure 70-10-21]:

Nut - (Item 1)

Bolt - (Item 2)

Spacer - (Item 3)

Engine Mount - (Item 4)

Snubber Cup - (Item 5)

Bolt - (Item 6)

Tighten the mounting bolt (Item 1) [Figure 70-10-21] to 88 - 95 N•m (65 - 70 ft-lb) torque.

ENGINE INFORMATION (CONT'D)

Compression - Checking

The tool listed will be needed to do the following procedure:

MEL10630B- Engine Compression Test Kit
MEL1352- Compression Adapter

Figure 70-10-22

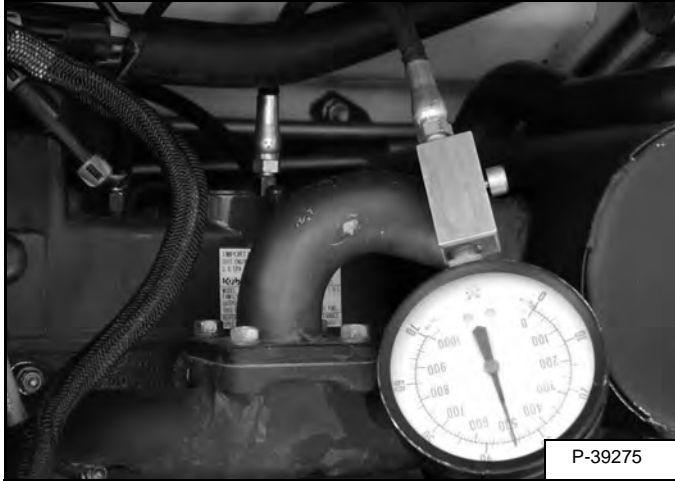

Remove one of the glow plugs from the engine, install the compression adapter in the glow plug hole, and connect the compression gauge on the adapter **[Figure 70-10-22]**.

Disconnect the fuel solenoid and crank the engine with the starter at 200 - 300 rpm. Run the test for each cylinder two times at 5 - 10 seconds each time and take the average reading.

The correct compression for the engine is with no more than 10% difference between the cylinders.

ENGINE SPEED CONTROL

Removal And Installation

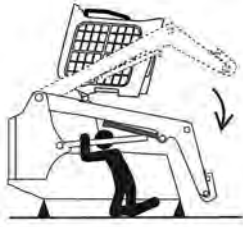

P-90328

AVOID DEATH

- Disconnecting or loosening any hydraulic tubeline, hose, fitting, component or a part failure can cause lift arms to drop.
- Keep out of this area when lift arms are raised unless supported by an approved lift arm support. Replace if damaged.

D-1009-0409



Never work on a machine with the lift arms up unless the lift arms are secured by an approved lift arm support device. Failure to use an approved lift arm support device can allow the lift arms or attachment to fall and cause injury or death.

W-2059-0598

Install jackstands under the rear of the loader. (See Procedure on Page 10-10-1.)

Raise the lift arms and install the lift arm support device. (See Installing on Page 10-20-1.)

Raise the operator cab. (See Raising on Page 10-30-2.)

Remove the center shield and left steering lever panel. (See Control Shield And Steering Lever Panels Removal And Installation on Page 50-90-1.)

Figure 70-20-1

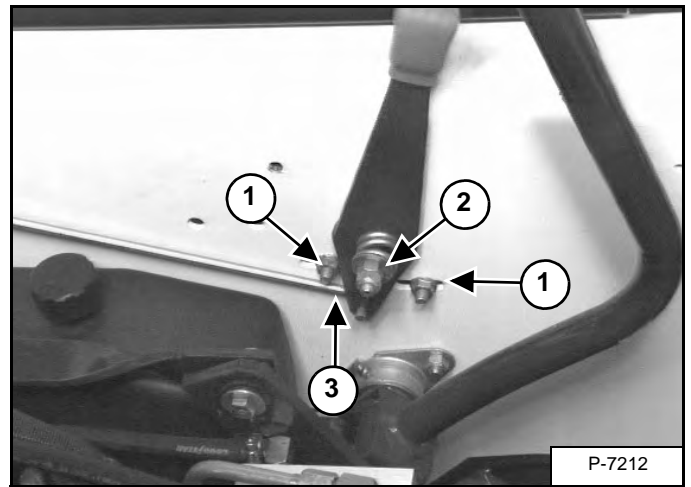

Mark the position of the two adjustment bolts and nuts (Item 1) [Figure 70-20-1] for installation purposes.

Move the bolts as needed to adjust the engine speed.

Remove the mounting bolt and nut (Item 2) [Figure 70-20-1], and the tension spring from the speed control mounting bracket.

Remove the lever and fiber washer between the lever and the fender.

Installation: Tighten the mounting bolt until the speed control lever moves forward and backward at a comfortable tension.

Remove the speed control rod (Item 3) [Figure 70-20-1] from the lever.

Figure 70-20-2

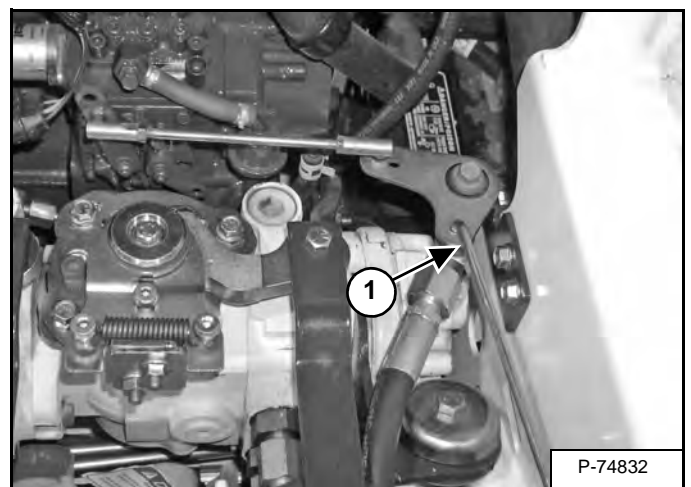

Lift the rod (Item 1) [Figure 70-20-2] to remove the speed control rod from the lever.



Bobcat®

MUFFLER

Removal And Installation

Open the rear door.

Figure 70-30-1

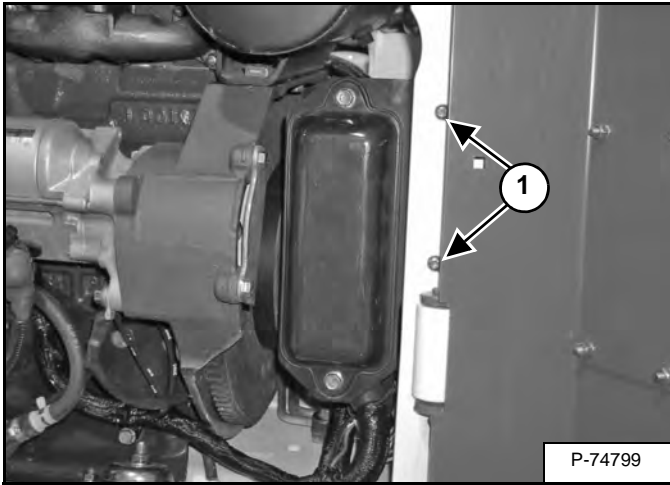

Remove the bolts (Item 1) [Figure 70-30-1] from the fuse panel bracket. Set the bracket aside to gain access to the muffler bolts.

Figure 70-30-2

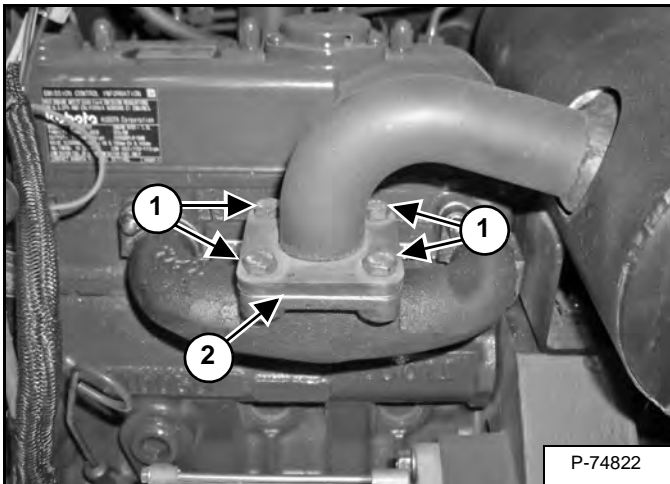

Remove the bolts (Item 1) [Figure 70-30-2] from the muffler flange.

Installation: Tighten the bolts to 23,5 - 27,5 N•m (17.4 - 20.3 ft-lb) torque.

Installation: Use a new gasket (Item 2) [Figure 70-30-2] between the exhaust manifold and the muffler flange.

Figure 70-30-3

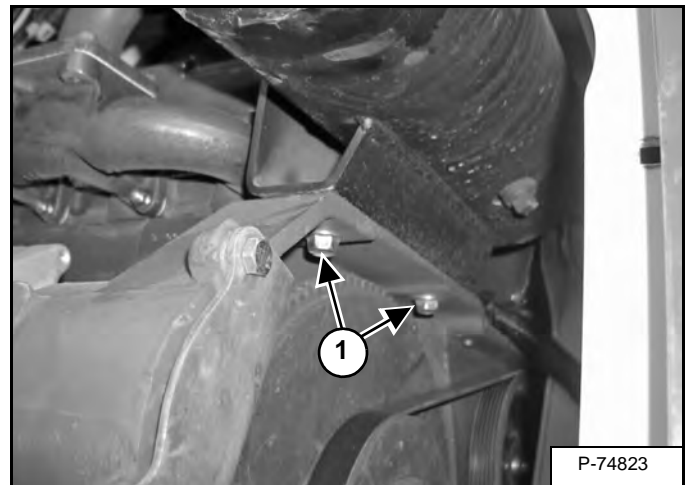

Remove the two bolts (Item 1) [Figure 70-30-3] from the muffler mounting bracket.

Remove the muffler.



Bobcat®

AIR CLEANER

Housing Removal And Installation

Figure 70-40-1

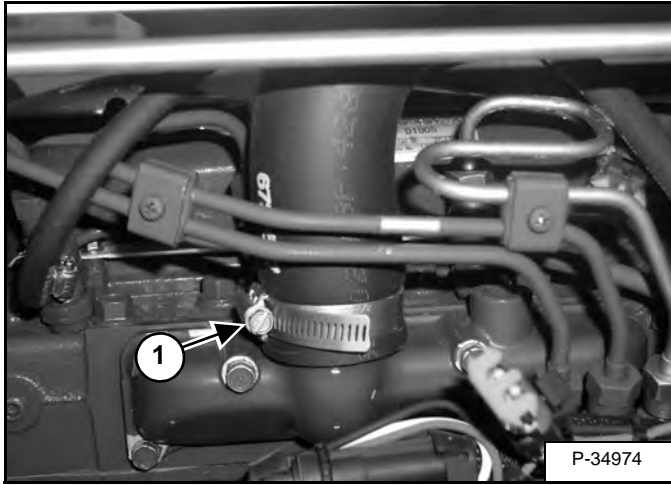

Loosen the clamp (Item 1) [Figure 70-40-1] from the intake manifold hose.

Remove the hose from the intake manifold.

Figure 70-40-2

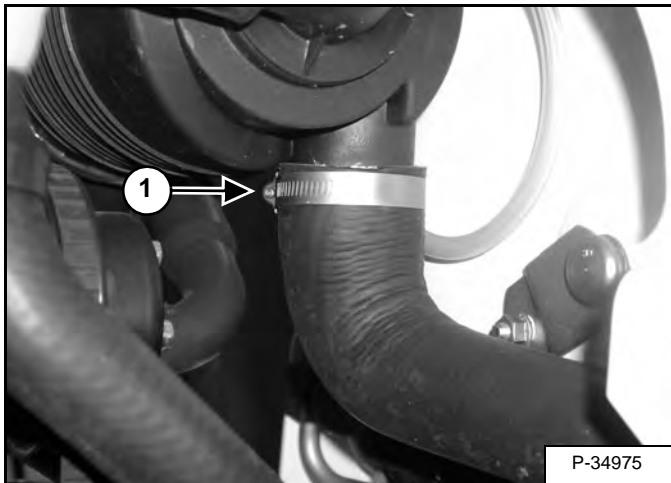

Loosen the clamp (Item 1) [Figure 70-40-2] from the air cleaner hose and remove the hose.

Figure 70-40-3

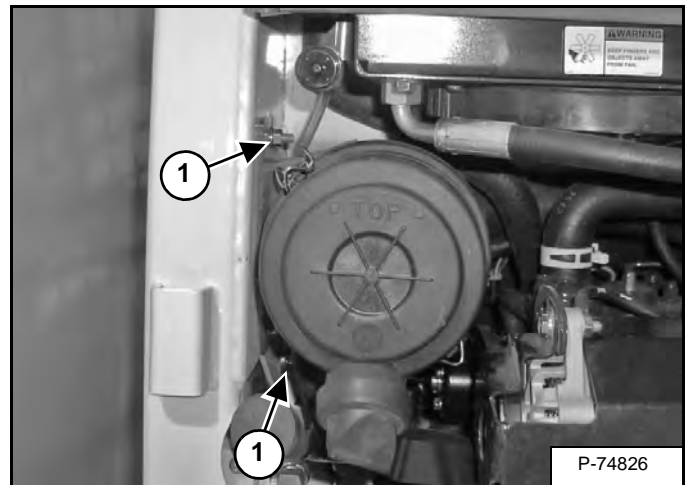

Remove the two nuts (Item 1) [Figure 70-40-3] located in the air cleaner housing mounting bracket.

Figure 70-40-4

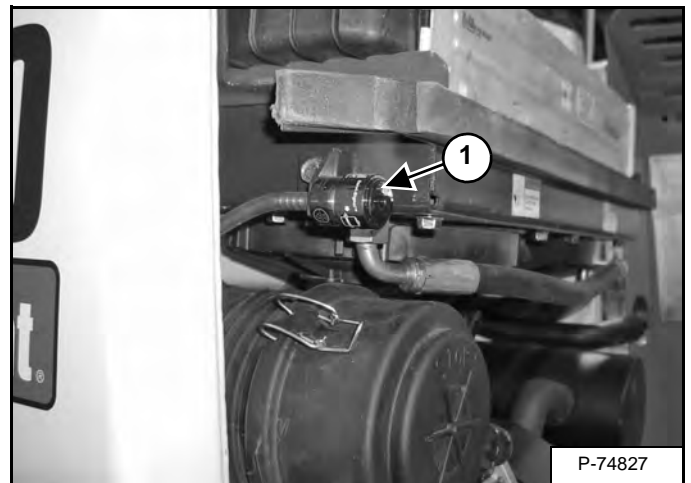

Remove the condition indicator (Item 1) [Figure 70-40-4] from the fitting.

Remove the air cleaner housing from the loader.



Bobcat®

ENGINE COOLING SYSTEM

Radiator Removal And Installation

Open the rear door.

Drain the coolant from the engine. (See Removing And Replacing Coolant on Page 10-90-3.)

WARNING

AVOID INJURY OR DEATH

Always clean up spilled fuel or oil. Keep heat, flames, sparks or lighted tobacco away from fuel and oil. Failure to use care around combustibles can cause explosion or fire.

W-2103-0508

IMPORTANT

Always keep hydraulic and hydrostatic parts clean. Clean outside of all assemblies before beginning repairs. Use plugs and caps to cover open ports. Dirt can quickly damage the system.

I-2173-0598

Figure 70-50-1

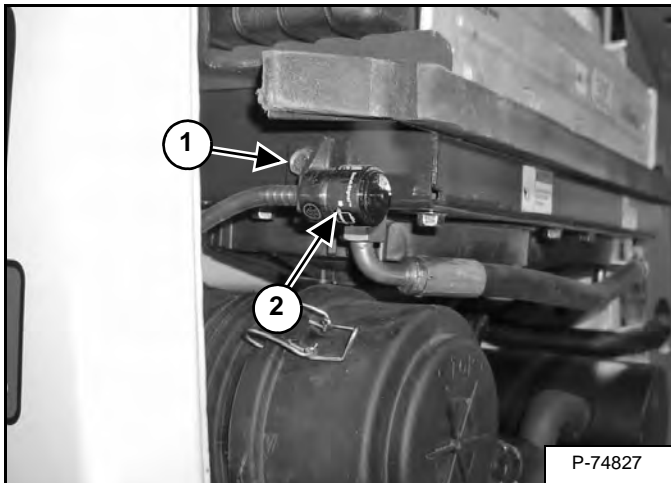

Remove the bolt (Item 1) and move the air cleaner indicator (Item 2) [Figure 70-50-1] out of the way.

Figure 70-50-2

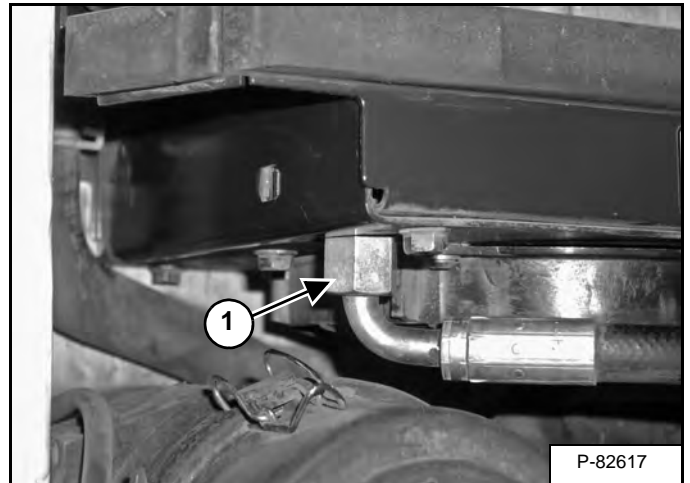

Disconnect the hose (Item 1) [Figure 70-50-2] from the left side of the oil cooler.

Figure 70-50-3

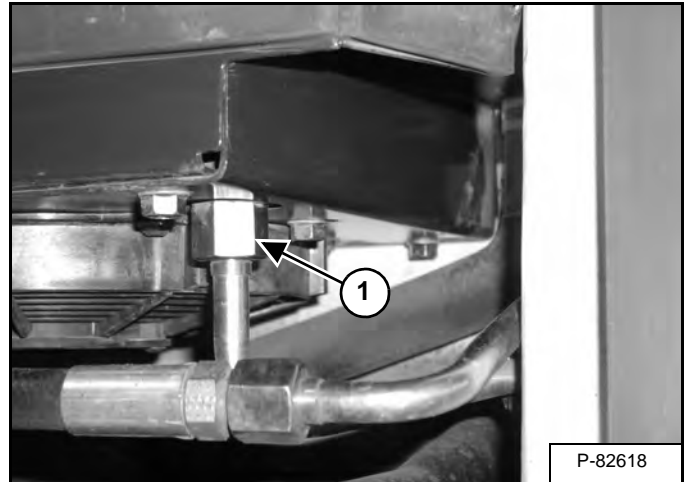

Disconnect the tubeline (Item 1) [Figure 70-50-3] from the right side of the oil cooler.

Figure 70-50-4

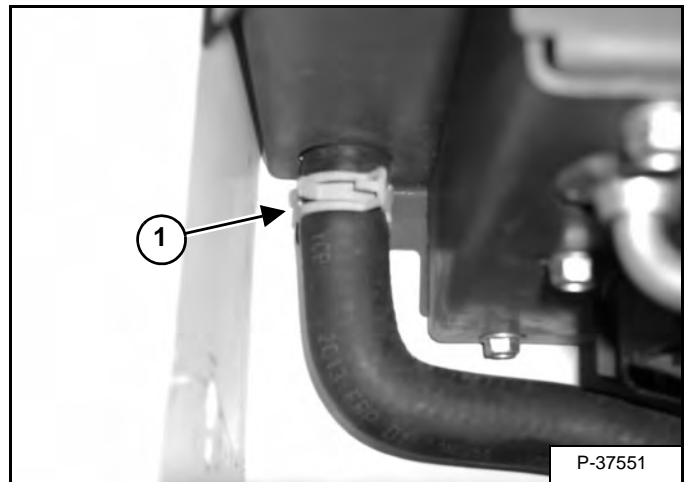

Remove the outlet hose (Item 1) [Figure 70-50-4] from the radiator.

ENGINE COOLING SYSTEM (CONT'D)

Radiator Removal And Installation (Cont'd)

Figure 70-50-5

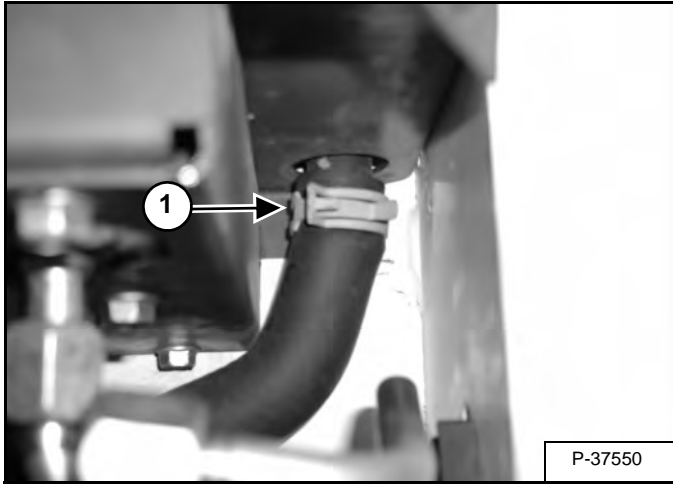

Remove the inlet hose (Item 1) [Figure 70-50-5] from the radiator.

Figure 70-50-6

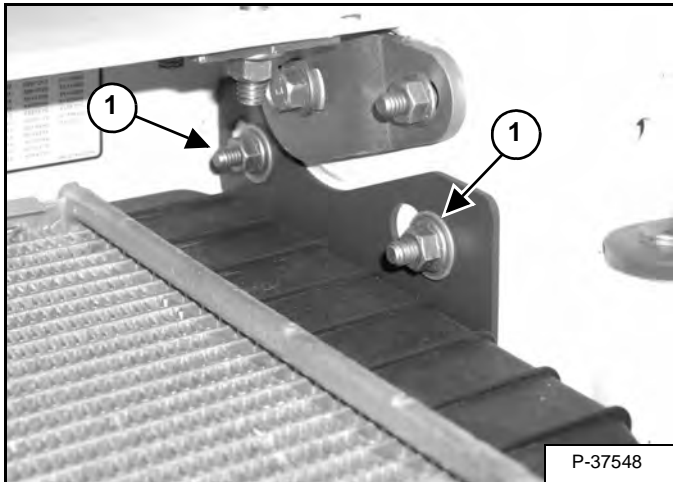

Loosen the right side mounting nuts (Item 1) [Figure 70-50-6].

Figure 70-50-7

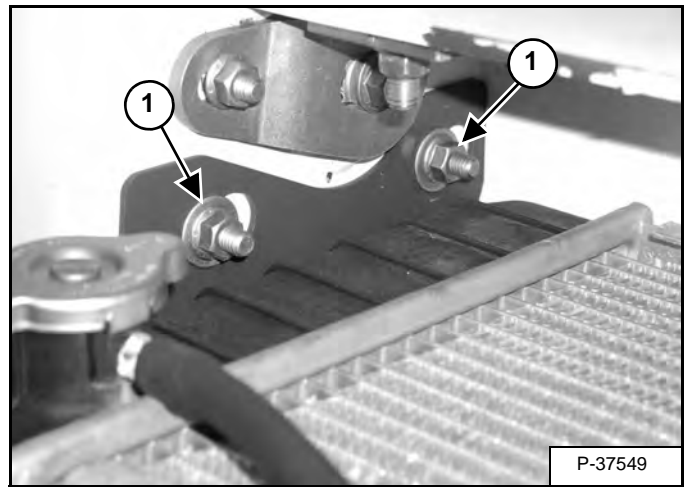

Loosen the left side mounting nuts (Item 1) [Figure 70-50-7].

Slide the radiator to the rear to remove the carriage bolts from the frame. Remove the radiator assembly.

Reverse the procedure to install the radiator assembly.

Remove the radiator assembly from the loader.

Figure 70-50-8

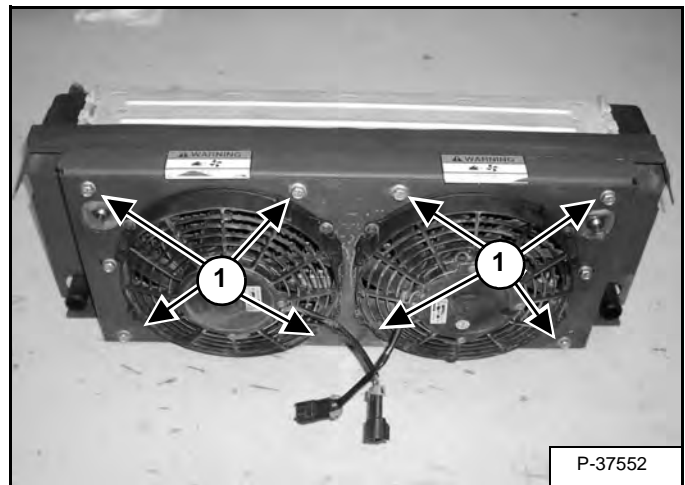

Remove the bolts (Item 1) [Figure 70-50-8] to remove the radiator from the assembly.

ENGINE COOLING SYSTEM (CONT'D)

Fan Removal And Installation

Open the rear door.

Figure 70-50-9

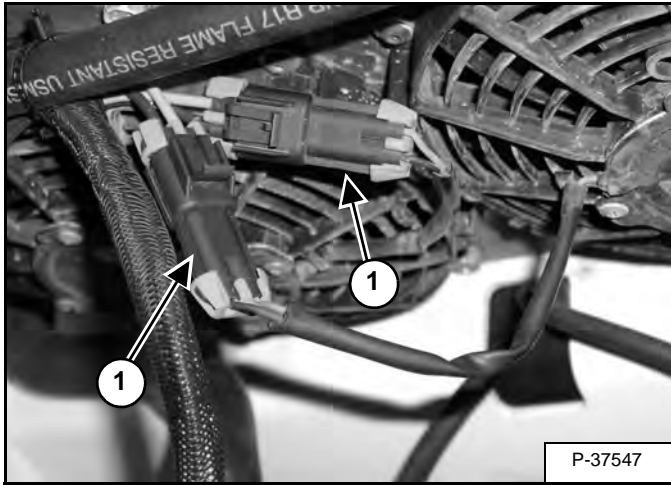

Remove the cooling fan connectors (Item 1) [Figure 70-50-9] from the loader harness.

Figure 70-50-10

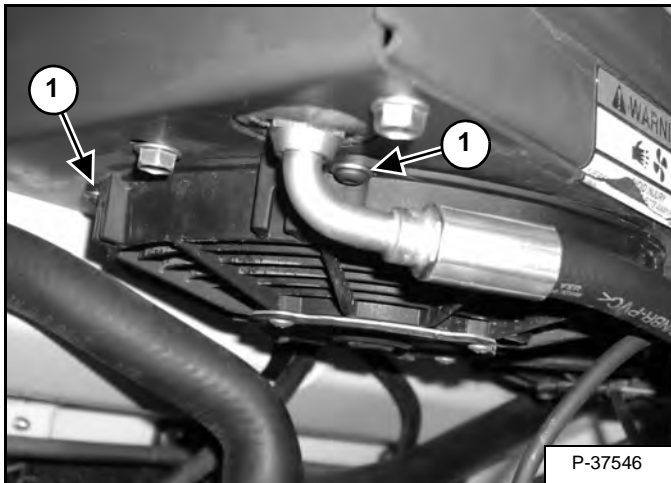

Remove the mounting screws (Item 1) [Figure 70-50-10] to remove the fan.

Water Pump Removal And Installation

Drain the coolant from the engine. (See Removing And Replacing Coolant on Page 10-90-3.)

Remove the alternator. (See Removal And Installation on Page 60-30-5.)

Figure 70-50-11

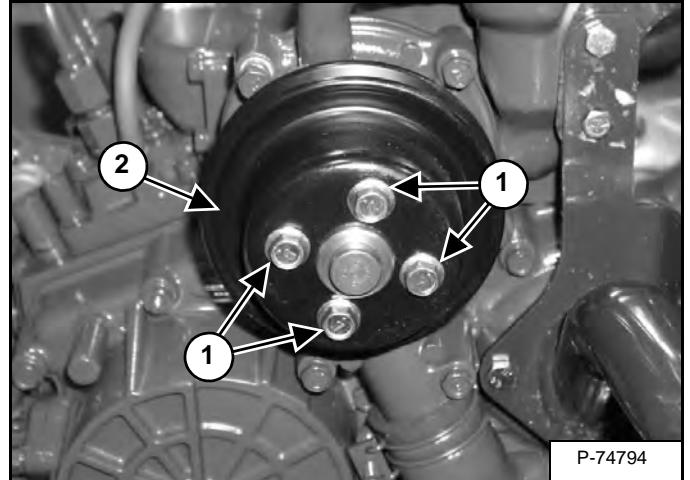

Remove the four mounting bolts (Item 1) from the belt pulley (Item 2) [Figure 70-50-11] and remove the pulley from the water pump.

Figure 70-50-12

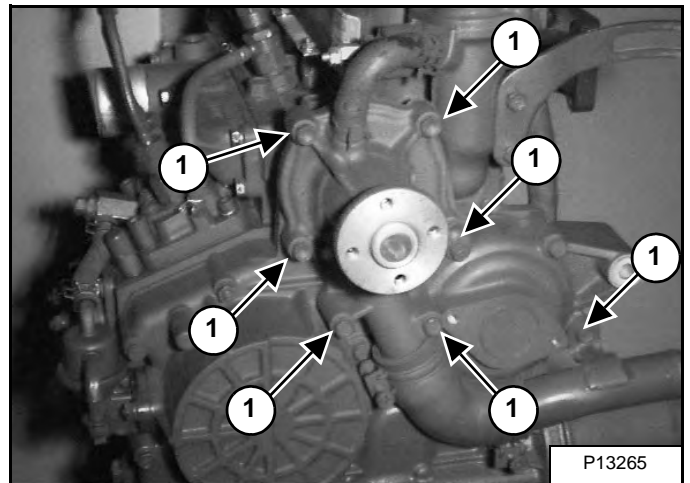

Remove the seven mounting bolts (Item 1) [Figure 70-50-12] from the water pump.

NOTE: The bolts may vary in length. Keep the bolts in their original location.

Installation: Tighten the mounting bolts to 9,8 - 11,3 N•m (87 - 100 in-lb) torque.

Remove the water pump from the engine.

Installation: Always use a new gasket when installing the water pump.

ENGINE COOLING SYSTEM (CONT'D)

Water Pump Disassembly And Assembly

Figure 70-50-13

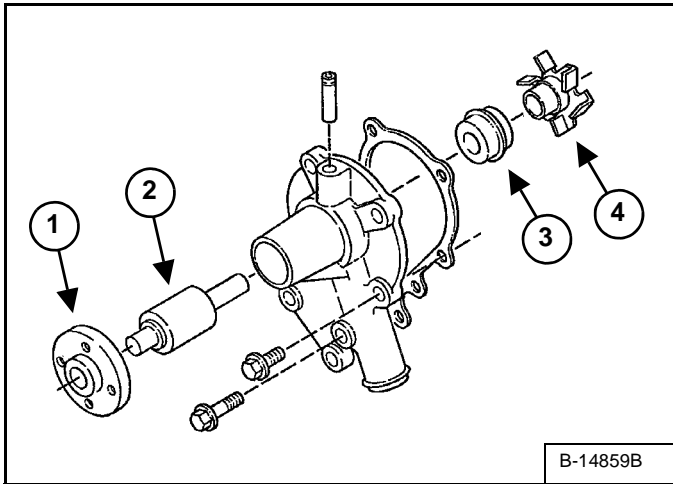

Put the water pump in a vise.

Remove the pulley (Item 1) and press the shaft (Item 2) [Figure 70-50-13] out of the pulley side of the water pump.

Remove the seal (Item 1) and impeller (Item 2) [Figure 70-50-13].

Assembly: Install a new seal when assembling the water pump.

Thermostat Housing Removal And Installation

Figure 70-50-14

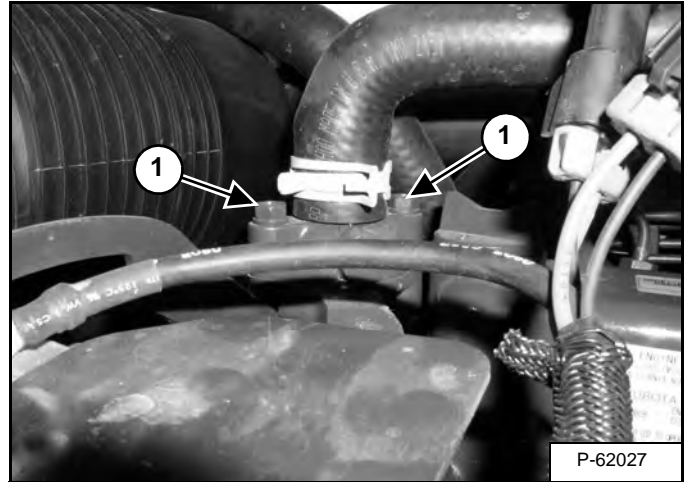

Remove the bolts (Item 1) [Figure 70-50-14] from the thermostat housing.

Installation: Tighten the bolts to 9,8 - 11,3 N•m (87 - 100 in-lb) torque.

Figure 70-50-15

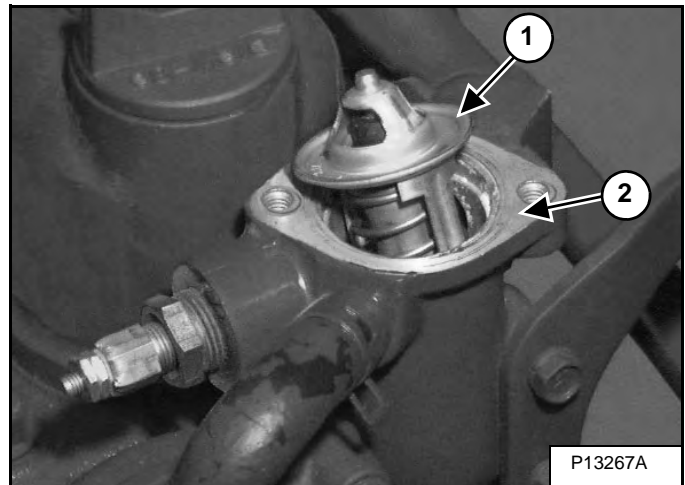

Remove thermostat (Item 1) [Figure 70-50-15] and replace if necessary.

Always replace the thermostat gasket (Item 2) [Figure 70-50-15].

LUBRICATION SYSTEM

Oil Pan Removal And Installation

Remove the engine and hydrostatic pump assembly from the loader. (See Engine Removal And Installation on Page 70-10-9.)

The engine will have to be on an engine stand or suspended in the air safely to remove the oil pan.

Figure 70-60-1

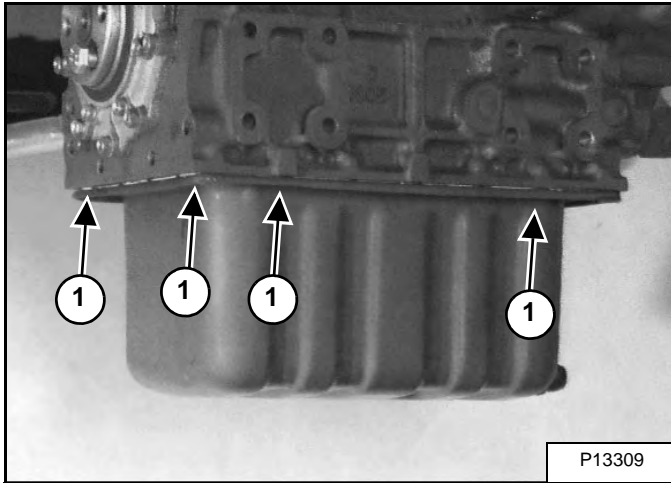

Remove the oil pan mounting bolts (Item 1) [Figure 70-60-1] and remove the oil pan.

Installation: Tighten pan mounting bolts to 9,8 - 11,3 N•m (87 - 100 in-lb) torque, in a diagonal order from the center.

Figure 70-60-2

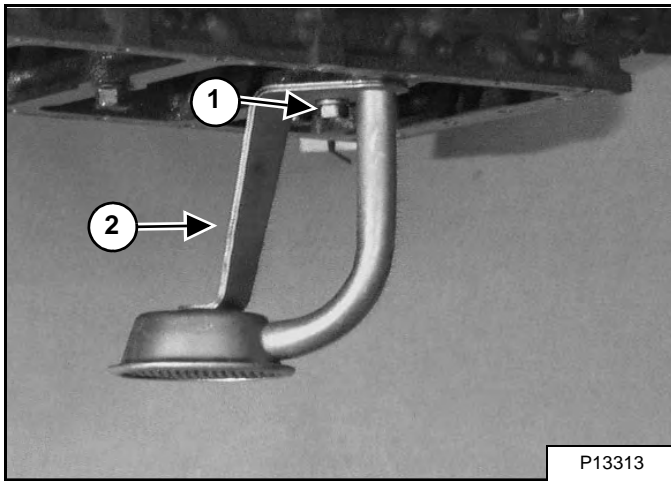

Remove the mounting bolt (Item 1) and remove the oil pickup tube (Item 2) [Figure 70-60-2].

Installation: Tighten the oil pickup tube mount bolt to 23,1 - 27,1 N•m (17 - 20 ft-lb) torque.

Figure 70-60-3

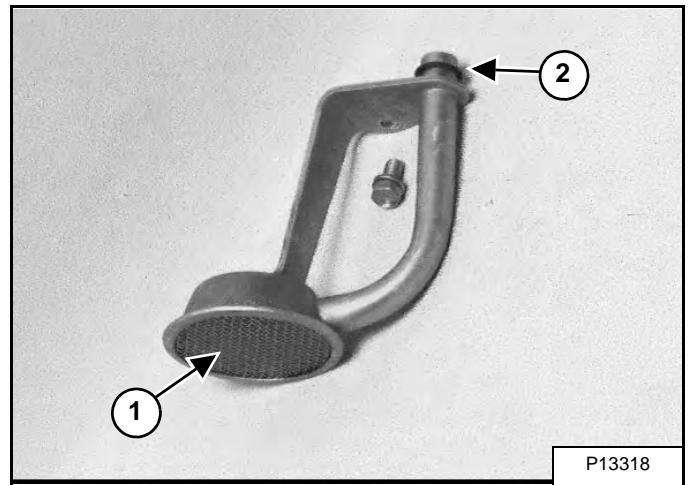

Clean the oil pickup tube screen (Item 1) [Figure 70-60-3].

Check the O-ring (Item 2) [Figure 70-60-3] and replace if worn.

Use care not to damage O-ring when installing the oil pickup tube.

NOTE: Clean the surface of the oil pan and the block thoroughly. And apply a new liquid gasket to the oil pan before installing.

LUBRICATION SYSTEM (CONT'D)

Oil Pump Removal And Installation

Remove timing gearcase cover. (See Timing Gearcase Cover Removal And Installation on Page 70-100-1.)

Figure 70-60-4

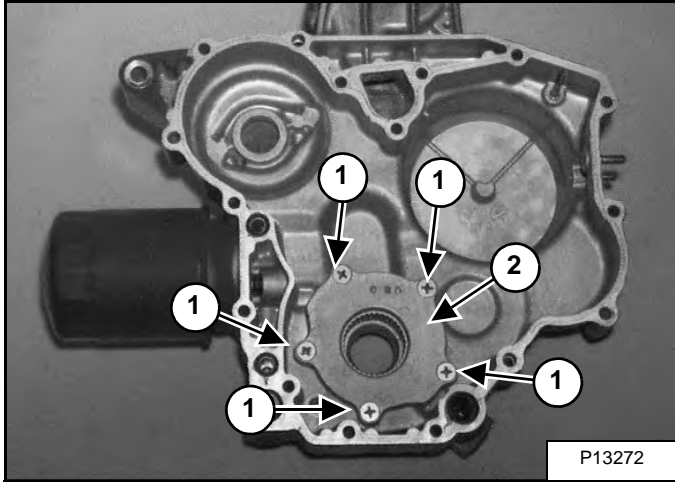

Remove the mounting bolts (Item 1) [Figure 70-60-4] from the back of the oil pump.

Installation: Tighten the mounting bolts to 7,9 - 12,8 N•m (70 - 113 in-lb) torque.

Remove the rear cover (Item 2) [Figure 70-60-4].

Figure 70-60-5

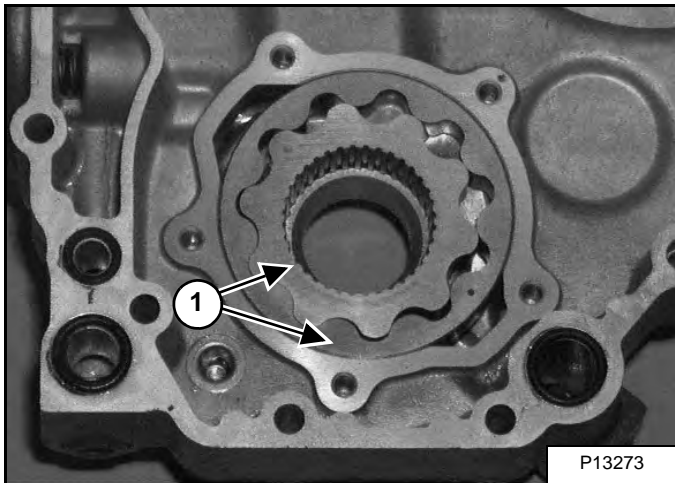

Remove the oil pump rotor assembly (Item 1) [Figure 70-60-5] and check for wear.

Figure 70-60-6

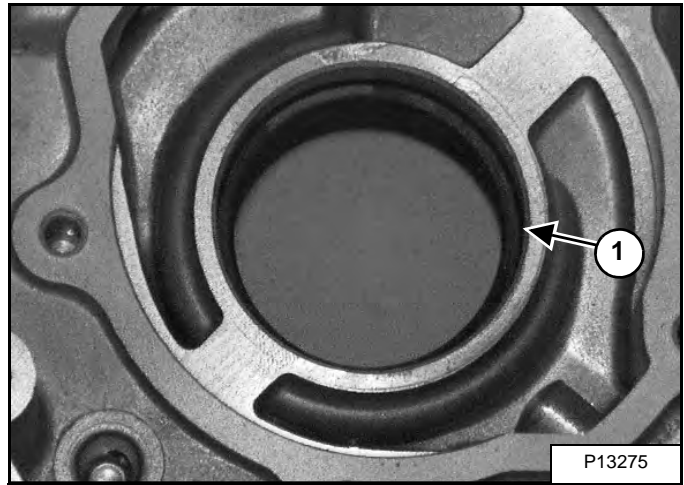

Replace the front crankshaft seal (Item 1) [Figure 70-60-6].

Oil Pump Inspection

Figure 70-60-7

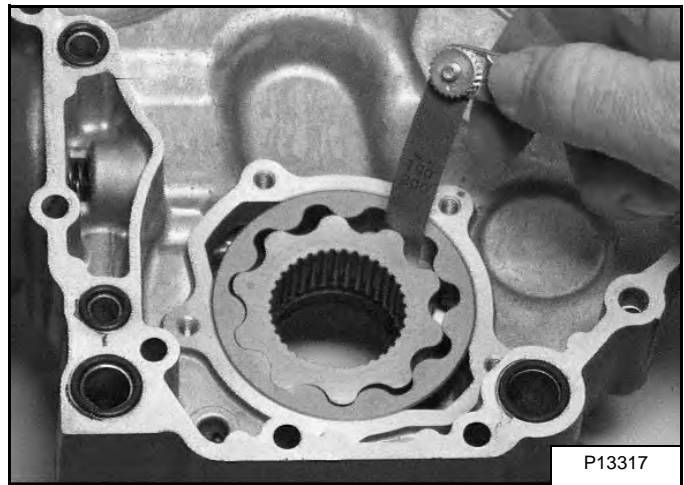

Measure the clearance between the lobes of the inner rotor and the outer rotor with a feeler gauge [Figure 70-60-7].

The clearance between inner rotor and outer rotor should be 0,06 - 0,18 mm (0.0024 - 0.0071 in).

LUBRICATION SYSTEM (CONT'D)

Oil Pump Inspection (Cont'd)

Figure 70-60-8

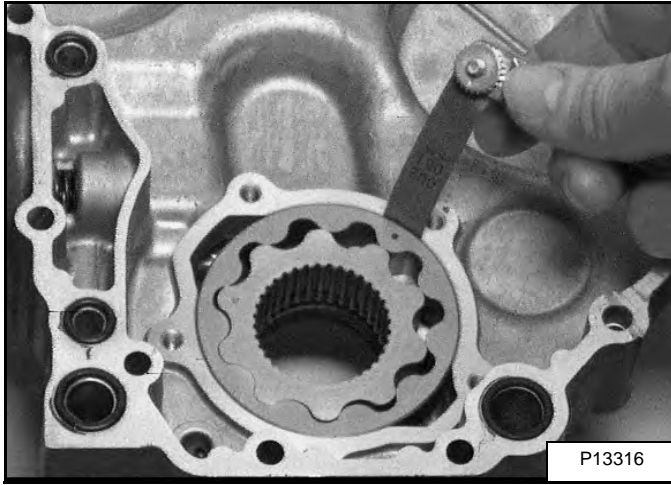

Measure the clearance between the outer rotor and the pump body with a feeler gauge [Figure 70-60-8].

The clearance between outer rotor and the pump body is 0,100 - 0,180 mm (0.0039 - 0.0071 in).

Figure 70-60-9

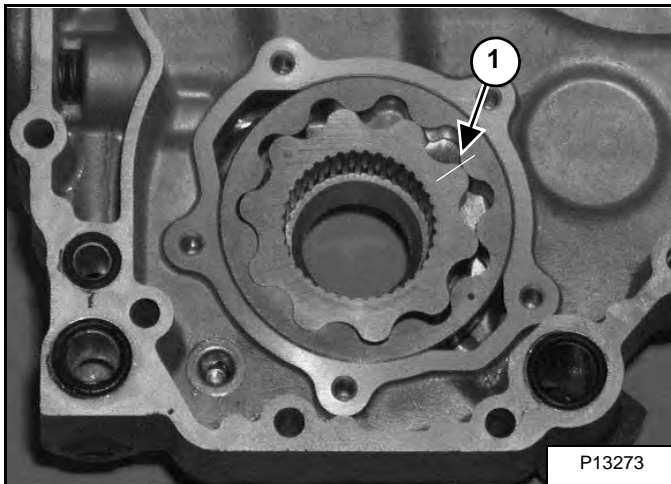

Put a strip of plastic gauge (Item 1) [Figure 70-60-9] onto the rotor face.

Figure 70-60-10

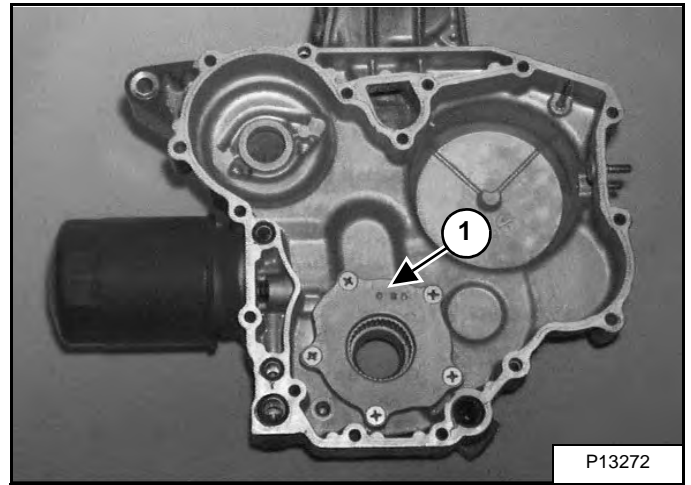

Install the oil pump cover (Item 1) [Figure 70-60-10] and tighten the cover bolts to 7,9 - 12,8 N•m (70 - 113 in-lb) torque.

Figure 70-60-11

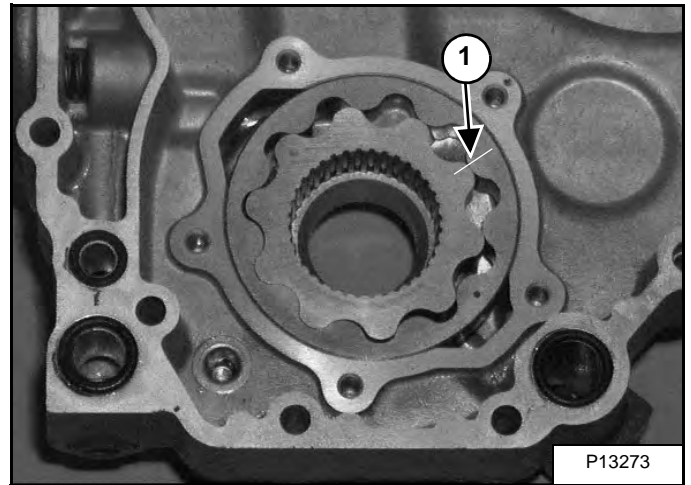

Remove the cover and measure the width of the pressed plastic gauge (Item 1) [Figure 70-60-11].

The end clearance between the inner rotor and the oil pump cover should be 0,025 - 0,075 mm (0.0010 - 0.0029 in).

LUBRICATION SYSTEM (CONT'D)

Engine Oil Pressure - Testing

Remove the oil pressure sender.

Figure 70-60-12

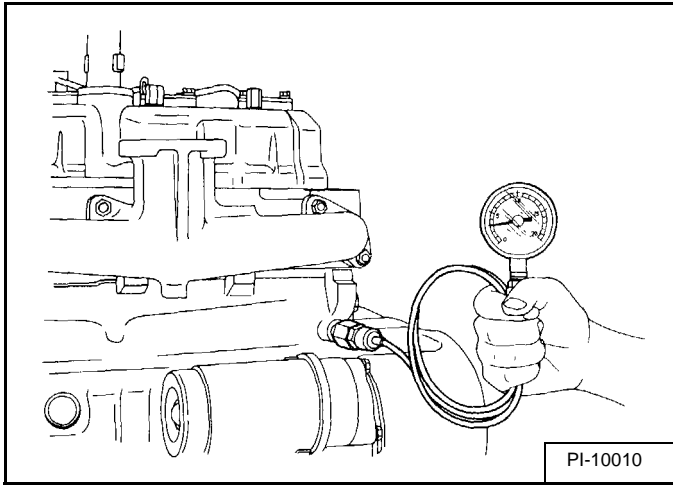

Install a pressure gauge [Figure 70-60-12].

Start the engine and run until it is at operating temperature.

If the oil pressure is less than the allowable limit, check the following items:

- * Engine Oil Level Low
- * Oil Pump Defective
- * Oil Galley Plugged
- * Oil Strainer Plugged
- * Excessive Clearance at the Rod And Main Bearings
- * Oil Pump Relief Valve Stuck

At Idle Speed Allowable Limit	48 kPa (0,50 bar) (7 psi)
At Rated Speed Allowable Limit	193 - 441 kPa (1,96 - 4,41 bar) (28 - 64 psi)

FUEL SYSTEM

Fuel Camshaft Removal And Installation

Remove the timing gearcase cover. (See Timing Gearcase Cover Removal And Installation on Page 70-100-1.)

Remove the idler gear. (See Idler Gear And Shaft Removal And Installation on Page 70-100-3.)

Figure 70-70-1

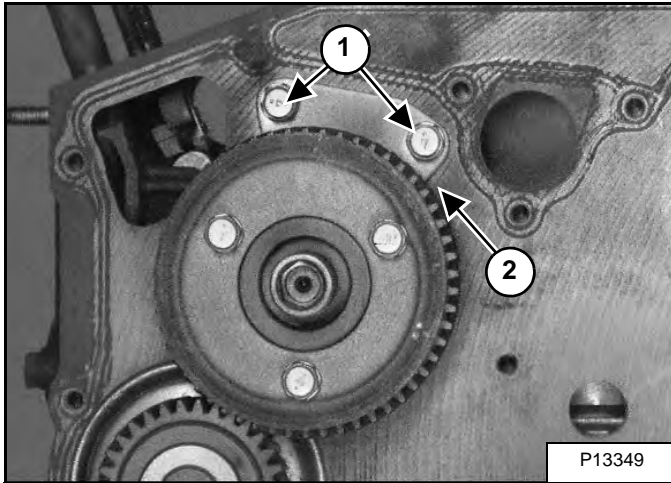

Remove the two mounting bolts (Item 1) and remove the injection pump shaft stop (Item 2) [Figure 70-70-1].

Installation: Tighten the mounting bolts to 9,8 - 11,3 N•m (89 - 100 in-lb) torque.

Remove the injection pump shaft from the block.

Figure 70-70-2

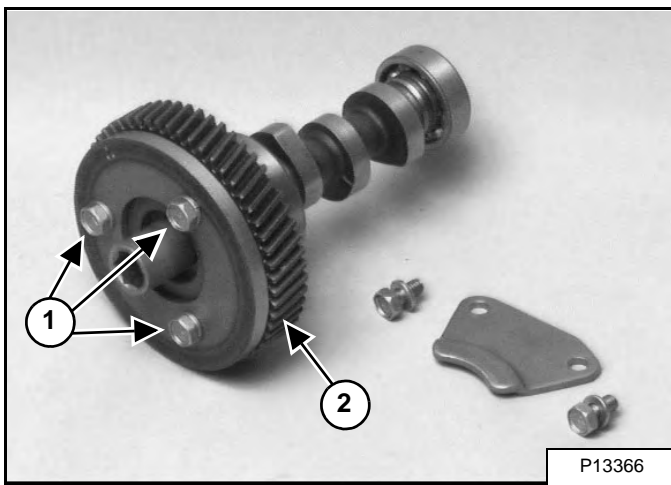

Remove the three mounting bolts (Item 1) from the injection pump gear (Item 2) [Figure 70-70-2].

Installation: Tighten the mounting bolts to 9,8 - 11,3 mm (89 - 100 in-lb) torque.

Figure 70-70-3

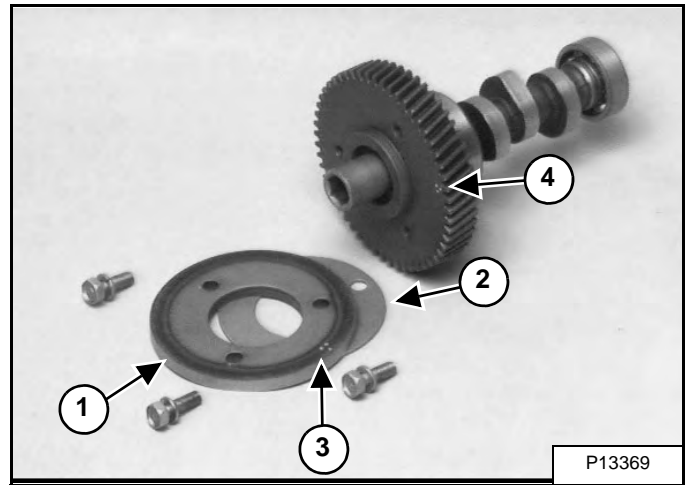

Remove the fuel cam (Item 1) and the cam washer (Item 2) [Figure 70-70-3] from the injection pump shaft gear.

Installation: When installing the injection pump shaft and washer to the injection pump shaft gear align the timing marks (Item 3) on the injection pump shaft with the timing marks (Item 4) [Figure 70-70-3] on the injection pump shaft gear.

FUEL SYSTEM (CONT'D)

Fuel Camshaft Shaft Removal And Installation (Cont'd)

Figure 70-70-4

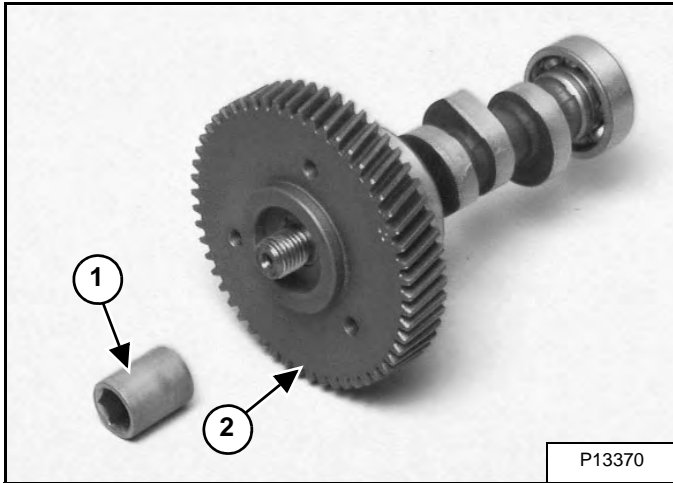

Remove the nut (Item 1) [Figure 70-70-4] from the injection pump shaft.

Installation: Tighten the nut to 58,3 - 69,2 N•m (43 - 51 ft-lb) torque.

Remove the injection pump gear (Item 2) [Figure 70-70-4] from the injection pump shaft.

Figure 70-70-5

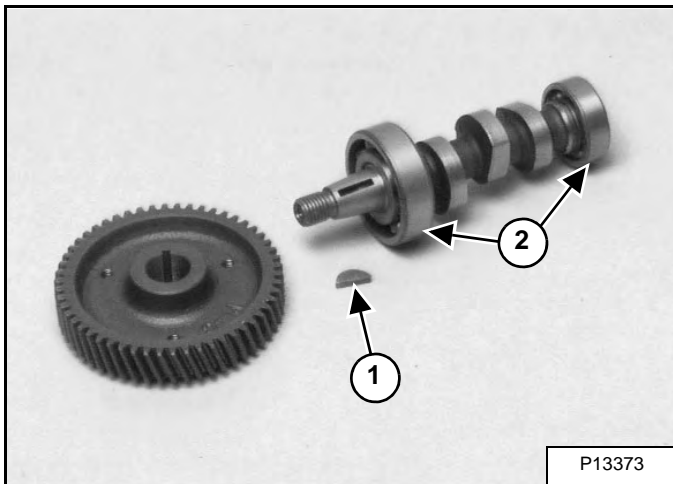

Inspect the key (Item 1) [Figure 70-70-5] and the key ways in the gear and on the shaft for wear and replace if needed.

Inspect the bearings (Item 2) [Figure 70-70-5] for wear and replace as needed.

FUEL SYSTEM (CONT'D)

Governor Shaft Removal And Installation

Figure 70-70-6

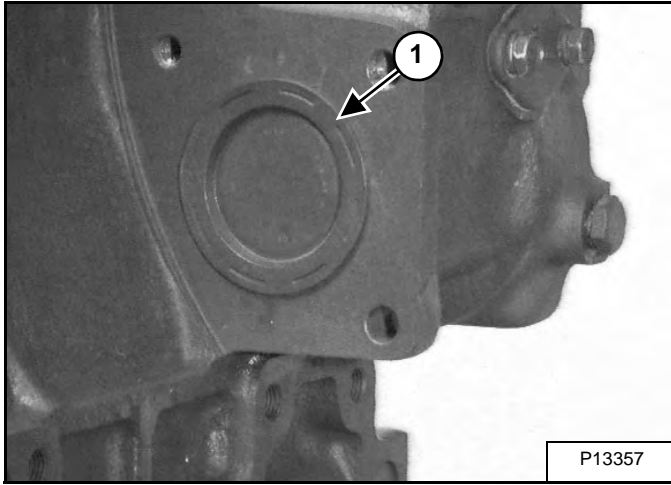

Remove the fuel camshaft plug (Item 1) [Figure 70-70-6] from the block.

Figure 70-70-7

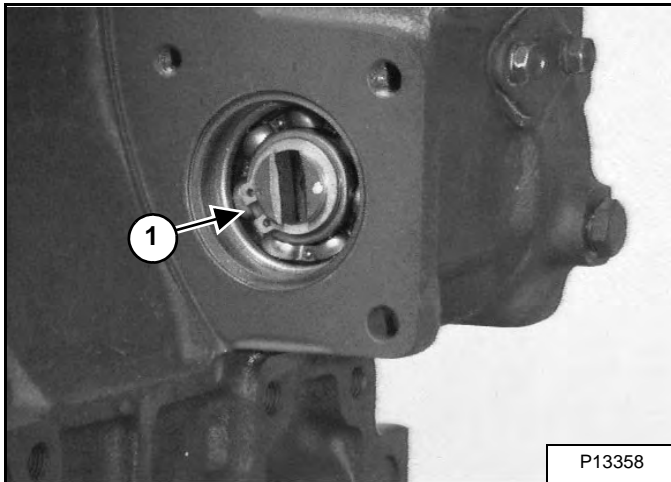

Remove the snap ring (Item 1) [Figure 70-70-7] from the governor shaft.

Figure 70-70-8

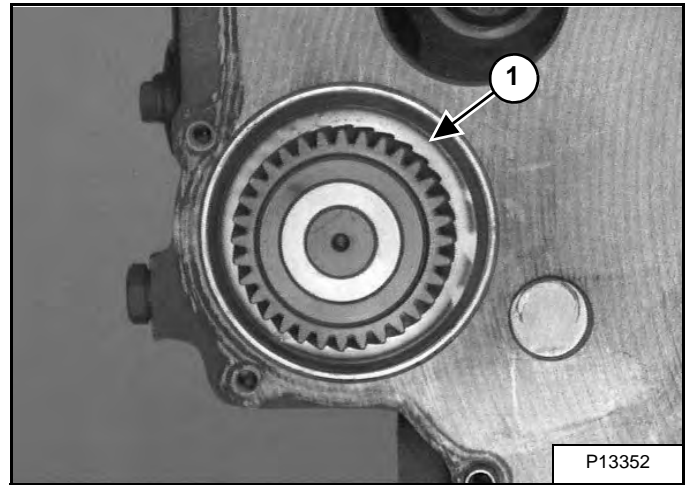

Remove the governor shaft assembly (Item 1) [Figure 70-70-8] from the front of the block.

Figure 70-70-9

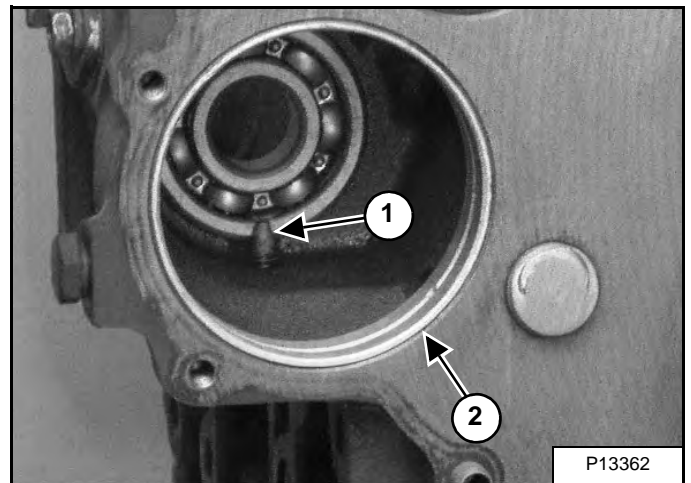

NOTE: The set screw (Item 1) [Figure 70-70-9] must be removed to remove the rear governor shaft bearing.

Inspect the governor gear bushing (Item 2) [Figure 70-70-9] and replace if needed.

FUEL SYSTEM (CONT'D)

Governor Shaft Removal And Installation (Cont'd)

Figure 70-70-10

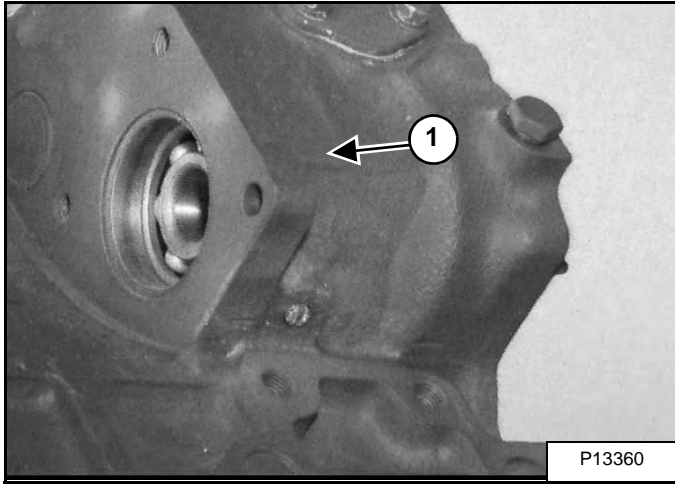

Remove the set screw (Item 1) [Figure 70-70-10] from the block.

Figure 70-70-11

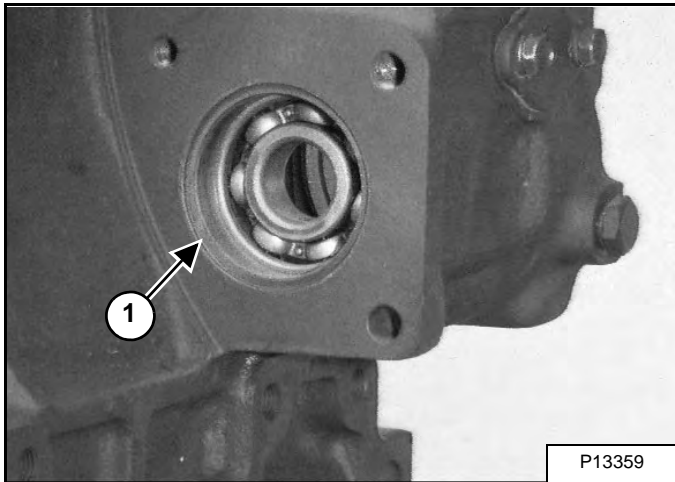

Remove the rear bearing (Item 1) [Figure 70-70-11].

NOTE: The bearing must be driven out toward the front of the block.

Figure 70-70-12

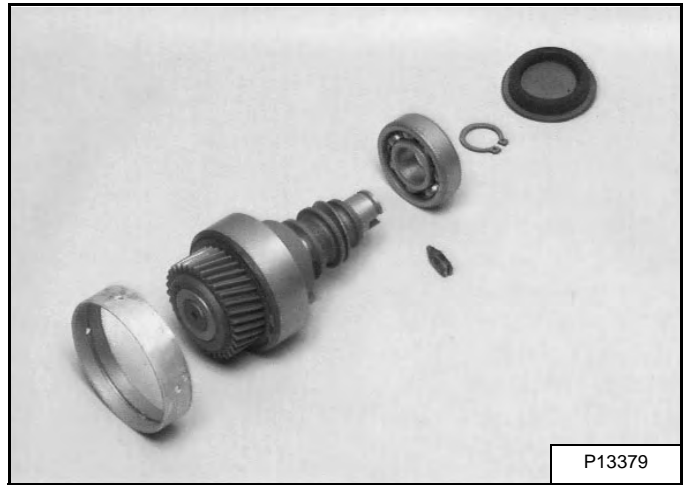

Inspect the parts from the governor shaft for wear and replace if needed [Figure 70-70-12].

Figure 70-70-13

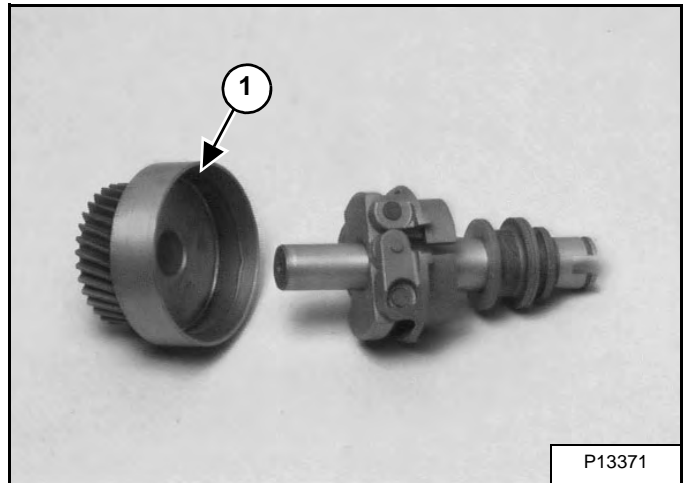

Remove the governor gear holder and governor gear (Item 1) [Figure 70-70-13] from the governor shaft.

FUEL SYSTEM (CONT'D)

Governor Shaft Removal And Installation (Cont'd)

Figure 70-70-14

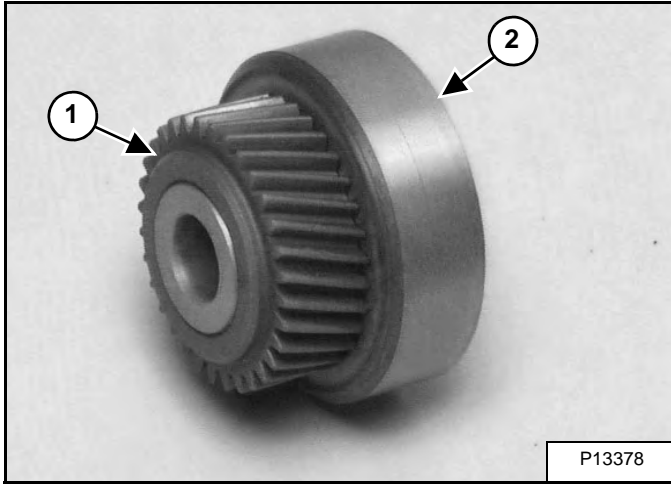

Remove the governor gear (Item 1) from the gear holder (Item 2) [Figure 70-70-14].

Figure 70-70-15

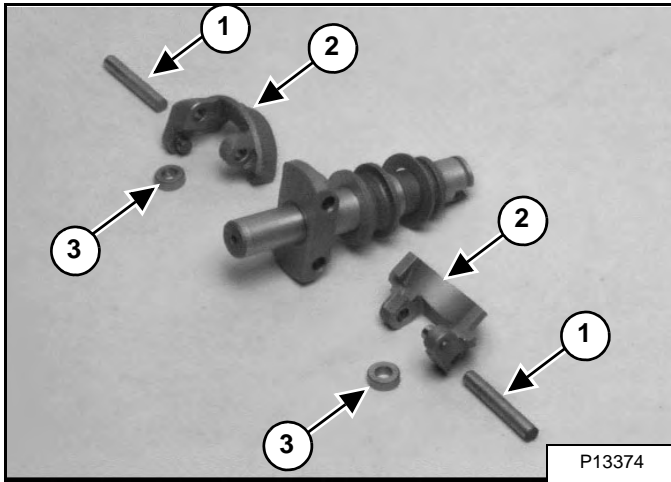

Remove the governor weight shafts (Item 1) from the governor weights (Item 2) [Figure 70-70-15].

Remove the governor weights.

Remove the rollers (Item 3) [Figure 70-70-15] from the governor weights.

Figure 70-70-16

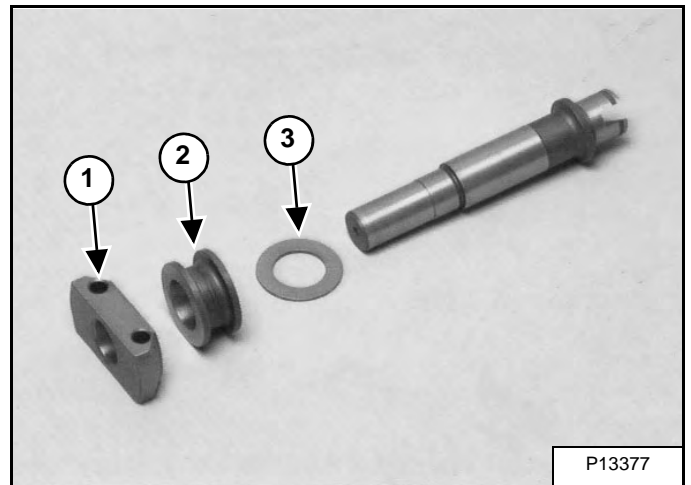

Remove the governor weight holder (Item 1) [Figure 70-70-16] from governor shaft.

Remove the governor sleeve (Item 2) and thrust washer (Item 3) [Figure 70-70-16] from governor shaft.

Inspect all parts and replace if needed.

FUEL SYSTEM (CONT'D)

Governor Fork Lever Removal And Installation

Figure 70-70-17

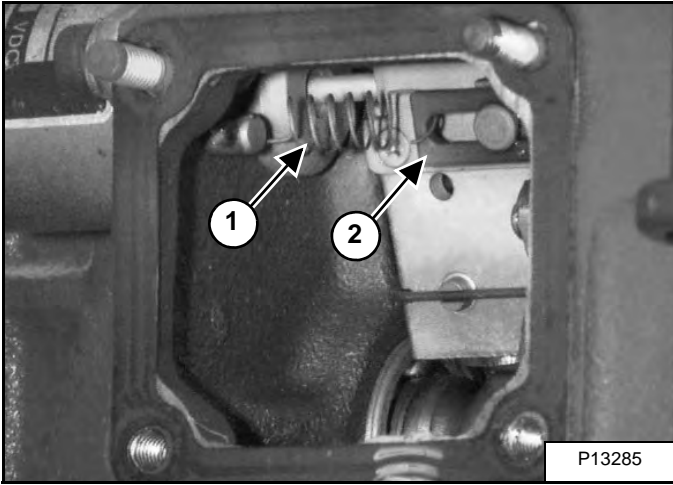

Remove the speed control plate. (See Removal And Installation on Page 70-20-1.)

Remove the fuel injection pump. (See Fuel Injection Pump Removal And Installation on Page 70-70-9.)

Remove the start spring (Item 1) from the fork compensation lever (Item 2) [Figure 70-70-17].

Figure 70-70-18

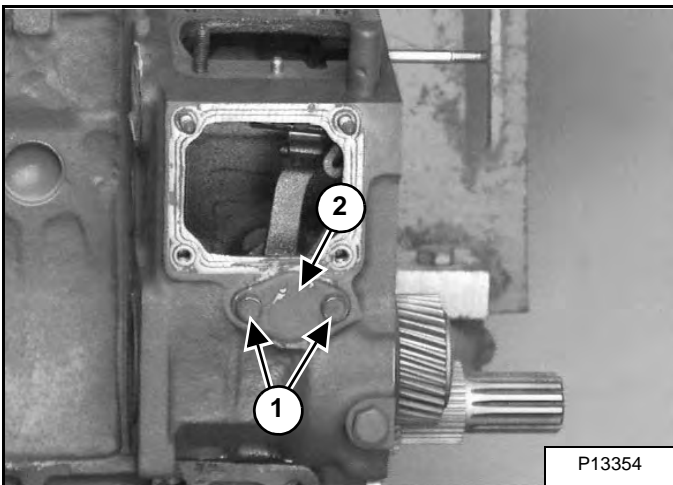

Remove the two mounting bolts (Item 1) from fork lever shaft cover (Item 2) [Figure 70-70-18].

Figure 70-70-19

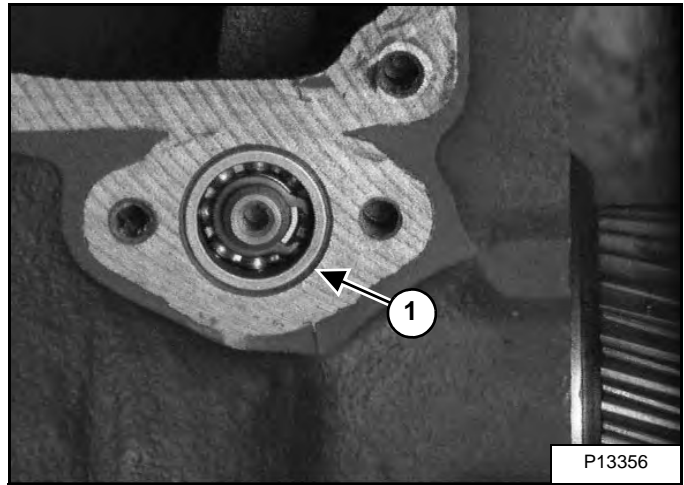

Remove the fork lever cover and gasket from the block.

Remove the governor fork lever collar (Item 1) [Figure 70-70-19] from the block.

Figure 70-70-20

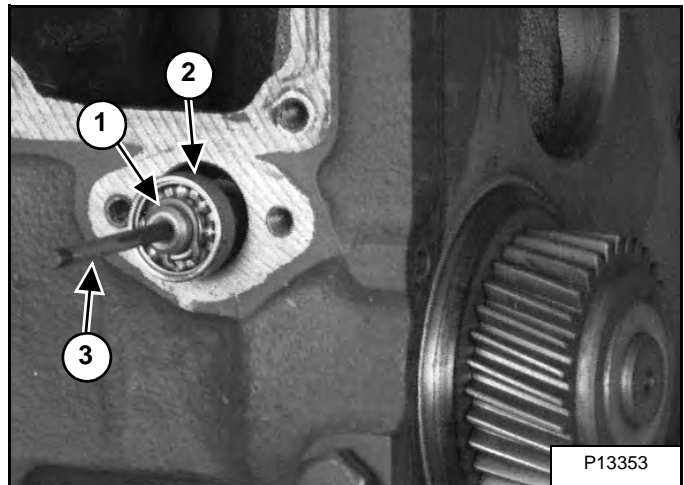

Remove the governor fork lever shaft (Item 1) and outer bearing (Item 2), using a metric tap (Item 3) [Figure 70-70-20] screwed into the threads of the fork lever shaft for leverage.

Remove the fork compensating lever and fork lever from the block.

FUEL SYSTEM (CONT'D)

Governor Fork Lever Removal And Installation (Cont'd)

Figure 70-70-21

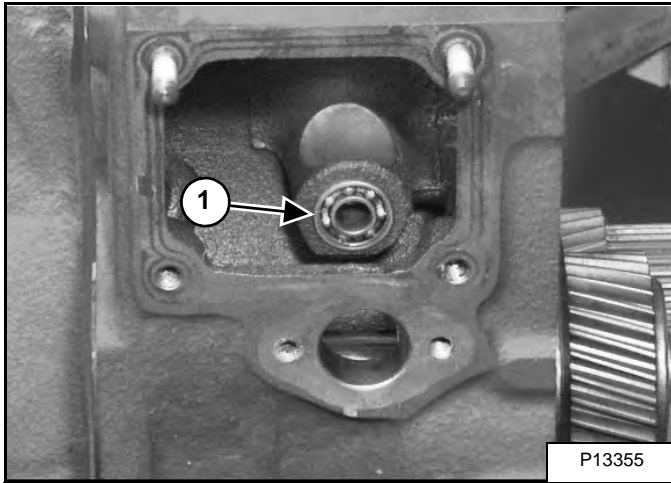

Remove the inside governor fork lever bearing (Item 1) [Figure 70-70-21].

Figure 70-70-22

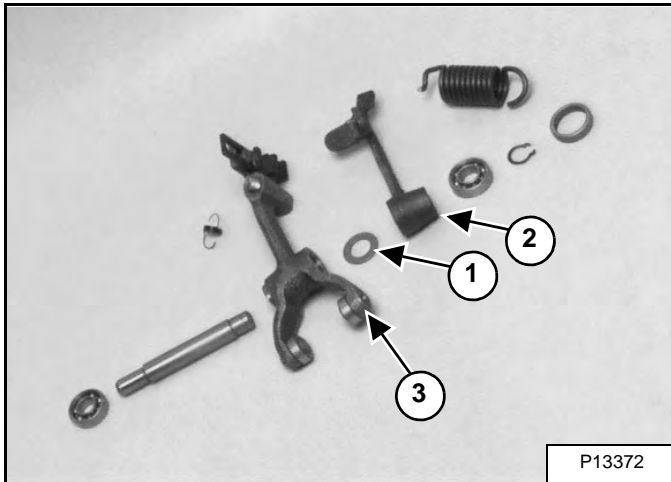

Inspect the parts for wear and replace as needed [Figure 70-70-22].

NOTE: The washer (Item 1) goes between the fork lever (Item 2) and the fork compensating lever (Item 3) when being installed [Figure 70-70-22].

FUEL SYSTEM (CONT'D)

Fuel ShutOff Solenoid - Checking

Raise the operator cab. (See Raising on Page 10-30-2.)

Figure 70-70-23

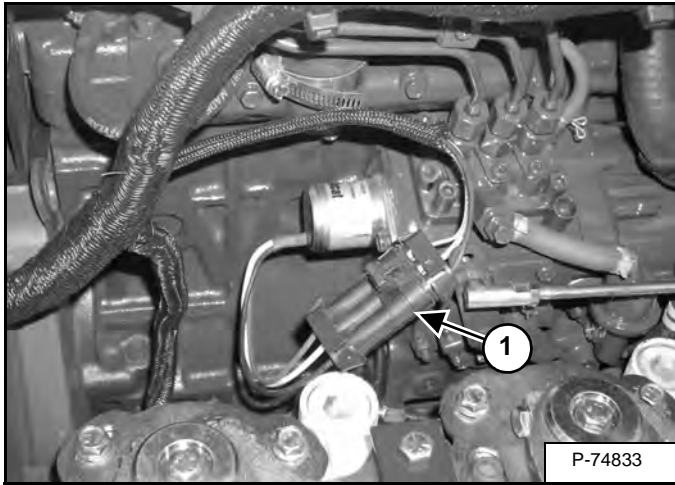

Disconnect the fuel shutoff solenoid electrical connector (Item 1) [Figure 70-70-23] from the main harness.

Use an ohmmeter to check the fuel shutoff solenoid.

Figure 70-70-24

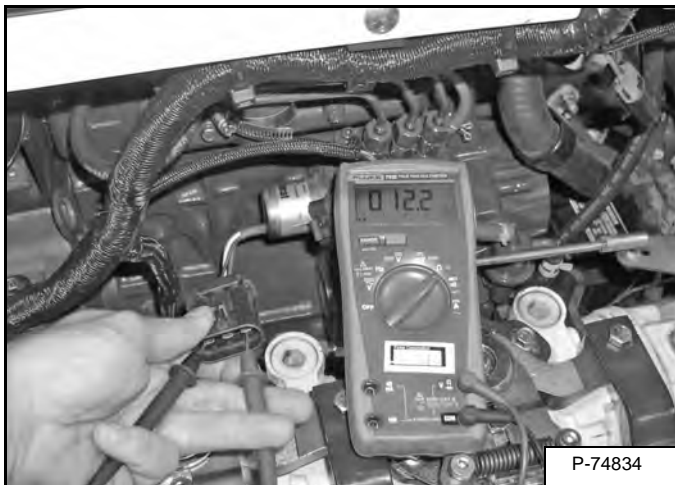

The reading between electrical connector terminal C and terminal A must be between approximately 12.2 ohm [Figure 70-70-24].

The reading between electrical connector terminal C and terminal B must be between approximately 0.7 - 0.8 ohm.

Fuel ShutOff Solenoid Removal And Installation

Raise the operator cab. (See Raising on Page 10-30-2.)

Figure 70-70-25

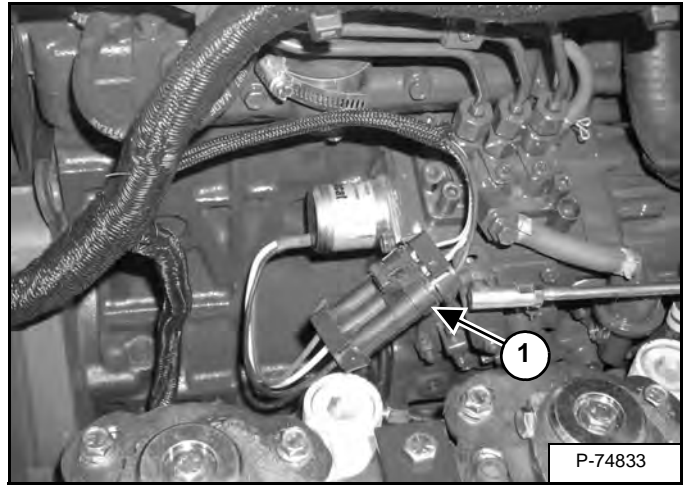

Disconnect the fuel shutoff solenoid electrical connector (Item 1) [Figure 70-70-25] from the main harness.

Figure 70-70-26

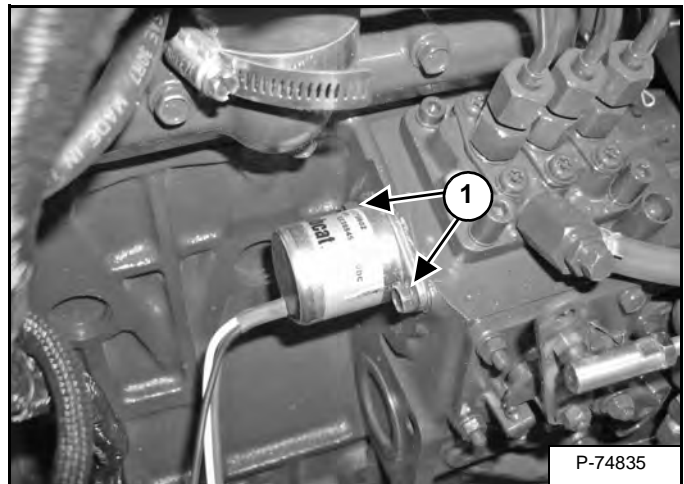

Remove the mounting bolts (Item 1) [Figure 70-70-26] that secure the fuel shutoff solenoid.

Reverse the above procedure to install the fuel shutoff solenoid.

FUEL SYSTEM (CONT'D)

Fuel Injection Pump Removal And Installation

IMPORTANT

Do not attempt to maintain or adjust unless you are trained and have the correct equipment.

I-2028-0289

IMPORTANT

Never steam clean or put cold water on an injection pump while the engine is running or while it is hot. If you do it will cause serious damage to the injection pump.

I-2135-0997

IMPORTANT

Do not bend the high pressure fuel injection tubes when removing or installing them.

I-2029-0289

Thoroughly clean the area around the injection pump.

Use these tools for the following procedure:

MEL1270 - Fuel Line Removal Tool

MEL1271 - Delivery Valve Removal Tool

Figure 70-70-27

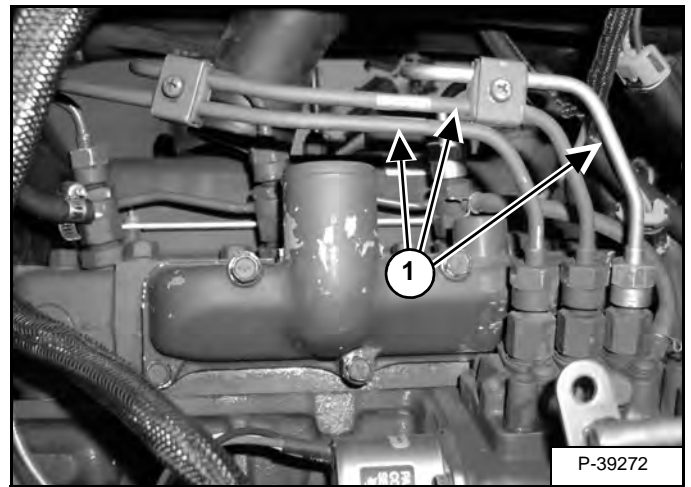

Disconnect the high pressure fuel lines (Item 1) [Figure 70-70-27] from the injection pump and the injectors.

Installation: Tighten the injection pipe retaining nut to 23 - 36 N•m (17 - 26 ft-lb) torque.

Figure 70-70-28

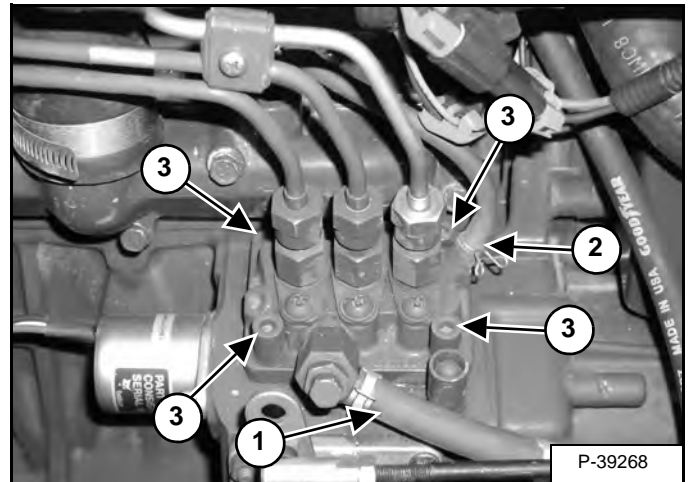

Disconnect the fuel inlet hose (Item 1) and the fuel return hose (Item 2) [Figure 70-70-28].

Remove the four bolts (Item 3) [Figure 70-70-28] from the injection pump.

Installation: Tighten the four nuts to 23 - 27 N•m (17 - 20 ft-lb) torque.

FUEL SYSTEM (CONT'D)

Fuel Injection Pump Removal And Installation (Cont'd)

Figure 70-70-29

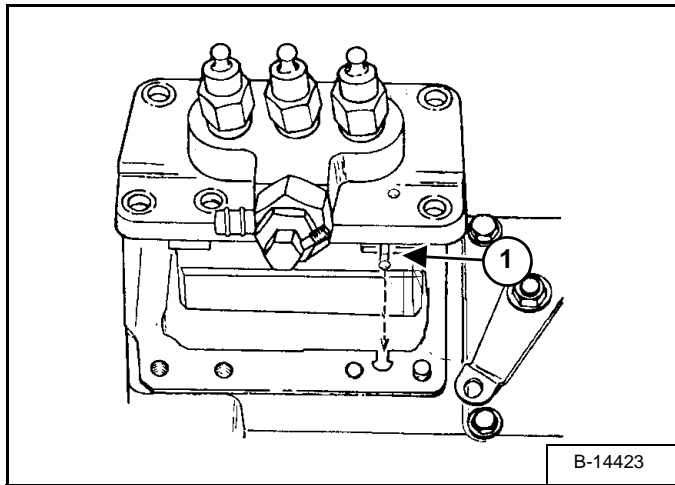

Lift the injection pump while moving it to align the pin (Item 1) [Figure 70-70-29] in the control rack with the slot in the engine block to remove the pump.

Installation: When the injection pump is installed, make sure the pin (Item 1) [Figure 70-70-29] on the control rack is correctly installed in the fork lever. If the slot is not installed correctly, the engine will run over a maximum speed and serious damage can result.

NOTE: Make sure the same number of shims are installed under the injection pump. The shims are used for engine timing.

FUEL SYSTEM (CONT'D)

Fuel Injection Pump Timing

Figure 70-70-30

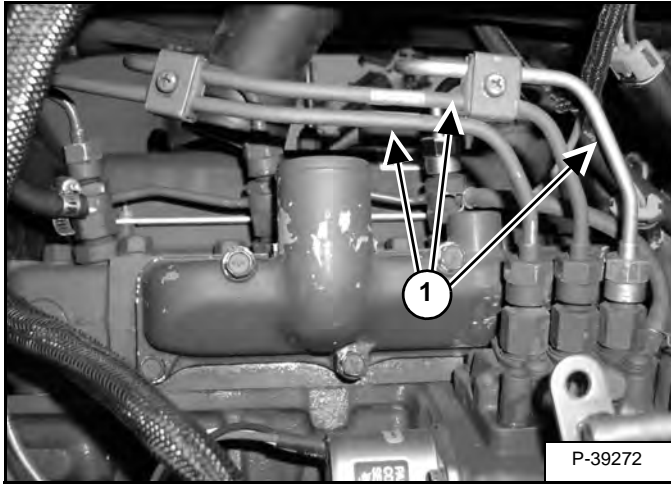

Remove the high pressure fuel lines (Item 1) [Figure 70-70-30] from the injection pump and the injectors.

Installation: Tighten the injection pipe retaining nut to 23 - 26 N•m (17 - 26 ft-lb) torque.

Figure 70-70-31

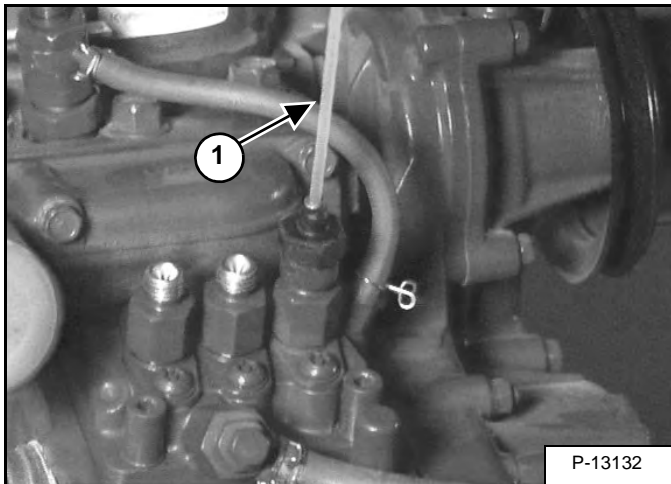

Install a short plastic tube (Item 1) [Figure 70-70-31] in the fitting of the number 1 cylinder port. Point the tube up.

NOTE: The fuel must be in the tube (Item 1) [Figure 70-70-31] before attempting timing.

Figure 70-70-32

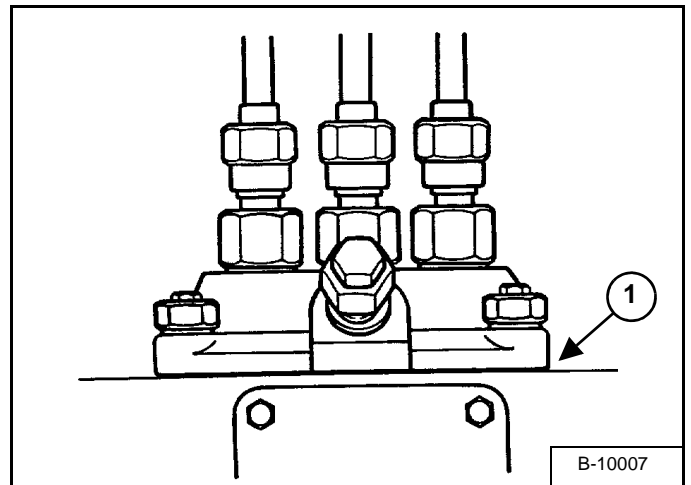

Timing the fuel injection pump is done by changing the number of shims between the injection pump and the injection pump mounting surface (Item 1) [Figure 70-70-32].

Addition or reduction of shim 0,05 mm (0.002 in) will delay or advance the injection timing by approximately 0.5°. The timing of the pump will be later when a shim is added, and earlier when a shim is removed.

Move the fuel lever on the injection pump to full fuel position (or full throttle).

Turn the flywheel clockwise slowly until the fuel starts to rise in the plastic tube (Item 1) [Figure 70-70-31].

Figure 70-70-33

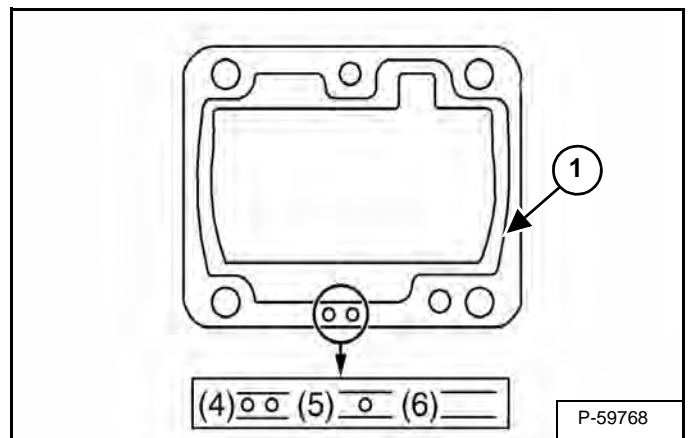

The size of shims (Item 1) [Figure 70-70-3] are identified by a symbol on the shims.

(1) Two holes means 0,20 mm (0.00079 in) shim.

(2) One hole means 0,25 mm (0.0098 in) shim.

(3) Without hole means 0,30 mm (0.00118 in) shim.

FUEL SYSTEM (CONT'D)

Fuel Injection Pump Timing (Cont'd)

Figure 70-70-34

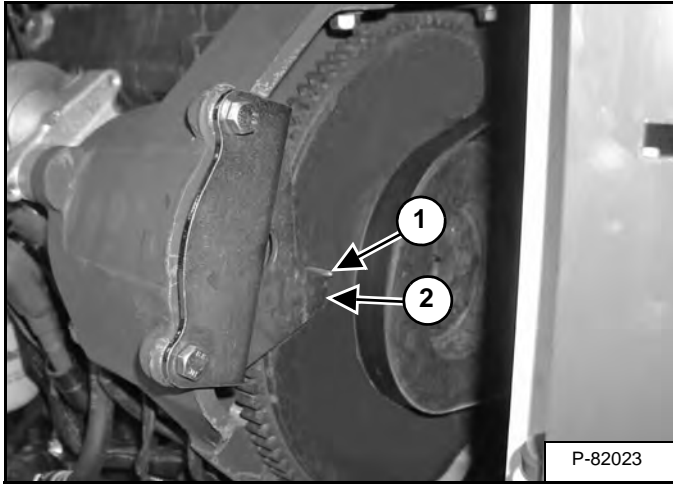

Check the timing mark (Item 1) [Figure 70-70-34] (located on the flywheel) for proper alignment.

When the timing mark is aligned with the marker (Item 2) [Figure 70-70-34], the injection pump timing is correct.

The correct engine timing for all Kubota® D1005-E3B engines is 17-19° B.T.D.C. Add or subtract shims (Item 1) [Figure 70-70-32] to achieve the correct timing.

NOTE: Adding or reducing the shim thickness by 0,05 mm retards or advances the injection timing by approximately 0.5°.

Fuel Injector Nozzles Removal And Installation

WARNING

AVOID INJURY OR DEATH

Diesel fuel or hydraulic fluid under pressure can penetrate skin or eyes, causing serious injury or death. Fluid leaks under pressure may not be visible. Use a piece of cardboard or wood to find leaks. Do not use your bare hand. Wear safety goggles. If fluid enters skin or eyes, get immediate medical attention from a physician familiar with this injury.

W-2072-0807

The tool listed will be needed to do the following procedure:

MEL1485 - Socket

To remove the injector nozzles, use the following procedure:

Figure 70-70-35

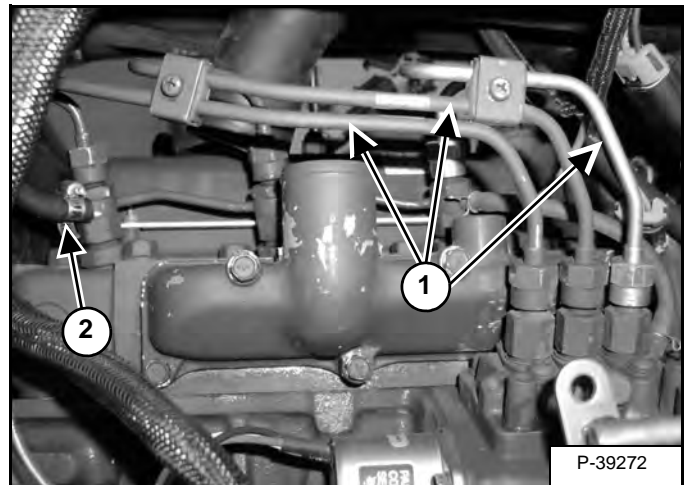

Remove the high pressure fuel lines (Item 1) [Figure 70-70-35] from the injection pump and the injector nozzles.

Installation: Tighten the injection pipe retaining nut to 23 - 36 N•m (17 - 26 ft-lb) torque.

Remove the fuel return hoses (Item 2) [Figure 70-70-35] from the banjo fittings.

Remove the banjo fittings from the fuel injector nozzles.

FUEL SYSTEM (CONT'D)

Fuel Injector Nozzles Removal And Installation (Cont'd)

Figure 70-70-36

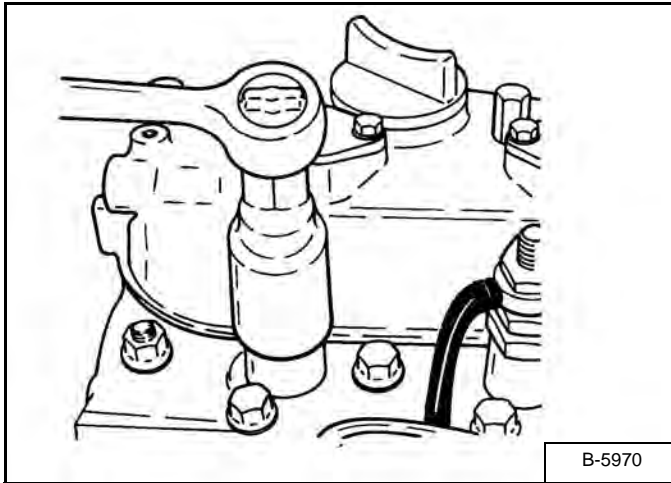

Loosen the fuel injector with a special socket (MEL1485) [Figure 70-70-36].

Installation: Tighten the injectors to 49 - 68,6 N•m (36 - 50 ft-lb) torque.

Figure 70-70-37

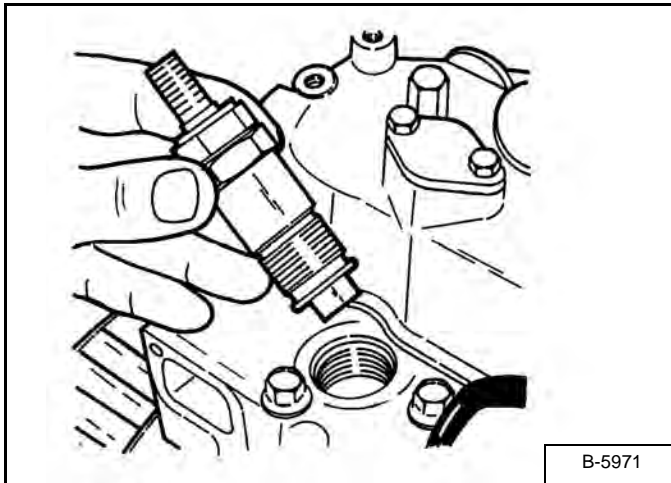

Remove the fuel injector nozzle from the engine [Figure 70-70-37].

IMPORTANT

Do not disassemble or test the fuel injector nozzles unless you have the correct service and testing tools.

I-2027-0284

Fuel Injector Nozzle Pressure - Checking

WARNING

AVOID INJURY OR DEATH

Diesel fuel or hydraulic fluid under pressure can penetrate skin or eyes, causing serious injury or death. Fluid leaks under pressure may not be visible. Use a piece of cardboard or wood to find leaks. Do not use your bare hand. Wear safety goggles. If fluid enters skin or eyes, get immediate medical attention from a physician familiar with this injury.

W-2072-0807

The tools listed will be needed to do the following procedure:

- 4200 - Injector Nozzle Tester
- 4201 - Injector Nozzle Tester Adapter Set

Figure 70-70-38

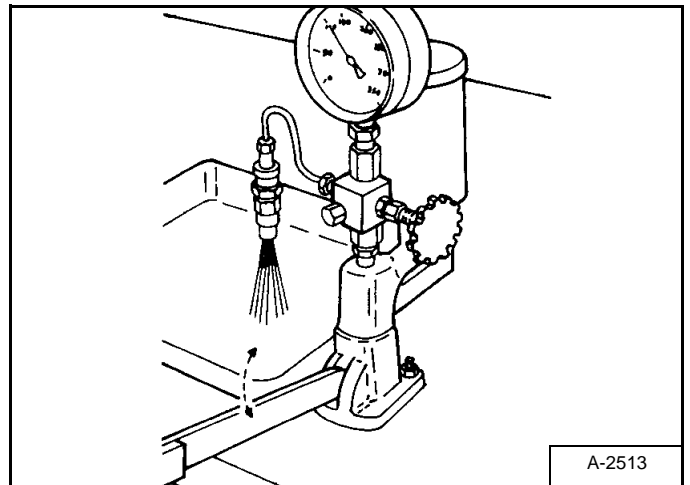

Install the injector nozzle onto the nozzle tester (4200) in the down position [Figure 70-70-38].

Slowly operate the hand lever of the test pump until the injector nozzle valve opens. The pressure must be 13727 - 14707 kPa (137,3 - 147 bar) (1991 - 2133 psi).

FUEL SYSTEM (CONT'D)

Fuel Injector Nozzle Pressure - Checking (Cont'd)

Figure 70-70-39

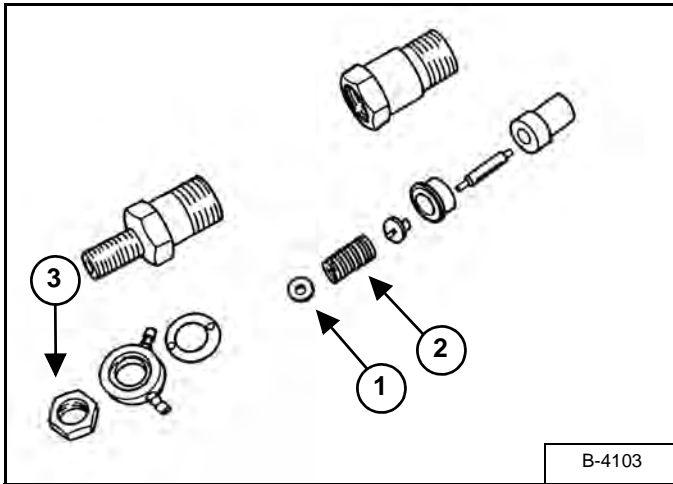

NOTE: You can adjust the release pressure of the injector nozzle by adding or removing spacers (Item 1) from the top of the nozzle spring (Item 2) [Figure 70-70-39]. Each spacer will change the release pressure about 234 kPa (2,3 bar) (34 psi). The release pressure must be 13727 - 14713 kPa (137,3 -147 bar) (1991 - 2134 psi).

If the pressure is not correct, disassemble the injector nozzle and add or remove spacers (Item 1) [Figure 70-70-39].

NOTE: When assembling the injector nozzle, tighten the retainer nut (Item 3) [Figure 70-70-39] to 59 - 79 N•m (43 - 58 ft-lb) torque. Any higher torque will cause slow action of the valve.

Check for inside leakage. Operate the hand lever until the pressure is almost enough to open the injector valve. Make a record of the pressure. Release the hand lever. Check the pressure decrease to 10 seconds. The nozzle has damage if the pressure decrease is more than 5102 kPa (51 bar) (740 psi) in 10 seconds.

Nozzle Spray Condition

Figure 70-70-40

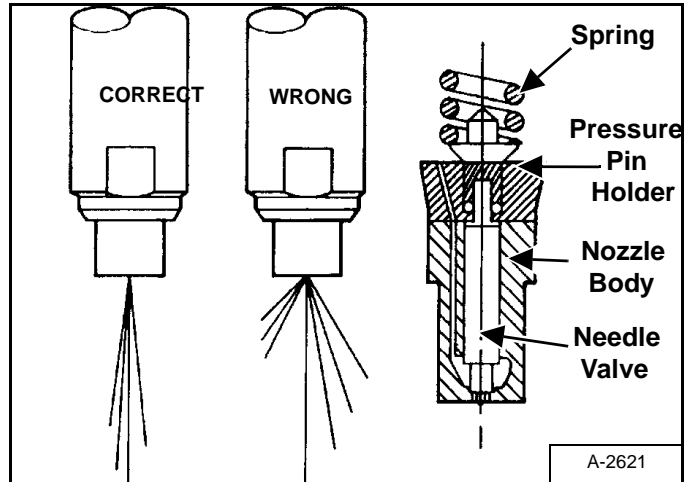

Check that the spray pattern is correct [Figure 70-70-40]:

1. Fuel does not come out of the nozzle.
2. Drops of fuel not present at the nozzle.
3. The injector has an even flow coming from the nozzle.

Any of the above conditions show a defect or a dirty injector nozzle. Clean the nozzle that does not operate correctly and check again.

FUEL SYSTEM (CONT'D)

Valve Seat Tightness

WARNING

AVOID INJURY OR DEATH

Diesel fuel or hydraulic fluid under pressure can penetrate skin or eyes, causing serious injury or death. Fluid leaks under pressure may not be visible. Use a piece of cardboard or wood to find leaks. Do not use your bare hand. Wear safety goggles. If fluid enters skin or eyes, get immediate medical attention from a physician familiar with this injury.

W-2072-0807

Figure 70-70-41

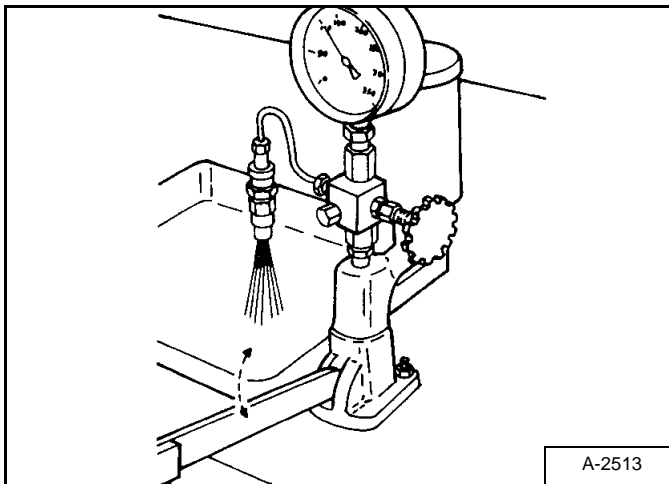

Install the injection nozzle assembly onto the nozzle tester (4200).

Connect the injector nozzle to the tester with the nozzle in the down position **[Figure 70-70-41]**.

Check for inside leakage. Operate the hand lever until the pressure reaches 12748 kPa (127 bar) (1849 psi). Make a record of the pressure. Release the hand lever. Check the pressure decrease in 10 seconds. If any leak is found, replace the nozzle.



Bobcat®

CYLINDER HEAD

Glow Plug - Checking

Figure 70-80-1

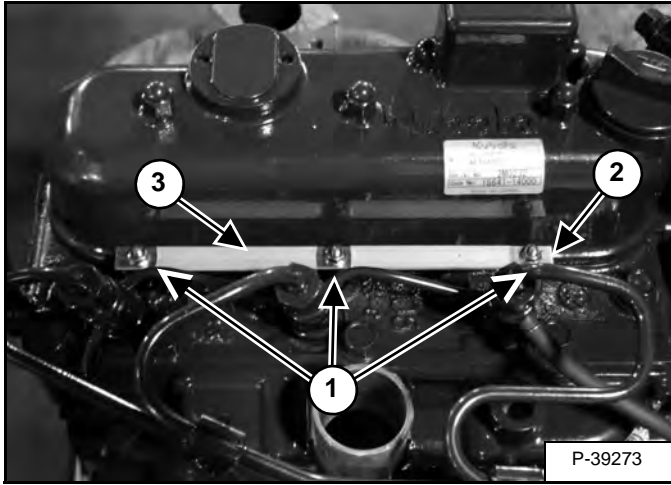

Remove the nuts (Item 1) [Figure 70-80-1] from the glow plug.

Disconnect the engine harness wire (Item 2) [Figure 70-80-1] from the glow plug.

Remove the glow plug connecting strap (Item 3) [Figure 70-80-1].

Figure 70-80-2



Use an ohmmeter to check the glow plugs [Figure 70-80-2].

Touch one probe to the end of the glow plug and the other probe to the body of the glow plug.

The reading should be approximately 0.9 ohm. If the resistance is infinite, the coil of the glow plug is broken. If the resistance is zero the glow plug has a short circuit.

Repeat the procedure for each glow plug.

Glow Plug Removal And Installation

Figure 70-80-3

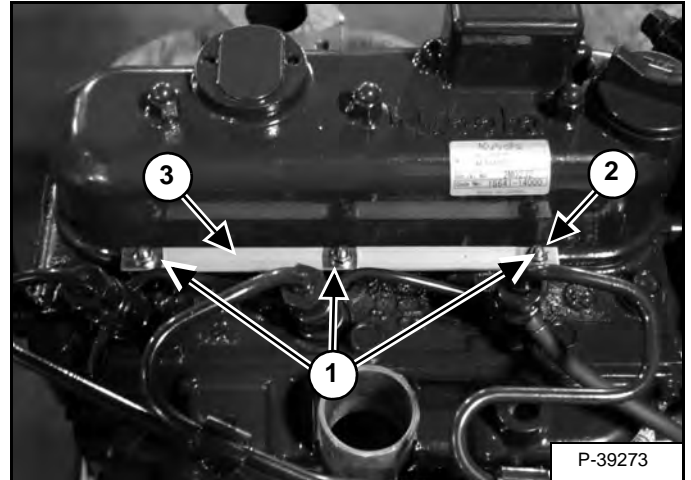

Remove the nuts (Item 1) [Figure 70-80-3] from the glow plug.

Disconnect the engine harness wire (Item 2) [Figure 70-80-3] from the glow plug.

Remove the glow plug connecting strap (Item 3) [Figure 70-80-3].

Figure 70-80-4

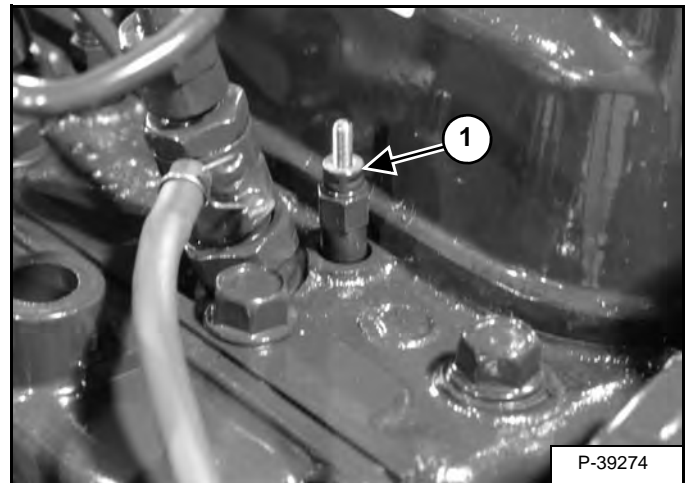

Remove the glow plugs (Item 1) [Figure 70-80-4].

Installation: Tighten the glow plug to 7,8 - 14,7 N•m (5.8 - 10 ft-lb) torque.

CYLINDER HEAD (CONT'D)

Valve Clearance Adjustment

NOTE: The valve clearance must be checked and adjusted when engine is cold.

Remove the glow plugs. (See Glow Plug Removal And Installation on Page 70-80-1.)

Remove the valve cover.

Bring the number 1 piston to "TDC" (Top Dead Center).

Figure 70-80-5

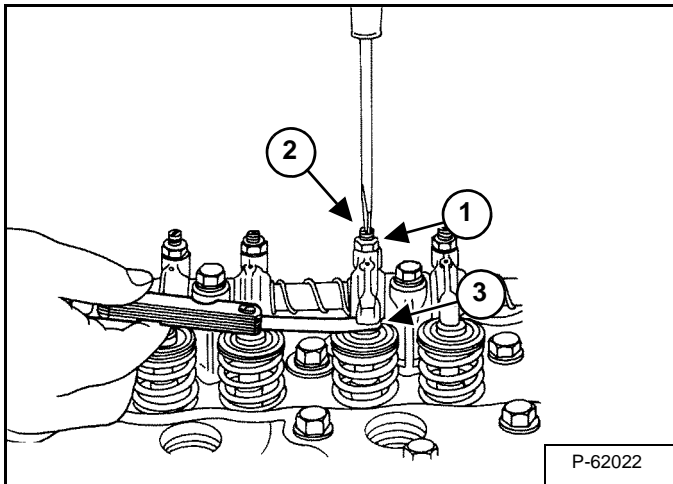

Adjust the valve clearance as follows:

Loosen the locknut (Item 1) [Figure 70-80-5].

Turn the adjustment screw (Item 2) [Figure 70-80-5] until the correct clearance is obtained.

NOTE: The clearance is measured between the rocker arm and valve stem tip (Item 3) [Figure 70-80-5].

If adjustments are necessary, tighten locknut before moving on to the next rocker arm.

Figure 70-80-6

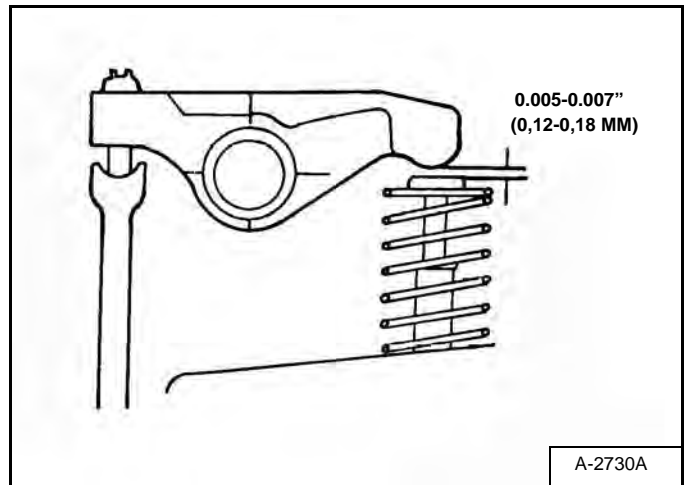

Make sure the piston is at TDC when adjusting the clearance at the valves. The correct clearance is 0,12 - 0,18 mm (0.005 - 0.007 in) cold clearance [Figure 70-80-6].

Figure 70-80-7

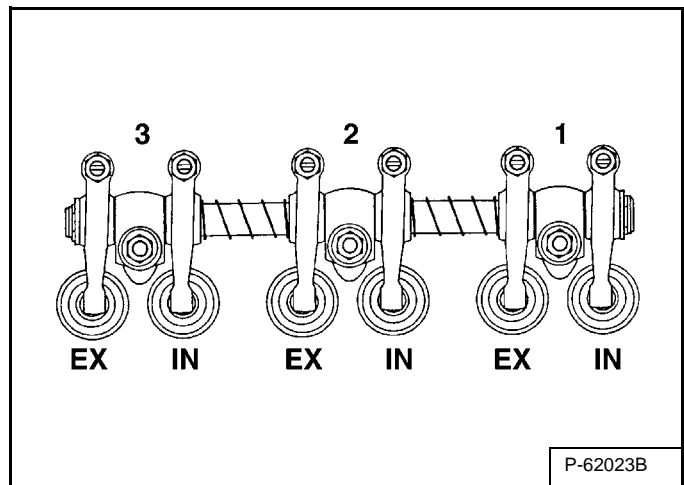

With No. 1 piston at TDC (compression) both the intake and exhaust valves are up. Set both No.1 valves, No. 2 Exhaust valve and No. 3 intake valve [Figure 70-80-7].

Rotate the flywheel 360°, No. 1 piston (overlap position). Set No. 2 intake valve and No. 3 exhaust valve [Figure 70-80-7].

CYLINDER HEAD (CONT'D)

Valve Timing Checking

Remove the engine. (See Engine Removal And Installation on Page 70-10-9.)

Remove the timing gearcase cover. (See Timing Gearcase Cover Removal And Installation on Page 70-100-1.)

Figure 70-80-8

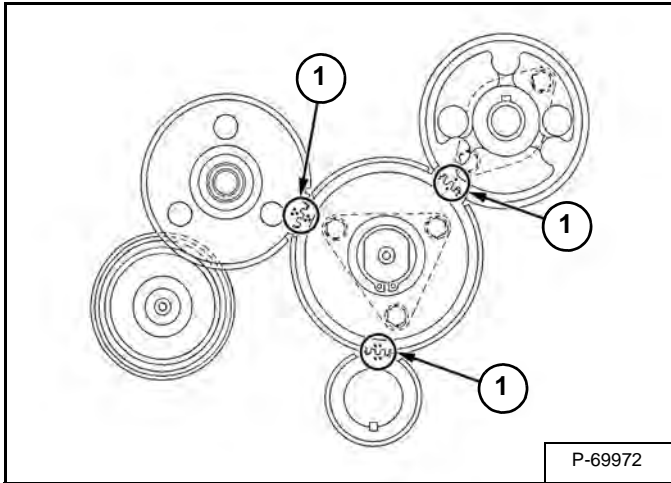

Make sure the timing marks (Item 1) [Figure 70-80-8] are in correct alignment.

Cylinder Head Removal And Installation

Remove the engine. (See Engine Removal And Installation on Page 70-10-9.)

Remove the glow plugs. (See Glow Plug Removal And Installation on Page 70-80-1.)

Remove the fuel injector nozzles. (See Fuel Injector Nozzles Removal And Installation on Page 70-70-12.)

Figure 70-80-9

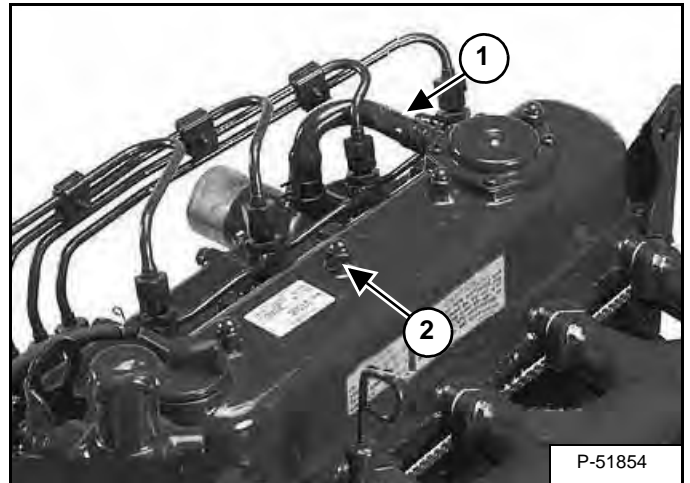

Remove the breather hose (Item 1) [Figure 70-80-9].

Remove the valve cover nuts (Item 2) [Figure 70-80-9] from the valve cover.

Installation: Tighten valve cover nuts to 7 - 8 N•m (5 - 6 ft-lb) torque.

Remove the valve cover and replace the gasket if needed.

CYLINDER HEAD (CONT'D)

Cylinder Head Removal And Installation (Cont'd)

Figure 70-80-10

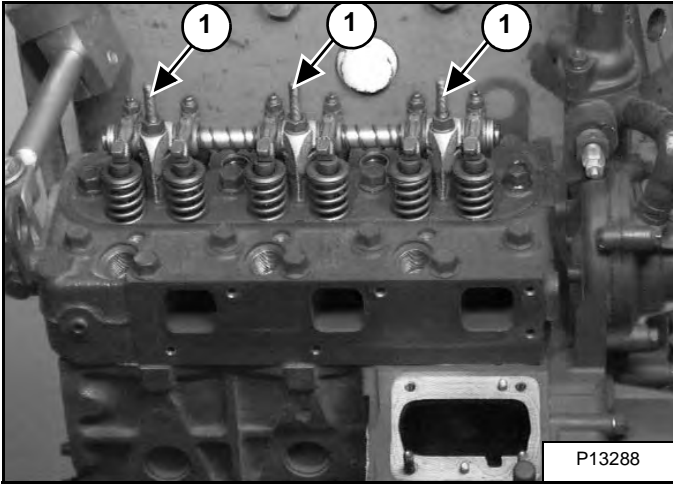

Remove the three mounting nuts from the rocker arms bracket (Item 1) [Figure 70-80-10], and remove the rocker arms from the head.

Installation: Tighten the mounting nuts to 22 - 26 N•m (16 - 19 ft-lb) torque.

Figure 70-80-11

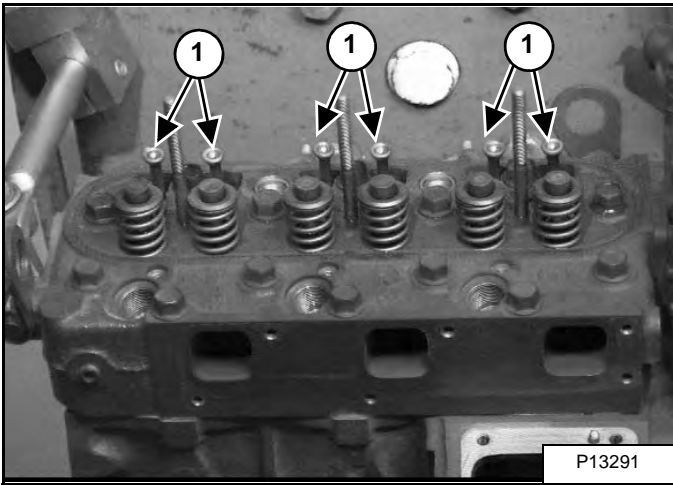

NOTE: Mark the push rods to prevent interchanging when installing.

Remove the six push rods (Item 1) [Figure 70-80-11].

Figure 70-80-12

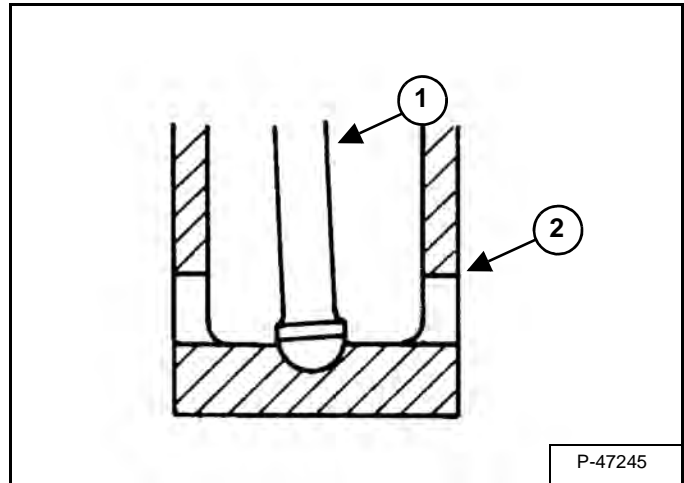

Installation: The push rod (Item 1) must be seated in the tappet (Item 2) [Figure 70-80-12] correctly or the push rods will be damaged.

After installing the rocker arm assembly and push rods, the valve lash must be adjusted.

Figure 70-80-13

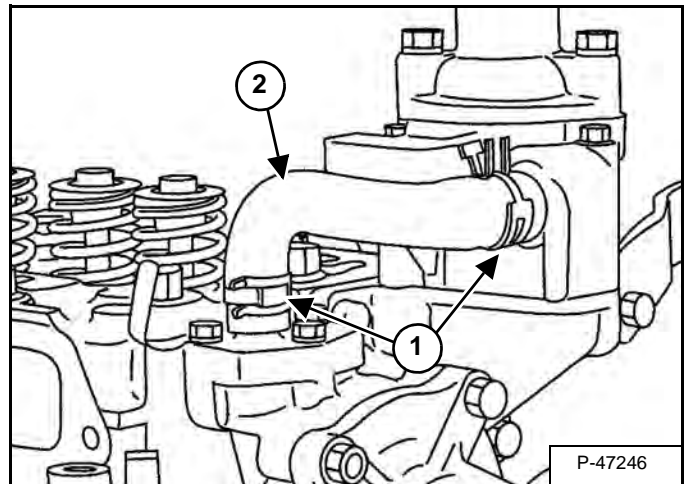

Remove the clamps (Item 1) and remove the hose (Item 2) [Figure 70-80-13] from the thermostat housing.

Remove the intake and exhaust manifolds.

CYLINDER HEAD (CONT'D)

Cylinder Head Removal And Installation (Cont'd)

Figure 70-80-14

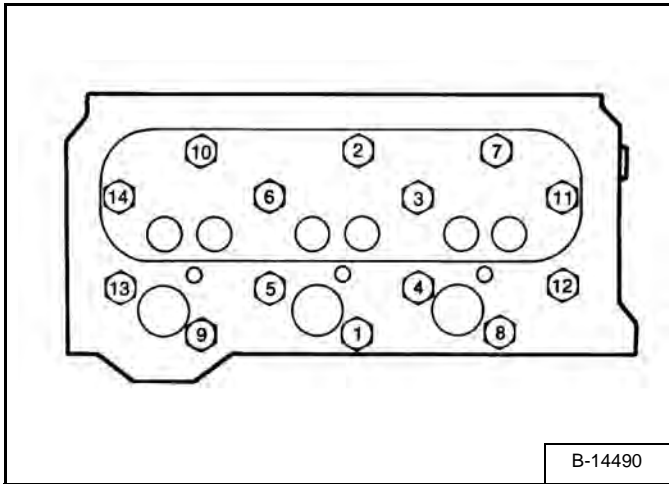

Remove the cylinder head bolts in order of #14 to #1 [Figure 70-80-14].

Installation: Put oil on the bolt threads. Tighten the bolts in the sequence of #1 to #14 to 64 - 69 N•m (47 - 51 ft-lb) torque.

NOTE: Re-tighten the cylinder head bolts in the correct sequence after the engine has been run for about 30 minutes.

Figure 70-80-15

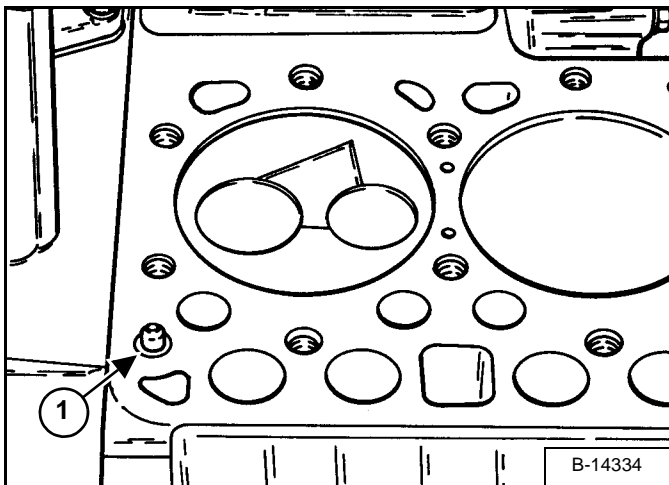

Remove the cylinder head from the engine block.

Installation: Always use a new head gasket and new O-ring. Make sure the O-ring (Item 1) [Figure 70-80-15] is seated over the dowel.

Figure 70-80-16

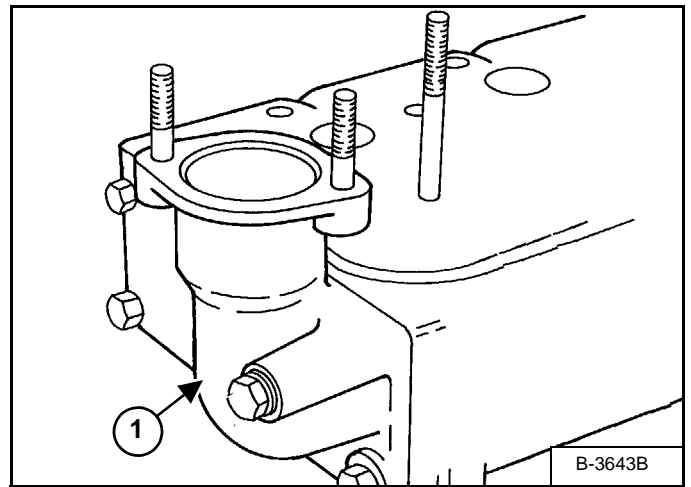

Remove the four mounting bolts at the coolant housing (Item 1) [Figure 70-80-16].

Remove the coolant housing from the head.

Figure 70-80-17

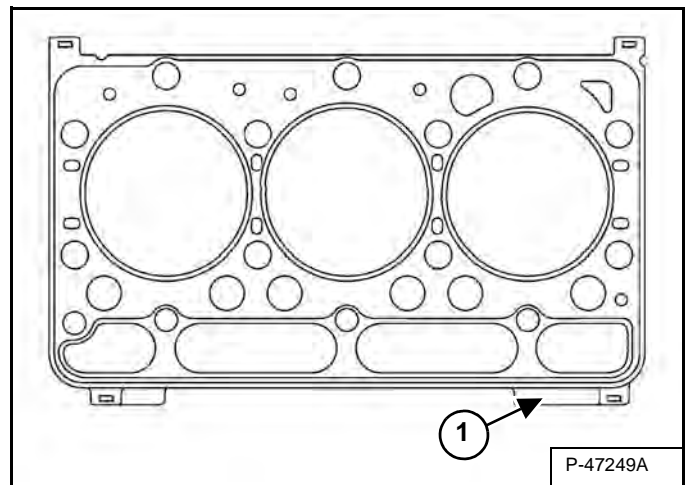

When replacing just the gasket, use a new gasket that has the same mark (Item 1) [Figure 70-80-17] as the original gasket.

When replacing the gasket after an engine rebuild, the piston protrusion must be measured. (See Cylinder Head Top Clearance on Page 70-80-7.)

After the gasket and cylinder head have been installed, turn the crankshaft by hand to be sure there is no interference between the piston, cylinder and valves.

CYLINDER HEAD (CONT'D)

Cylinder Head Disassembly And Assembly

Figure 70-80-18

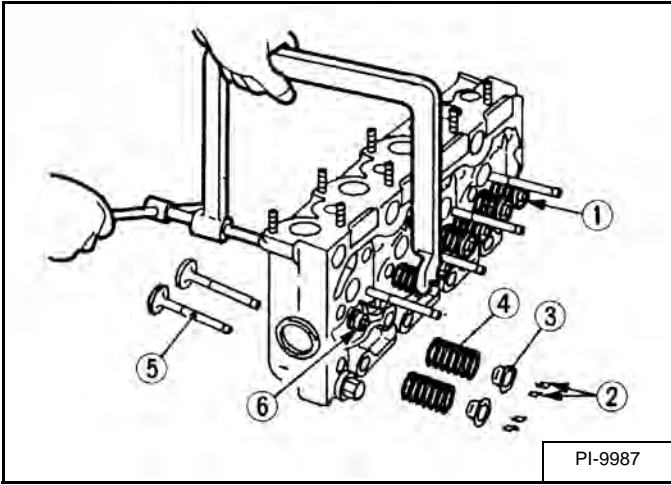

Use a valve spring compressor to compress the valve spring [Figure 70-80-18].

Figure 70-80-19

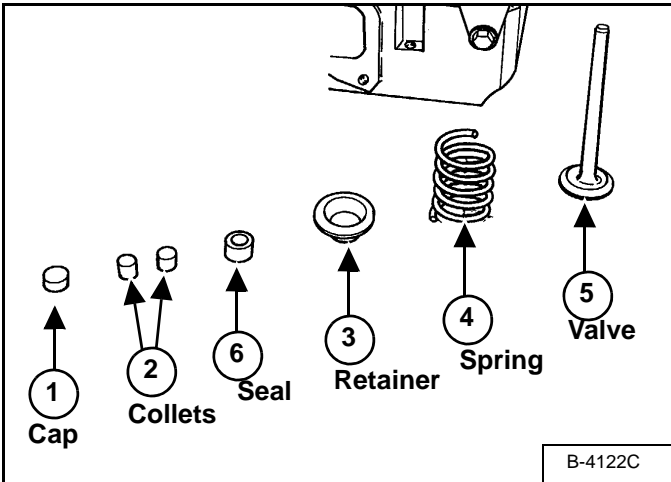

Remove the valve cap (Item 1) and valve spring collet (Item 2) [Figure 70-80-18] and [Figure 70-80-19].

Remove the valve spring retainer (Item 3) and the spring (Item 4) [Figure 70-80-18] and [Figure 70-80-19].

Remove the seal (Item 6) and the valve (Item 5) [Figure 70-80-18] and [Figure 70-80-19].

Cylinder Head - Servicing

Clean the surface of the cylinder head.

Figure 70-80-20

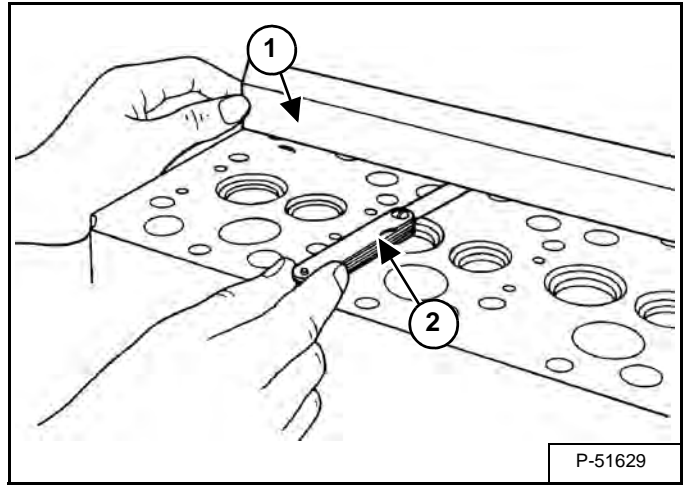

Put a straight edge (Item 1) [Figure 70-80-20] on the cylinder head.

NOTE: Do not put the straight edge across combustion chambers.

Put a feeler gauge (Item 2) [Figure 70-80-20] between the straight edge and the surface of the cylinder head.

Figure 70-80-21

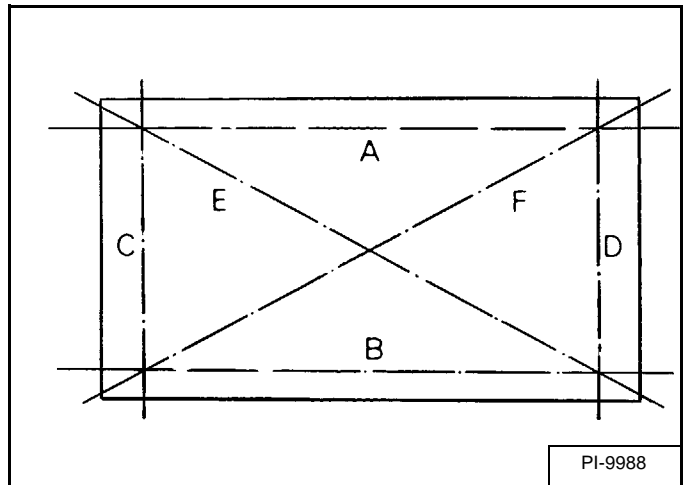

Put the straight edge on the cylinder head's four sides and two diagonal as shown in figure [Figure 70-80-21].

The maximum distortion of the head surface is $\pm 0,05$ mm (0.002 in). If the measurement exceeds the specification, replace the cylinder head.

CYLINDER HEAD (CONT'D)

Cylinder Head Top Clearance

Figure 70-80-22

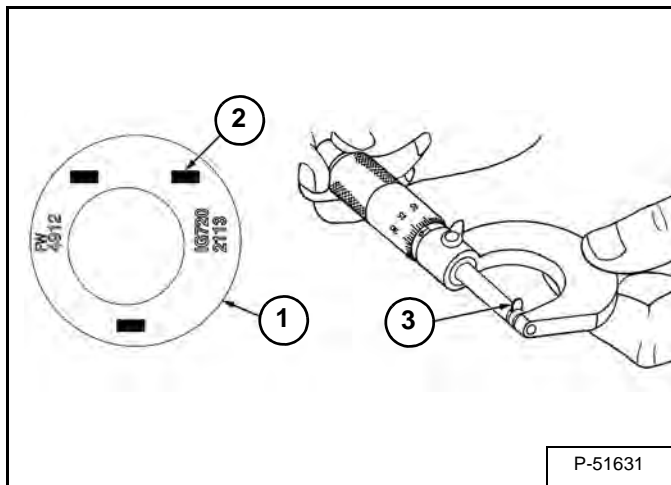

Install the cylinder head gasket. Put the piston (Item 1) [Figure 70-80-22] being checked at T.D.C.

Put 3 pieces of 1,5 mm (0.06 in) diameter solder (Item 2) [Figure 70-80-22] on the top of the piston. Use grease to hold them in position.

NOTE: Put the solder in position so they do not touch the valves.

Turn the piston to bottom dead center.

Install the cylinder head and tighten to the correct torque in the correct sequence. (See Cylinder Head Removal And Installation on Page 70-80-3.)

Turn the crankshaft until the piston exceeds T.D.C. Remove the cylinder head.

Remove the solder wire (Item 3) [Figure 70-80-22] and measure it.

If the measurement exceeds the specifications, check the oil clearance of the crank pin journal or the piston pin.

Top Clearance 0,55 - 0,70 mm (0.022 - 0.027 in)

Valve Guide - Checking

Remove the valve and spring from the cylinder head. (See Cylinder Head Disassembly And Assembly on Page 70-80-6.)

Clean the valve seat and combustion chamber.

Figure 70-80-23

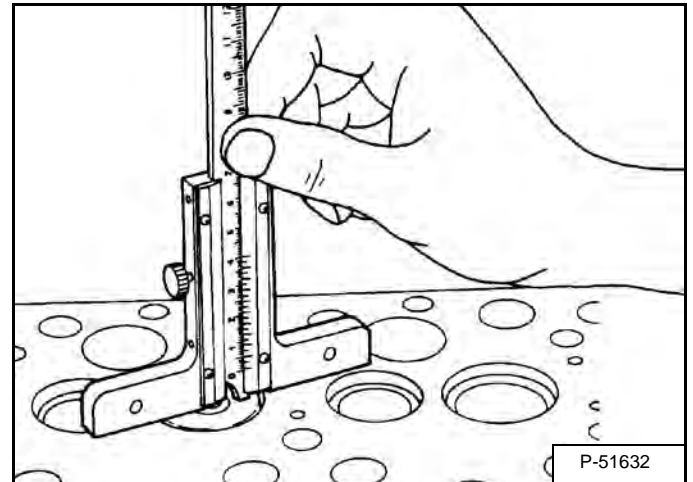

Install the valve into the guide. Measure the valve recessing or protrusion with a depth gauge [Figure 70-80-23].

Figure 70-80-24

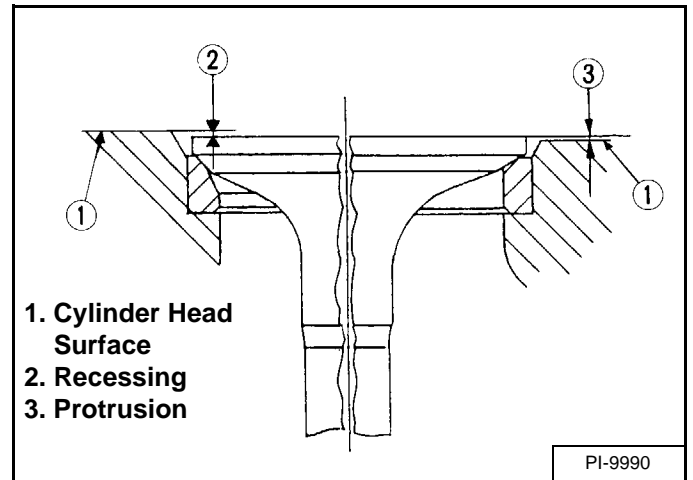

If the measurement exceeds the allowable limit, replace the valve or cylinder head [Figure 70-80-24].

Protrusion	0,5 mm (0.002 in)
Recessing	0,15 mm (0.0098 in)
Allowable Limit (Recessing)	0,4 mm (0.016 in)

Remove the carbon from the valve guide.

CYLINDER HEAD (CONT'D)

Valve Guide - Checking (Cont'd)

Figure 70-80-25

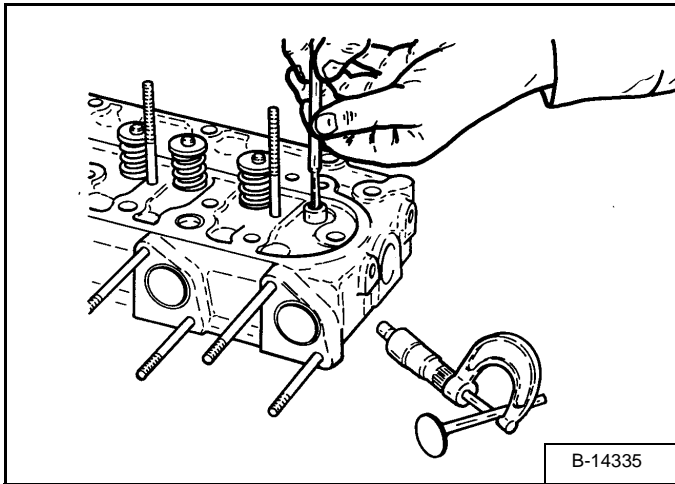

Measure the valve stem O.D. [Figure 70-80-25].

Measure the valve guide I.D. [Figure 70-80-25].

Calculate the clearance. If the clearance exceeds the allowable limit, replace the valve and / or valve guide.

Valve Guide I.D.	7,01 - 7,025 mm (0.2760 - 0.2765 in)
Valve Stem O.D.	6,96 - 6,98 mm (0.2741 - 0.2746 in)
Clearance Between Valve Stem and Guide	0,04 - 0,07 mm (0.0014 - 0.0025 in)
Allowable Limit	0,1 mm (0.0039 in)

Figure 70-80-26

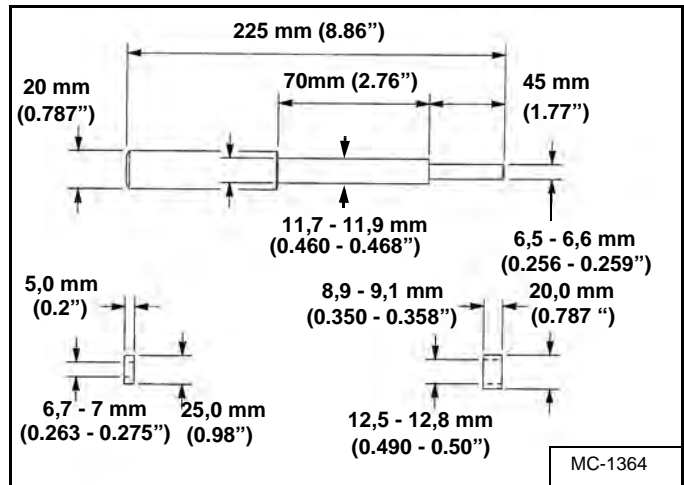

To remove and replace the valve guide, make the driver tool as shown in figure [Figure 70-80-26].

Figure 70-80-27

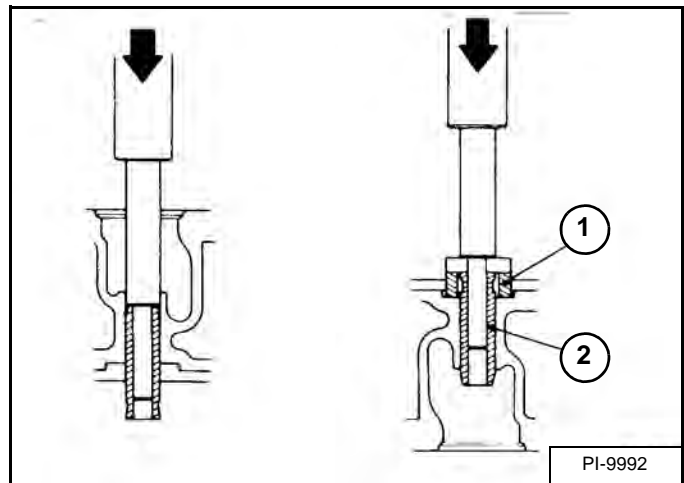

Press the used valve guide out of the cylinder head using the special driver tool [Figure 70-80-27].

Put oil on the outside diameter of the new valve guide. Press the new valve guide into the cylinder head from the top side. Use the special driver tools (Items 1 and 2) [Figure 70-80-27], press the new guide until the tool contacts the cylinder head.

Ream the valve guide to the correct specifications.

CYLINDER HEAD (CONT'D)

Reconditioning The Valve And Valve Seat

Figure 70-80-28

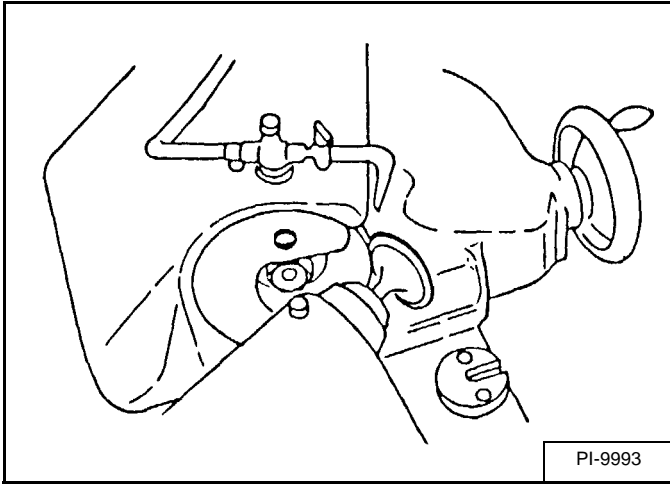

Grind the valve face to the correct angle using a valve refacer [Figure 70-80-28].

Figure 70-80-29

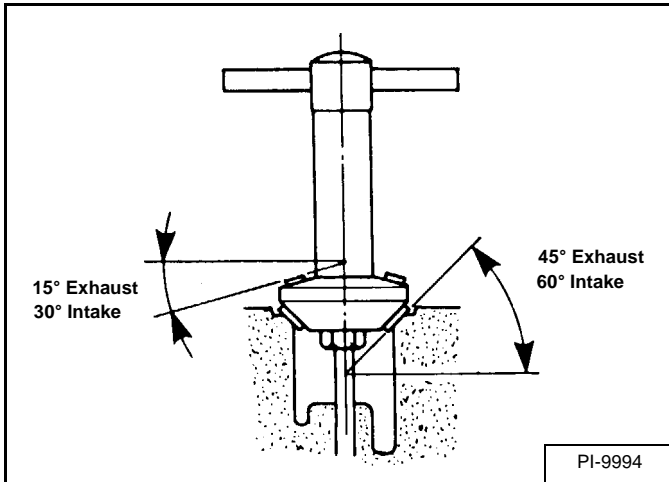

Grind the valve seat surface in the cylinder head to the correct angle [Figure 70-80-29].

Figure 70-80-30

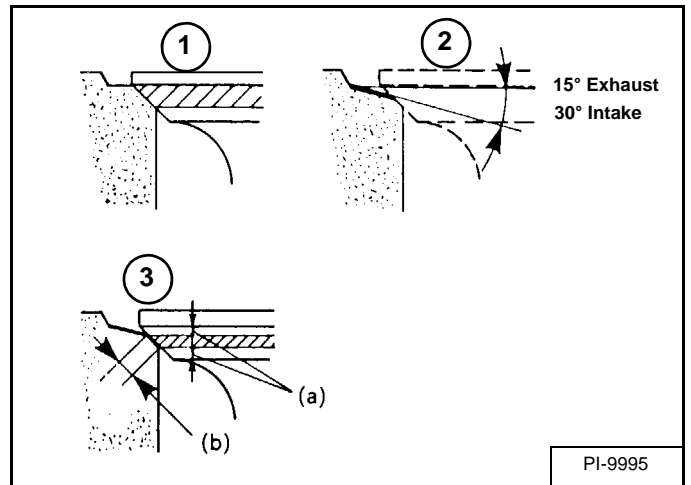

Check the seat surface and valve face (Item 1) [Figure 70-80-30].

(a) identical dimensions above and below the valve seat

If the seat surface (b) is too wide, use a 30 degree cutter (Item 2) on the intake, and a 15 degree cutter on the exhaust to get the correct width (Item 3) [Figure 70-80-30].

Valve Seat Width

Intake	2,12 mm (0.0835 in)
Exhaust	2,12 mm (0.0835 in)

Valve Seat And Face Angle

Intake	60°
Exhaust	45°

CYLINDER HEAD (CONT'D)

Valve Spring

Figure 70-80-31

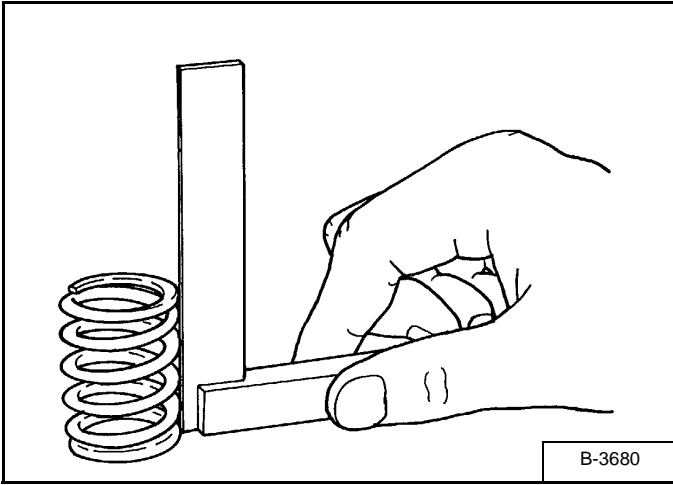

Measure the length of the valve spring. If the measurement is less than the allowable limit, replace the spring **[Figure 70-80-31]**.

Free Length	37 - 37,5 mm (1.46 - 1.47 in)
Allowable Limit	36,5 mm (1.44 in)

Put the spring on a flat surface, place a square on the side of the spring **[Figure 70-80-31]**.

Rotate the spring and measure the maximum tilt. If the measurement excess the allowable limit, replace the spring.

Tilt Allowable Limit	1,0 mm (0.039 in)
----------------------	-------------------

Figure 70-80-32

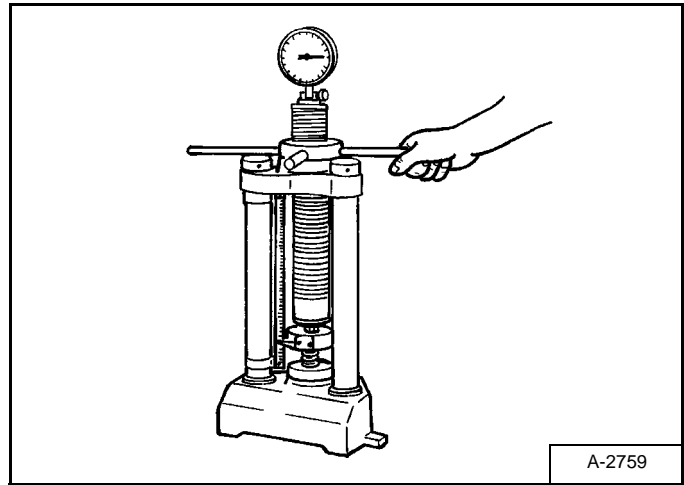

Put the spring on a tester and compress to specified length **[Figure 70-80-32]**.

Read the compressed load on the gauge. If the measurement exceeds allowable limit, replace the spring.

Setting Length	31,0 mm (1.22 in)
Setting Load	117,4 N (26.4 lb)
Allowable Limit	100,0 N (22.5 lb)

CYLINDER HEAD (CONT'D)

Valve Tappets

Figure 70-80-33

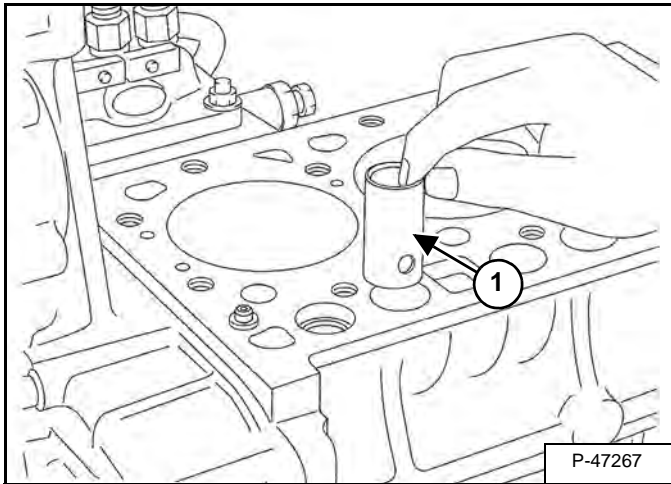

Remove the valve tappets (Item 1) [Figure 70-80-33].

Figure 70-80-34

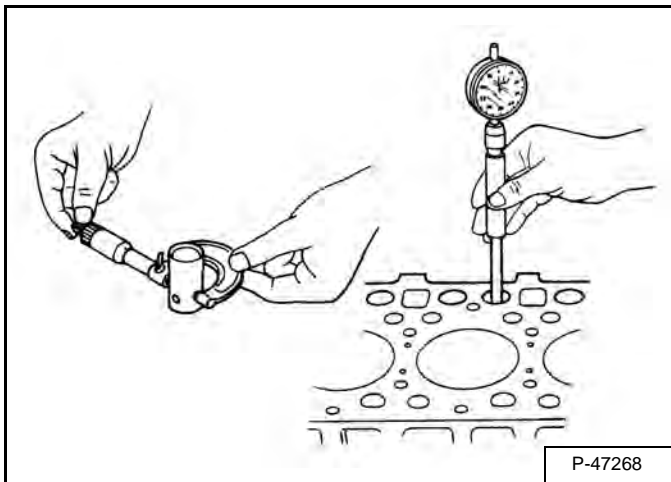

Measure the O.D. of the tappet [Figure 70-80-34].

Measure the ID of the tappet bore [Figure 70-80-34].

If the clearance exceeds the allowable limit, replace the tappets.

Tappet OD	19,959 - 19,980 mm (0.7858 - 0.7866 in)
Tappet Bore ID	20 - 20,02 mm (0.7874 - 0.7882 in)
Clearance Between Tappet and Tappet Bore	0,02 - 0,06 mm (0.0008 - 0.0024 in)
Allowable limit	0,07 mm (0.003 in)

Rocker Arm And Shaft - Checking

Figure 70-80-35

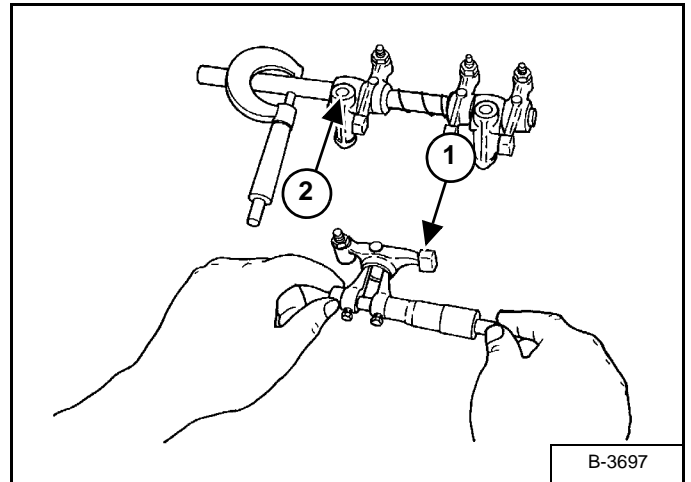

Measure the rocker arm I.D. (Item 1) [Figure 70-80-35] with an inside micrometer.

Measure the rocker arm shaft O.D. (Item 2) [Figure 70-80-35] with an outside micrometer.

If the clearance exceeds the allowable limit, replace the bushing.

If the clearance still exceeds the allowable limit after the bushing is replaced, replace the rocker arm shaft.

Oil Clearance Between Rocker Arm & Shaft

	0,016 - 0,045 mm (0.0006 - 0.0018 in)
Allowable Limit	0,10 mm (0.004 in)
Rocker Arm Shaft O.D.	11,973 - 11,984 mm (0.4714 - 0.4718 in)
Rocker Arm I.D.	12,0 - 12,018 mm (0.4724 - 0.4731 in)



Bobcat®

CRANKSHAFT AND PISTONS

Piston And Connecting Rod Removal And Installation

Remove the cylinder head. (See Cylinder Head Removal And Installation on Page 70-80-3.)

Remove the top edge from the cylinder bore with a ridge reamer.

Remove the oil pan. (See Oil Pan Removal And Installation on Page 70-60-1.)

Figure 70-90-1

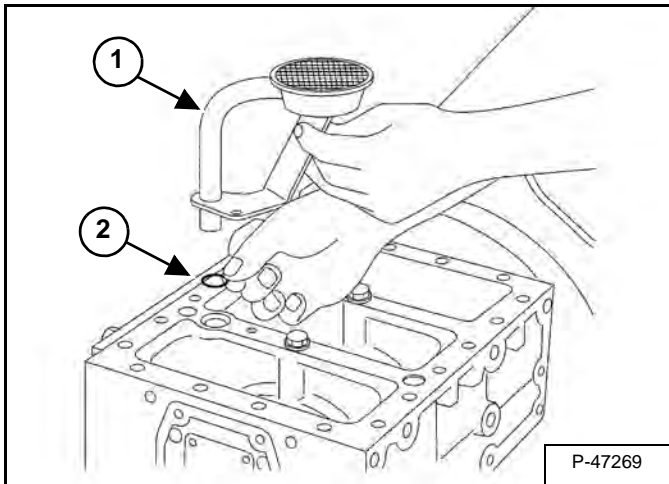

Remove the oil pump strainer (Item 1) and O-ring (Item 2) [Figure 70-90-1] by tapping the edge of the strainer with a soft faced hammer.

Turn the flywheel and put a pair of connecting rods at bottom dead center.

Remove the connecting rod bolts.

Installation: Tighten the connecting rod bolts to 44 - 49 N•m (33 - 36 ft-lb) torque.

Figure 70-90-2

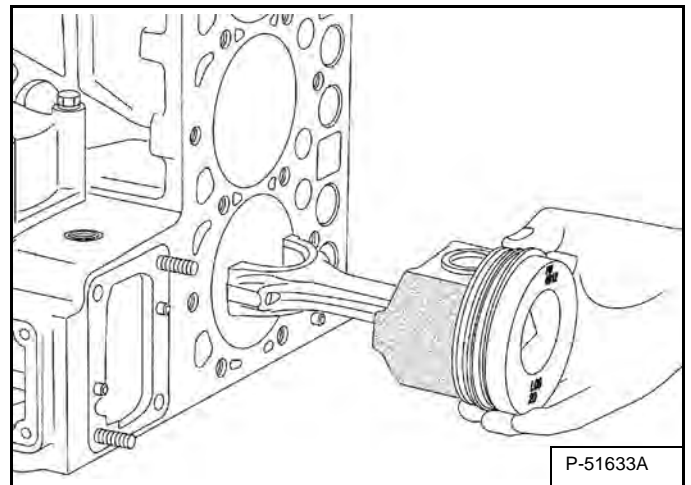

Remove the rod cap and bearing [Figure 70-90-2].

Use a hammer handle and push the piston / connecting rod assembly out of the cylinder bore [Figure 70-90-2].

NOTE: Make sure the pistons are marked so they will be returned to the same cylinder bore.

Figure 70-90-3

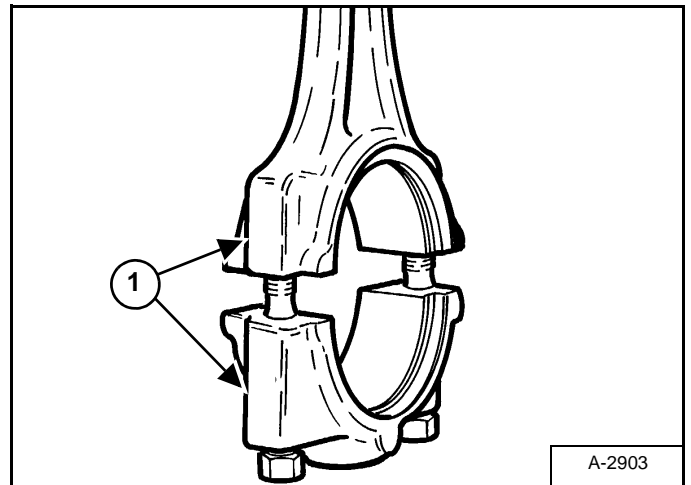

Installation: Make sure the marks (Item 1) on the connecting rod and bearing are aligned when installing the bearing cap [Figure 70-90-3].

Installation: Face the marks toward the injection pump when installing the pistons.

Repeat the procedure to remove the other piston / connecting rod assemblies from the engine block.

CRANKSHAFT AND PISTONS (CONT'D)

Piston And Connecting Rod Removal And Installation (Cont'd)

Figure 70-90-4

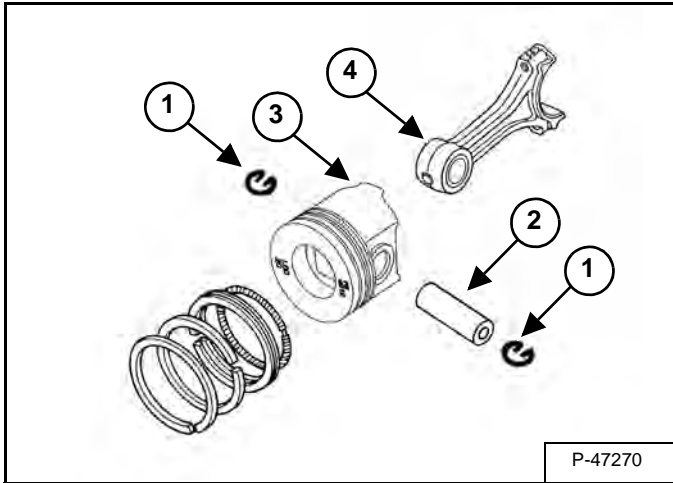

Remove the piston rings [Figure 70-90-4].

Remove the snap ring (Item 1) and piston pin (Item 2) [Figure 70-90-4].

Separate the piston (Item 3) from the connecting rod (Item 4) [Figure 70-90-4].

Figure 70-90-5

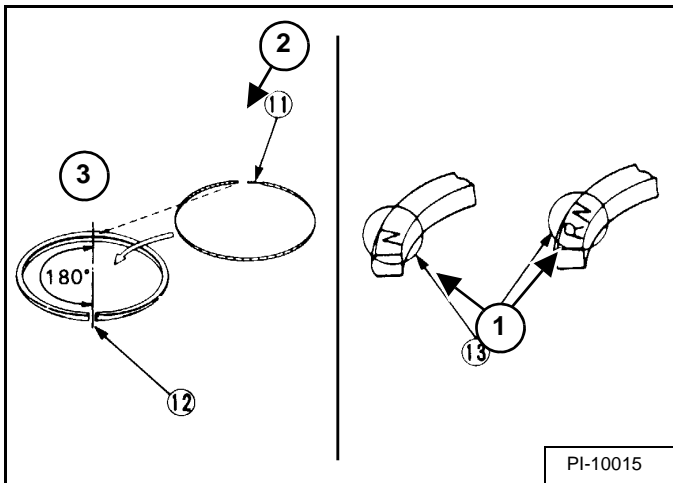

Installation: When installing new rings, assemble the ring so the mark (Item 1) near the gap faces the top of the piston. When installing the oil ring, place the expander joint (Item 2) on the opposite side of the oil ring gap (Item 3) [Figure 70-90-5].

Figure 70-90-6

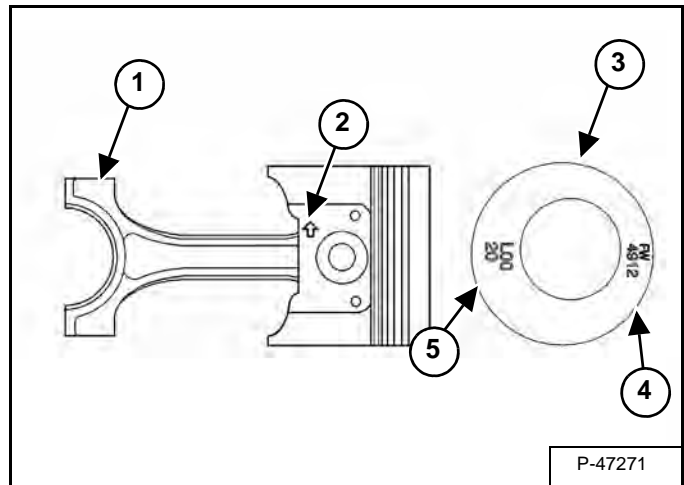

Installation: When reassembling, align the marks (Item 1) on the connecting rod and piston (Item 2). Heat the piston in clean engine oil to 80°C (176°F) and tap the piston pin into position. Place the piston rings so that there are gaps every 120° (Items 3, 4 and 5) [Figure 70-90-6] with no gap facing the piston pin in the cylinder.

Piston And Connecting Rod - Servicing

Figure 70-90-7

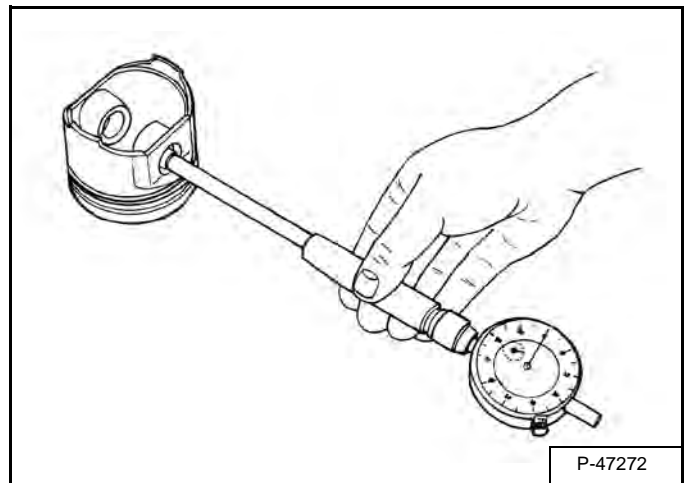

Measure the I.D. of the piston pin bore in both horizontal and vertical directions [Figure 70-90-7].

If the measurement exceeds the allowable limit, replace the piston.

Piston Bore I.D.	22,0 - 22,013 mm (0.8661 - 0.8667 in)
Allowable Limit	22,02 mm (0.8673 in)

CRANKSHAFT AND PISTONS (CONT'D)

Piston And Connecting Rod - Servicing (Cont'd)

Figure 70-90-8

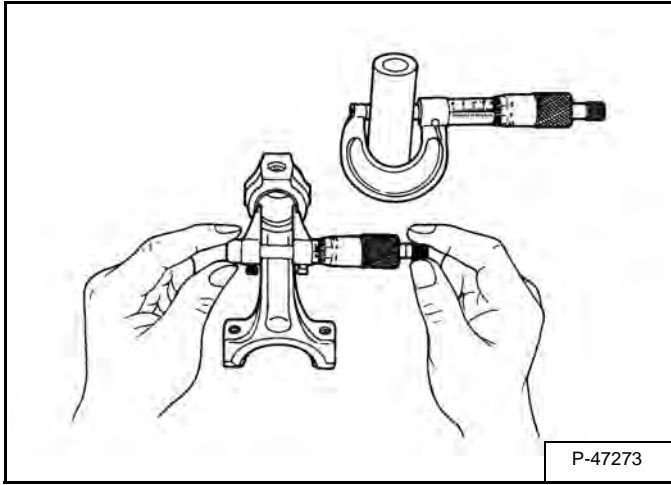

Measure the O.D. of the piston pin [Figure 70-90-8].

Measure the I.D. of the connecting rod small end [Figure 70-90-8].

Calculate the oil clearance. If the clearance exceeds the allowable limit, replace the bushing. If it still exceeds the specifications, replace the piston pin.

Piston Pin O.D.	22,002 - 22,011 mm (0.8662 - 0.8666 in)
Bushing I.D.	22,025 - 22,04 mm (0.8671 - 0.8677 in)
Oil Clearance Between Piston Pin & Bushing	0,014 - 0,038 mm (0.00055 - 0.0014 in)
Allowable Limit	0,15 mm (0.0059 in)

Figure 70-90-9

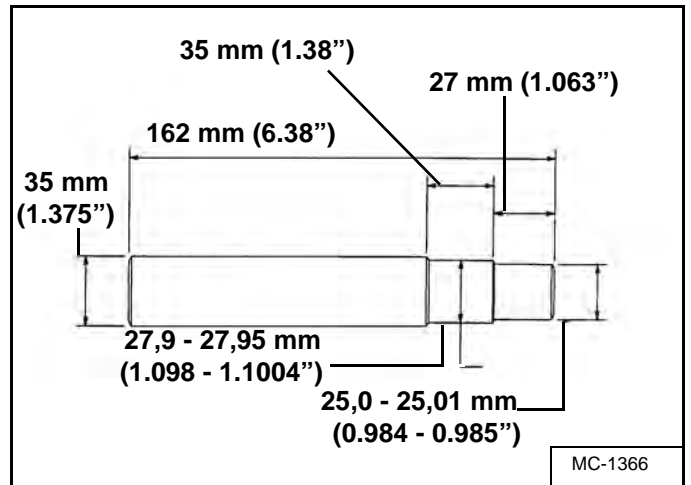

To replace the connecting rod small end bushing, make a driver tool as shown in figure [Figure 70-90-9].

Figure 70-90-10

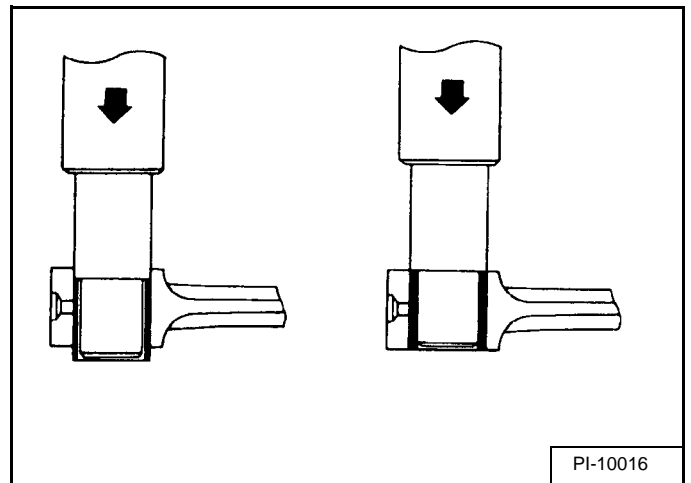

Use a press and special driver tool to remove the small end bushing [Figure 70-90-10].

Installation: Clean the small end bushing and bore. Put oil on the bushing and press into the connecting rod until it is flush [Figure 70-90-10].

CRANKSHAFT AND PISTONS (CONT'D)

Piston And Connecting Rod - Servicing (Cont'd)

Figure 70-90-11

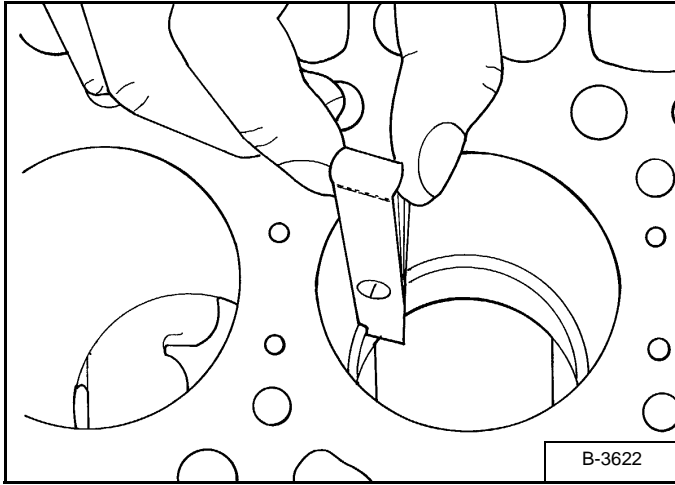

Install a piston ring into the lower part of the cylinder bore. Measure the ring gap with a feeler gauge **[Figure 70-90-11]**.

If the gap exceeds the allowable limit, replace the ring.

Top Ring Gap	0,3 - 0,45 mm (0.012 - 0.017 in)
Oil Ring Gap	0,25 - 0,40 mm (0.0099 - 0.0157 in)
Allowable Limit	1,25 mm (0.0492 in)
Second Ring Gap	0,30 - 0,45 mm (0.012 - 0.0177 in)

Figure 70-90-12

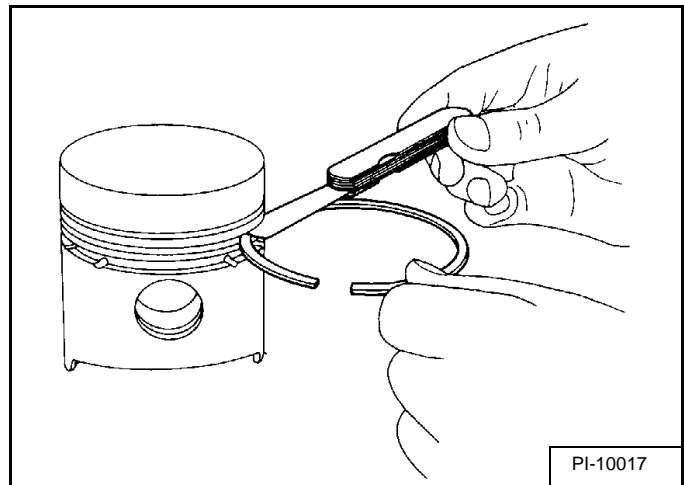

Remove the carbon from the ring grooves. Measure the clearance between the ring and groove with a feeler gauge **[Figure 70-90-12]**.

If the clearance exceeds the allowable limit, replace the ring. If the clearance still exceeds the allowable limit, replace the piston.

Compression Rings	0,085 - 0,112 mm (0.0033 - 0.0044 in)
Allowable Limit	0,2 mm (0.0079 in)
Oil Ring	0,02 - 0,06 mm (0.0008 - 0.0021 in)
Allowable Limit	0,15 mm (0.0059 in)

CRANKSHAFT AND PISTONS (CONT'D)

Cylinder Bore - Checking

Figure 70-90-13

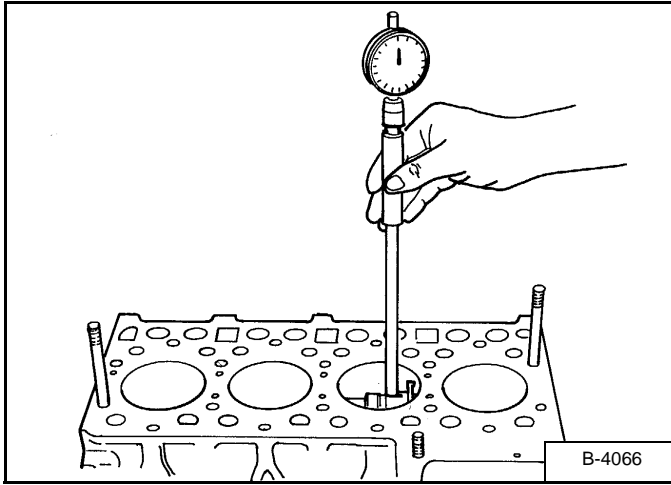

Use a gauge to check the inside measurement of the cylinder bore [Figure 70-90-13].

Figure 70-90-14

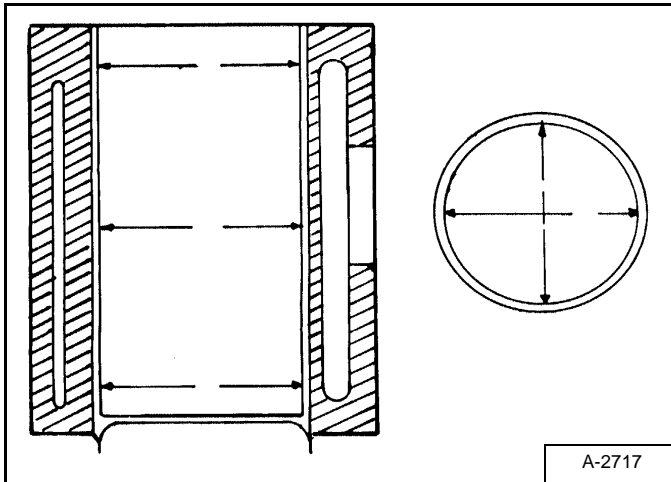

Measure the six points as shown in figure [Figure 70-90-14] to find the maximum wear.

The factory specifications are:

76,0 - 76,019 mm (2.9922 - 2.9929 in).

The wear limit is 76,15 mm (2.998 in).

If the cylinder bore is not within specifications, re-bore the cylinder for oversize piston.

Connecting Rod Alignment

NOTE: The small end bushing is the basis of this check, check the bushing for wear before doing this check.

Install the piston pin into the connecting rod.

Install the connecting rod on an alignment tool.

Put the gauge over the piston pin and move it against the face plate.

Figure 70-90-15

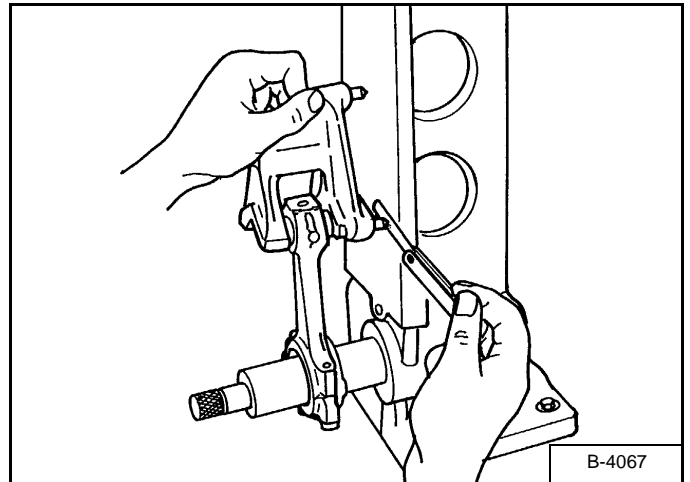

If the gauge does not fit squarely against the face plate, measure the space between the gauge and face plate [Figure 70-90-15].

If the measurement exceeds the allowable limit, replace the connecting rod.

Rod Alignment 0,05 mm (0.002 in)

CRANKSHAFT AND PISTONS (CONT'D)

Crankshaft And Bearings Removal And Installation

Remove the piston and connecting rod assemblies. (See Piston And Connecting Rod Removal And Installation on Page 70-90-1.)

Figure 70-90-16

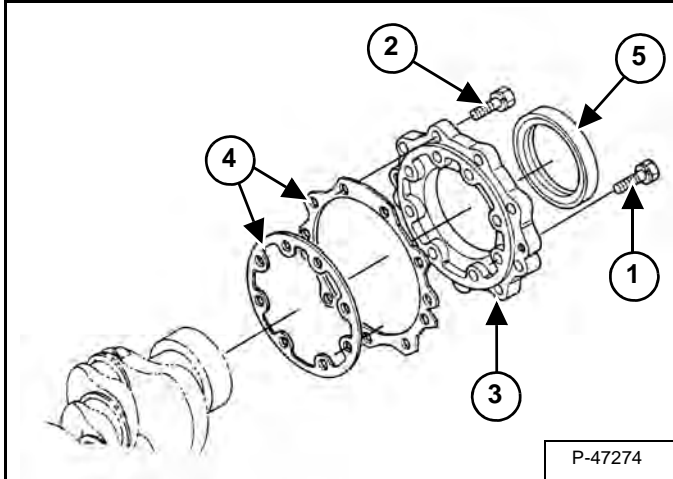

Mark and remove the inside screws (Item 1) first, then remove the outside screws (Item 2) [Figure 70-90-16].

NOTE: The inside bolts are different length than the outside bolts.

Install two screws in the bearing case cover and remove the cover (Item 3) [Figure 70-90-16].

Remove the two gaskets (Item 4) and oil seal (Item 5) [Figure 70-90-16] from the cover.

Figure 70-90-17

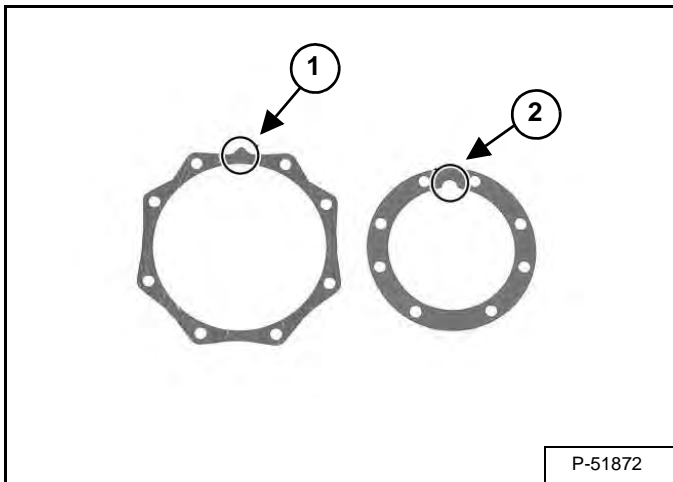

Installation: Install the gaskets (Items 1 and 2) [Figure 70-90-17] as shown.

Figure 70-90-18

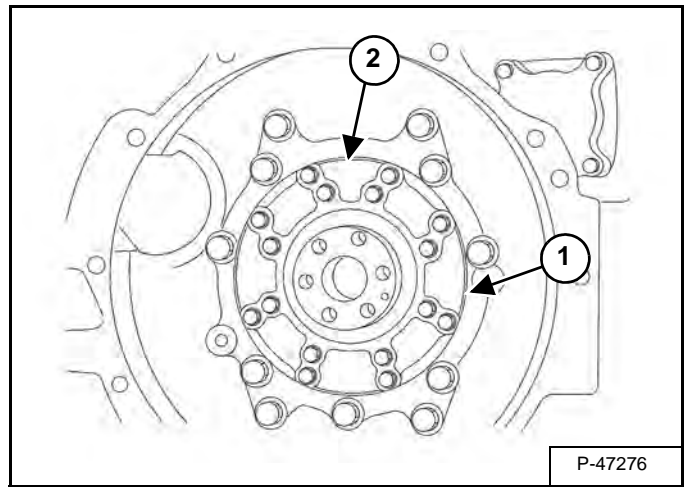

Install the bearing case cover (Item 1) [Figure 70-90-18] with the casting mark (Item 2) in the upward position. Tighten the bolts to 9,8 - 11,3 N•m (7.2 - 8.3 ft-lb) torque.

Figure 70-90-19

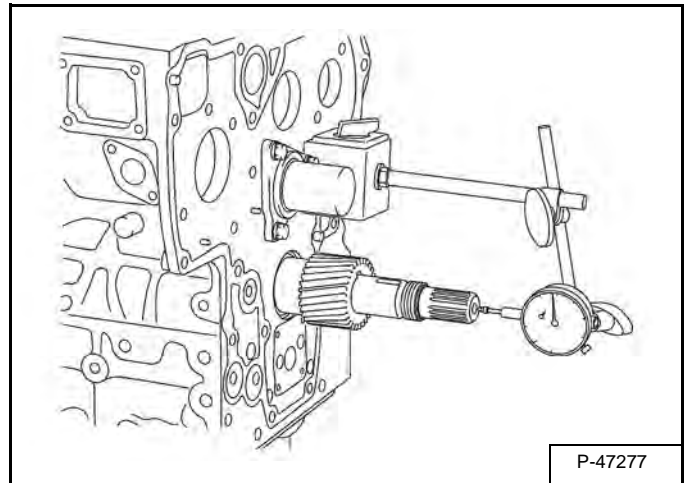

Before removing the crankshaft / main bearings, check the end play. Install a dial indicator. Move the crankshaft [Figure 70-90-19] to the flywheel side, zero the dial indicator. Measure the end play by pulling the crankshaft toward the gearcase side.

If the measurement exceeds the allowable limit, replace the thrust washers [Figure 70-90-19].

End Play	0,15 - 0,31 mm (0.0059 - 0.0122 in)
Allowable Limit	0,5 mm (0.020 in)

CRANKSHAFT AND PISTONS (CONT'D)

Crankshaft And Bearings Removal And Installation (Cont'd)

Figure 70-90-20

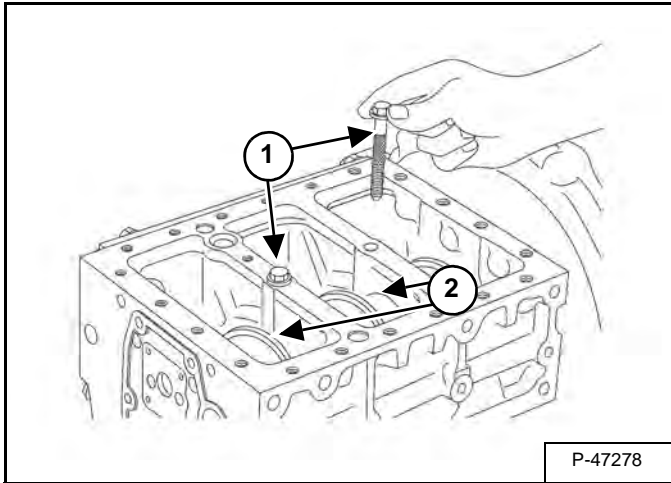

Remove the main bearing case bolt (Item 1) [Figure 70-90-20].

Installation: Align the bearing case hole (Item 2) [Figure 70-90-20] with the hole in the block. Put oil on the bolt threads and tighten to 49 - 53,9 N•m (36.2 - 39.8 ft-lb) torque.

Figure 70-90-21

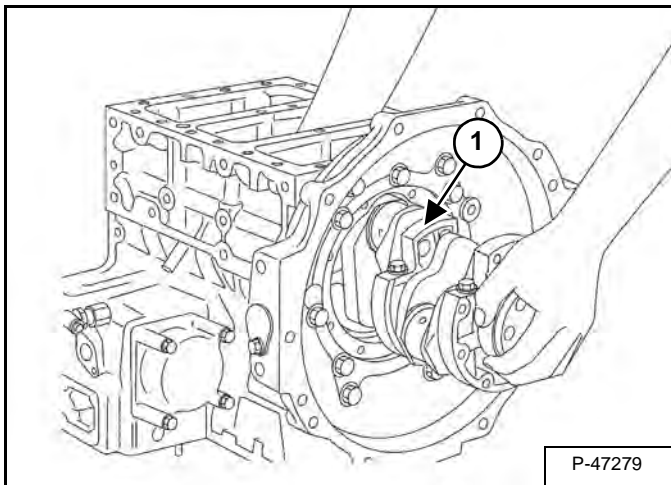

Remove the crankshaft / main bearing assembly from the engine block [Figure 70-90-21].

NOTE: Turn the crankshaft as needed to allow the crank pin journals to pass through the cut out (Item 1) [Figure 70-90-21] of the engine block.

Mark the bearing case halves for correct installation.

Figure 70-90-22

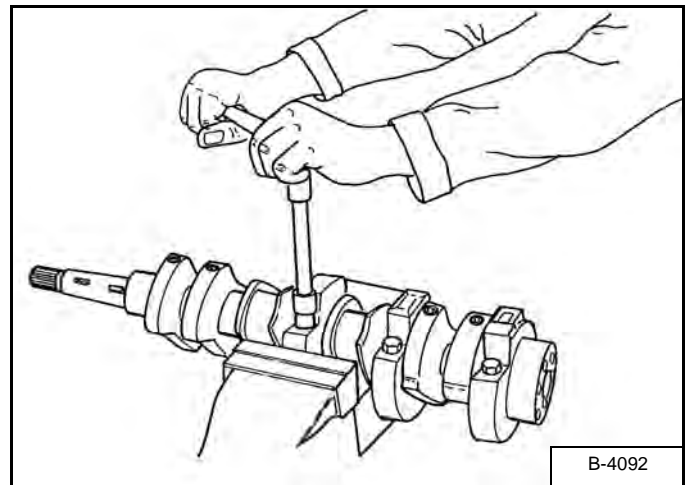

Remove the two bearing case bolts [Figure 70-90-22].

Remove the bearing case and bearing.

Installation: Tighten the bearing case bolts to 29,4 - 34,3 N•m (21.7 - 25.3 ft-lb) torque.

Figure 70-90-23

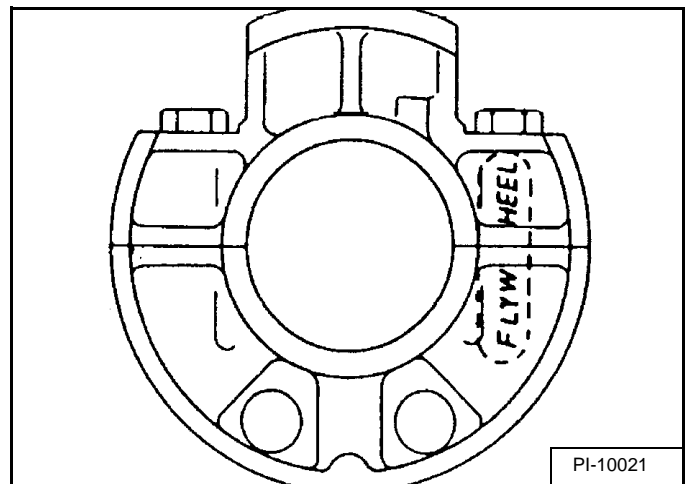

Installation: When installing the main bearing case assemblies, face the mark FLYWHEEL to the flywheel side of the engine block [Figure 70-90-23]. The thrust washers oil grooves must face outward.

CRANKSHAFT AND PISTONS (CONT'D)

Crankshaft And Bearings - Servicing

Figure 70-90-24

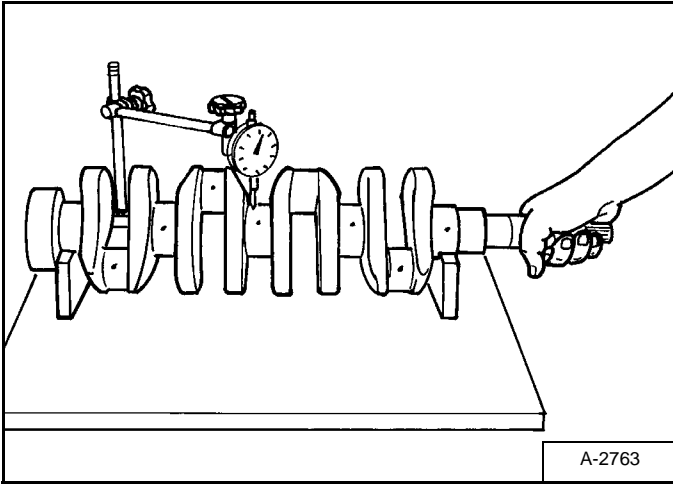

Put the crankshaft on V-blocks. Install a dial indicator on the center journal **[Figure 70-90-24]**.

Turn the crankshaft at a slow rate to obtain the misalignment (one half of the alignment measurement).

If the misalignment exceeds the allowable limit, replace the crankshaft.

Alignment 0,02 mm (0.0008 in)

Tighten the connecting rod bolts to 27 - 30 N•m (20 - 22 ft-lb) torque.

Figure 70-90-25

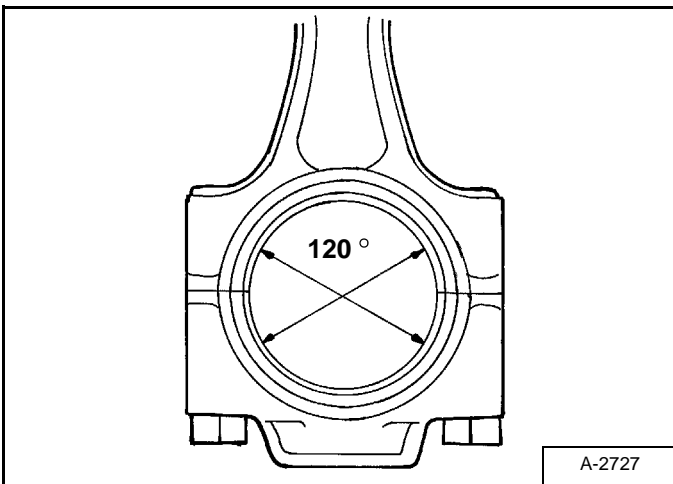

Measure the crankpin bearing I.D. **[Figure 70-90-25]**.

Figure 70-90-26

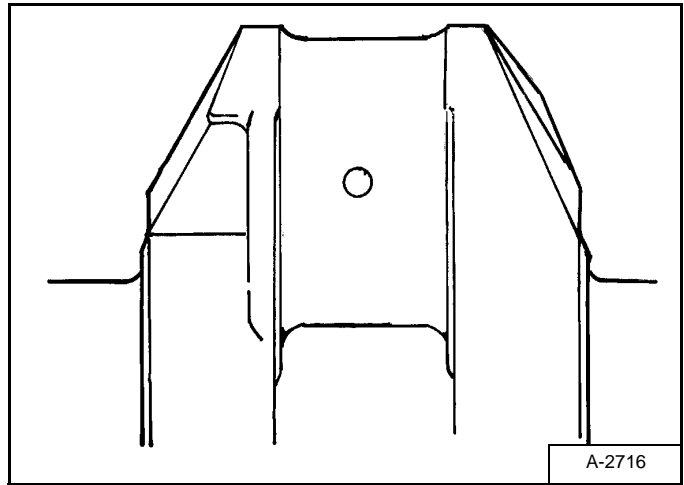

Measure the crankpin O.D. **[Figure 70-90-26]**.

Calculate the oil clearance.

Crankpin Bearing I.D.	40,004 - 40,050 mm (1.5764 - 1.5767 in)
Crankpin O.D.	39,959 - 39,975 mm (1.5732 - 1.5738 in)
Oil Clearance	0,029 - 0,091 mm (0.0012 - 0.0035 in)
Allowable limit	0,2 mm (0.0079 in)

CRANKSHAFT AND BEARINGS (CONT'D)

Crankshaft And Bearings - Servicing (Cont'd)

Figure 70-90-27

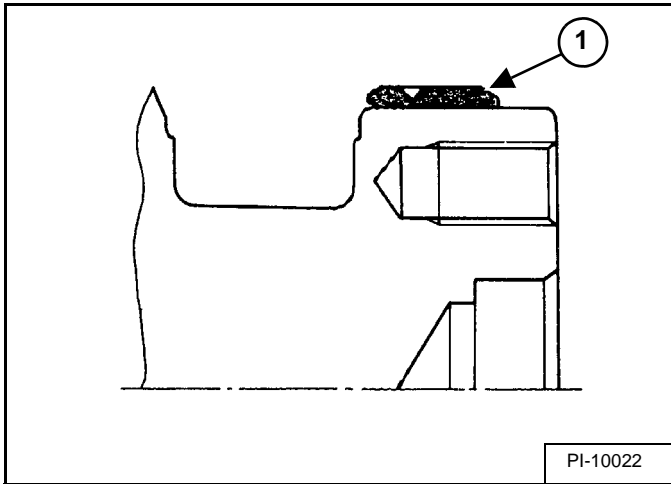

Check the wear on the crankshaft sleeve [Figure 70-90-27].

If the wear exceeds the allowable limit or the seal leaks oil, replace the sleeve.

Wear of Sleeve 0,1 mm (0.0004 in)

The special tool set will be needed to replace the crankshaft sleeve.

Remove the sleeve.

Figure 70-90-28

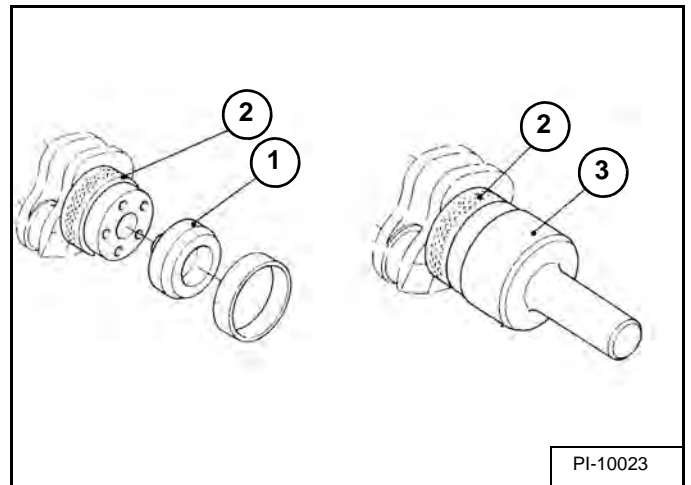

Install the sleeve guide (Item 1) and stop (Item 2) [Figure 70-90-28].

Heat the sleeve to approximately 150°C (300°F). Install the sleeve on the crankshaft using the special driver tool (Item 3) [Figure 70-90-28].

NOTE: The sleeve is installed with the larger chamfered surface to the front of the crankshaft (Item 1) [Figure 70-90-27].

CRANKSHAFT AND BEARINGS (CONT'D)

Crankshaft And Bearings - Servicing (Cont'd)

Figure 70-90-29

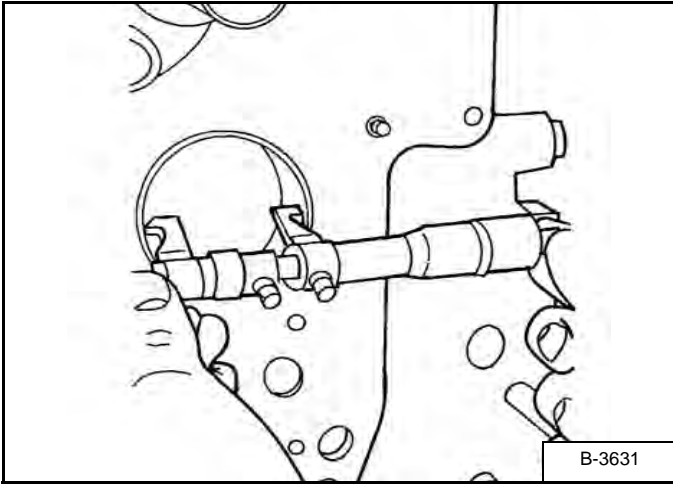

Measure the I.D. of the No. 1 crankshaft bearing [Figure 70-90-29].

Figure 70-90-30

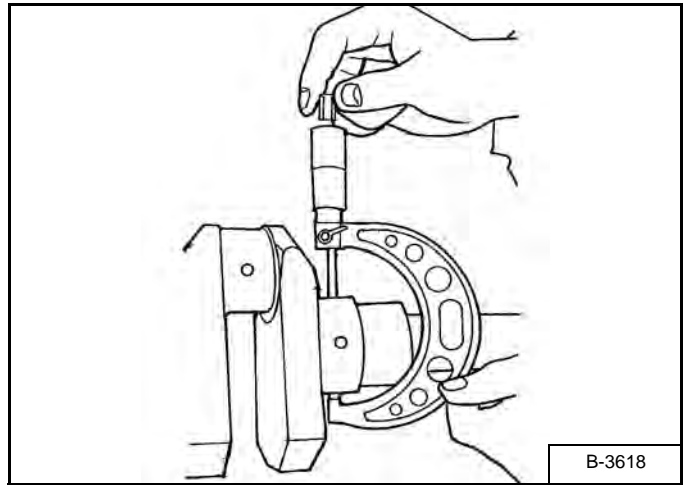

Measure the O.D. of the crankshaft journal [Figure 70-90-30].

Calculate the oil clearance.

If the clearance exceeds the allowable limit, replace the crankshaft bearing.

Bearing 1:

Bearing I.D.	47,984 - 48,048 mm (1.8892 - 1.8916 in)
Journal O.D.	49,934 - 49,950 mm (1.8872 - 1.8877 in)
Oil Clearance	0,034 - 0,114 mm (0.0013 - 0.0045 in)
Allowable Limit	0,2 mm (0.0079 in)

CRANKSHAFT AND PISTONS (CONT'D)

Crankshaft And Bearings - Servicing (Cont'd)

Figure 70-90-31

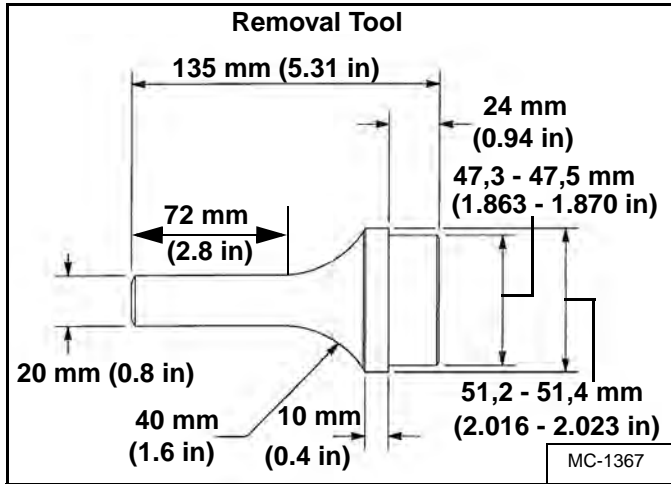

To remove the front bearing make the tool as shown in figure [Figure 70-90-31].

Figure 70-90-32

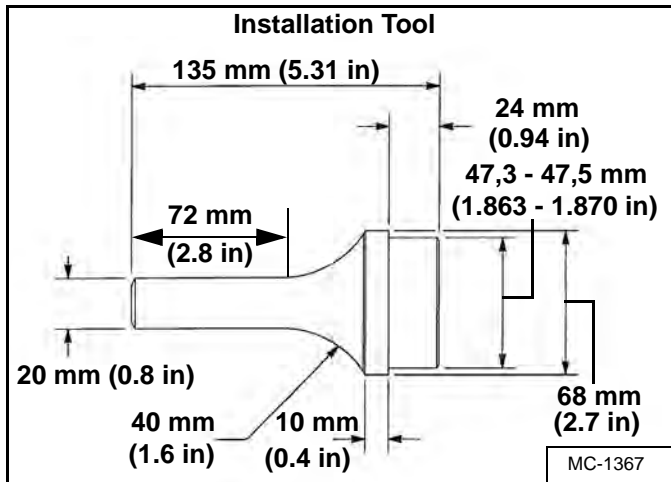

To install the front bearing make the tool as shown in figure [Figure 70-90-32].

Figure 70-90-33

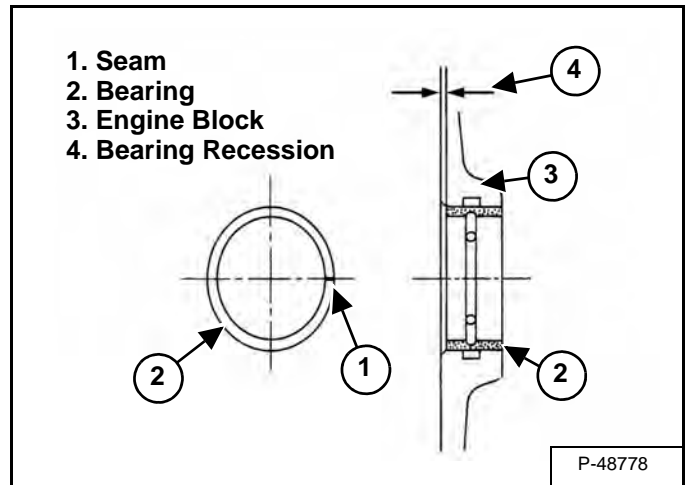

Remove the front bearing with the special removal tool [Figure 70-90-31].

Installation: Clean the new bearing (Item 2) and bore, apply oil to the bearing and bore. Install the new bearing with the seam (Item 1) [Figure 70-90-33] towards the exhaust manifold side, using the installation driver tool.

Check the depth (Item 4) of the bearing (Item 2) from the face of the engine block (Item 3) [Figure 70-90-33]. This will ensure proper bearing alignment with the crankshaft.

Bearing Number 1	0,0 - 0,3 mm
Recession	(0.0118 in)

Clean the crankshaft journal and bearing. Put a strip of press gauge on the center journal.

Install the main bearing case halves and tighten the bolts. Remove the bearing case halves.

NOTE: DO NOT turn the crankshaft with the press gauge installed. Incorrect measurements will be obtained.

CRANKSHAFT AND PISTONS (CONT'D)

Crankshaft And Bearings - Servicing (Cont'd)

Figure 70-90-34

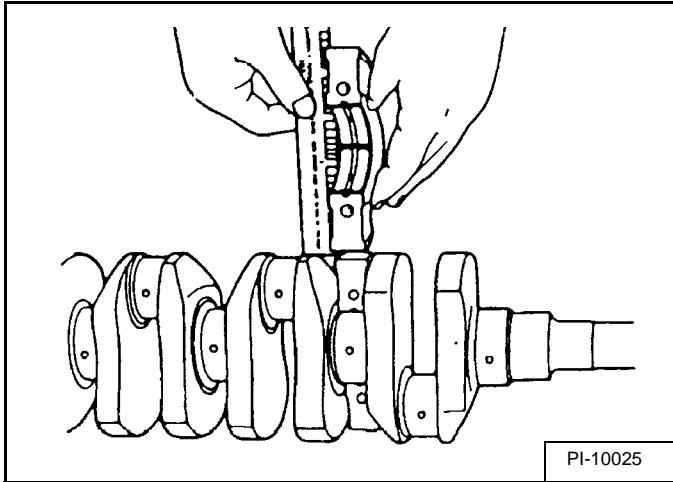

Measure the flattened press gauge [Figure 70-90-34].

If the clearance exceeds the allowable limit, replace the crankshaft bearing.

Crankshaft Bearing 2 and 3:

Crankshaft Journal O.D.	47,934 - 47,950 mm (1.8872 - 1.8878 in)
Bearing I.D.	47,984 - 48,029 mm (1.8891 - 1.8909 in)
Oil Clearance	0,034 - 0,095 mm (0.0013 - 0.0037 in)
Allowable Limit	0,2 mm (0.0079 in)

Crankshaft Bearing 4:

Crankshaft Journal O.D.	51,921 - 51,940 mm (2.0441 - 2.0449 in)
Bearing I.D.	51,974 - 52,019 mm (2.0462 - 2.0480 in)
Oil Clearance	0,034 - 0,098 mm (0.0013 - 0.0039 in)
Allowable Limit	0,2 mm (0.0079 in)

NOTE: Make sure you use the correct size bearing when installing. Oversize bearings are generally marked.

CAMSHAFT AND TIMING GEARS

Timing Gearcase Cover Removal And Installation

Remove the fuel injection pump. (See Fuel Injection Pump Removal And Installation on Page 70-70-9.)

Remove the governor fork lever. (See Governor Fork Lever Removal And Installation on Page 70-70-6.)

Figure 70-100-1

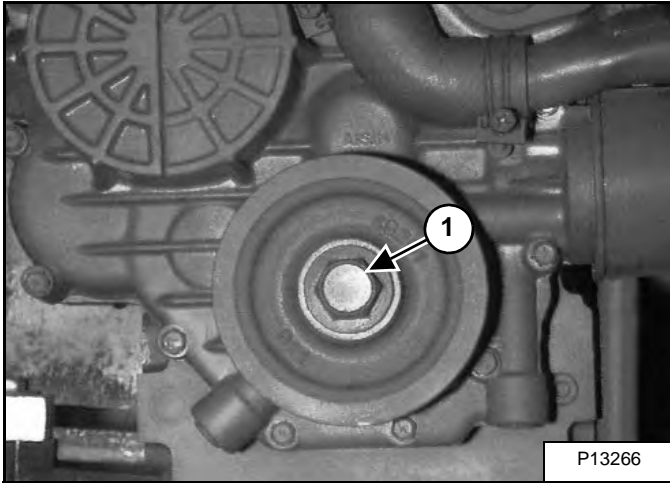

Remove the crankshaft pulley bolt (Item 1) [Figure 70-100-1].

Installation: Tighten crankshaft pulley bolt to 137 - 157 N•m (101 - 116 ft-lb) torque.

Figure 70-100-2

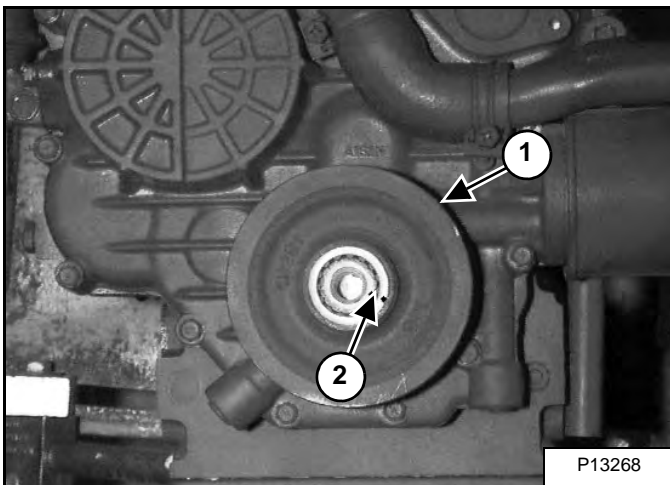

Remove the crankshaft pulley (Item 1) [Figure 70-100-2] from the crankshaft.

Installation: When installing the crankshaft pulley on the crankshaft, align the timing marks (Item 2) [Figure 70-100-2].

Figure 70-100-3

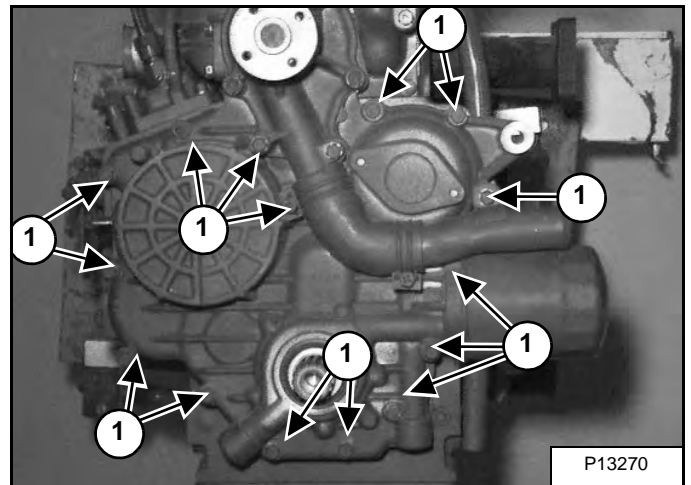

NOTE: The bolts may vary in length. Keep the bolts in their original location.

Remove the mounting bolts (Item 1) [Figure 70-100-3] from the timing gearcase cover, and remove the cover.

Installation: Tighten the mounting bolts to 10 - 11 N•m (7 - 8 in-lb) torque.

Clean the gasket surface of timing cover.

Figure 70-100-4

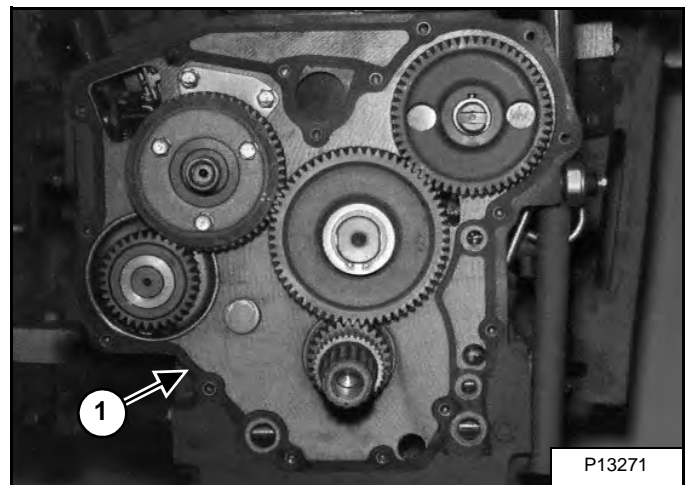

Remove the timing cover gasket (Item 1) [Figure 70-100-4].

CAMSHAFT AND TIMING GEARS (CONT'D)

Timing Gearcase Cover Removal And Installation (Cont'd)

Figure 70-100-5

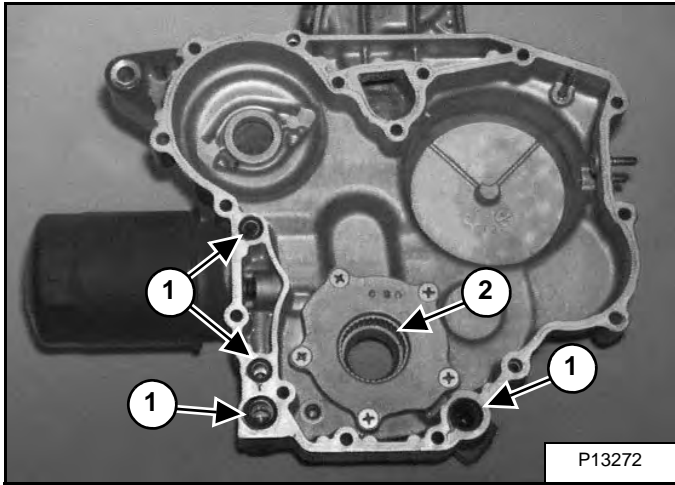

Installation: Install four new O-rings (Item 1) and the oil seal (Item 2) [Figure 70-100-5] into the timing gearcase cover.

Figure 70-100-6

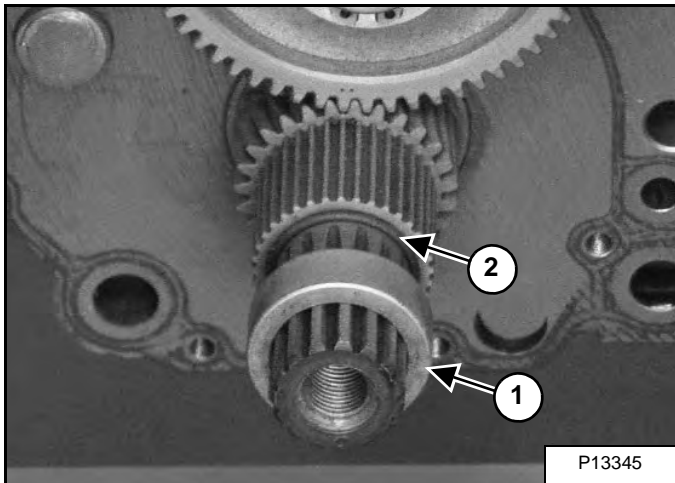

Remove the crankshaft collar (Item 1) [Figure 70-100-6] from the crankshaft.

NOTE: The collar may stay in the gearcase cover, when the cover is removed.

Remove the O-ring (Item 2) [Figure 70-100-6] from the crankshaft and replace with a new O-ring.

Figure 70-100-7

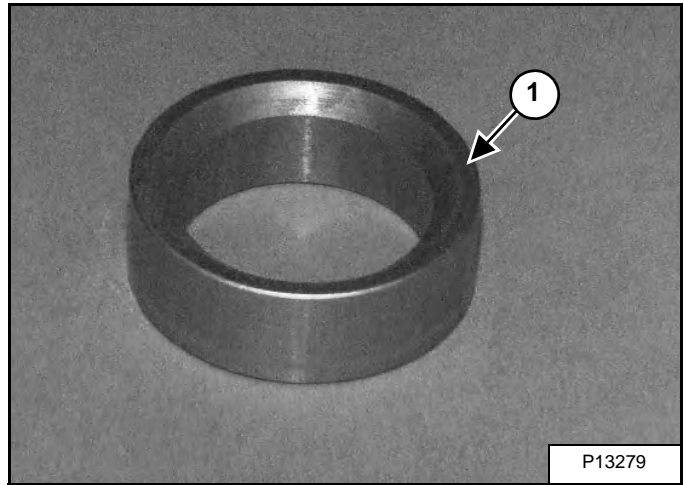

Installation: Install the timing gearcase cover, then install the crankshaft collar with the tapered side (Item 1) [Figure 70-100-7] toward the O-ring.

Figure 70-100-8

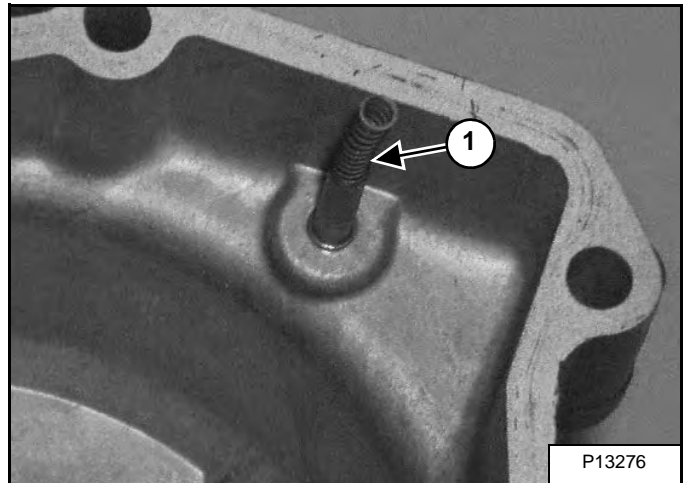

NOTE: The idle adjustment spring (Item 1) [Figure 70-100-8] is located inside the timing case cover. Be careful not to damage.

CAMSHAFT AND TIMING GEARS (CONT'D)

Timing Gears Backlash - Checking

When the gears are installed, check the backlash of the gears.

Figure 70-100-9

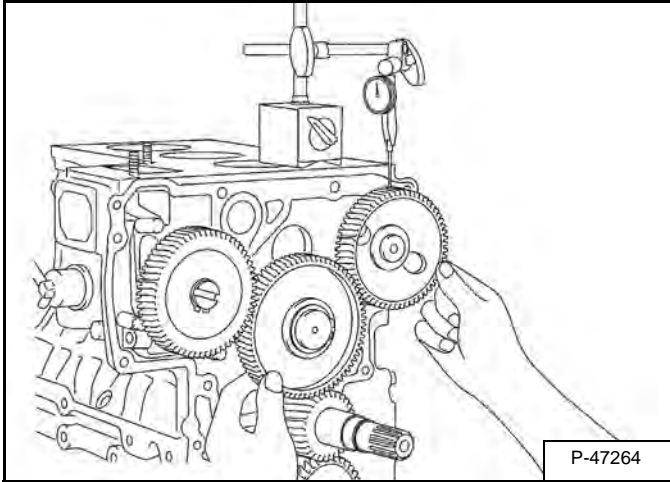

Install a dial indicator **[Figure 70-100-9]**.

Hold one gear while turning the other gear **[Figure 70-100-9]**.

If the backlash exceeds the allowable limit, check the oil clearance of the shaft and gear. If the oil clearance is correct, replace the gear.

Crank Gear and Idler Gear 1	0,032 - 0,115 mm (0.0013 - 0.0045 in)
Allowable Limit	0,15 mm (0.0059 in)
Cam Gear and Idler Gear 1	0,036 - 0,114 mm (0.0014 - 0.0045 in)
Allowable Limit	0,15 mm (0.0059 in)
Injection Pump Gear and Idler Gear 1	0,034 - 0,116 mm (0.0013 - 0.0046 in)
Allowable Limit	0,15 mm (0.0059 in)
Injection Pump Gear and Governor Gear	0,030 - 0,117mm (0.0012 - 0.0046 in)
Allowable Limit	0,15 mm (0.0059 in)

Idler Gear And Shaft Removal And Installation

Remove the timing gearcase cover. (See Timing Gearcase Cover Removal And Installation on Page 70-100-1.).

Figure 70-100-10

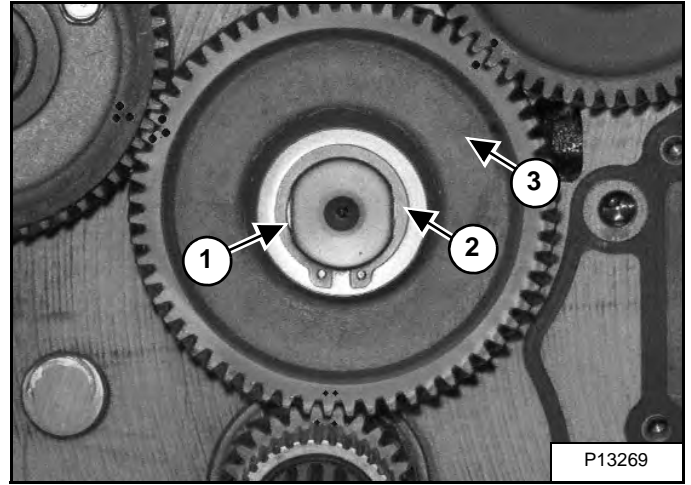

Remove the snap ring (Item 1) and flat washer (Item 2) from the idler gear shaft **[Figure 70-100-10]**.

Remove the idler gear (Item 3) **[Figure 70-100-10]**.

Figure 70-100-11

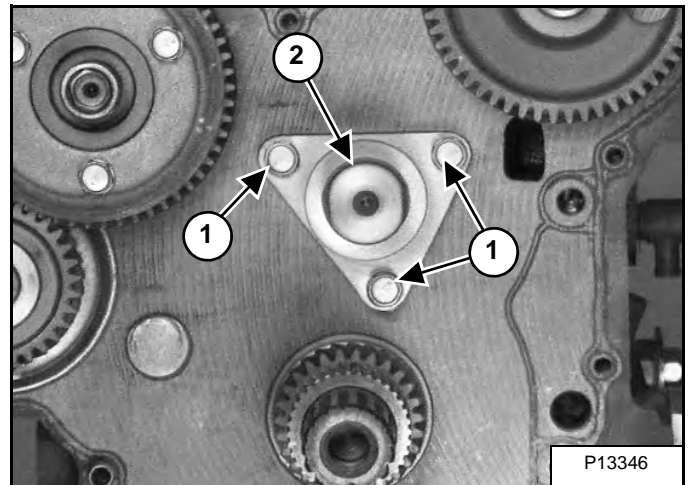

Remove the mounting bolts (Item 1) **[Figure 70-100-11]** from the idler shaft.

Remove the idler shaft (Item 2) **[Figure 70-100-11]**.

Installation: Tighten the camshaft retainer bolts to 18 - 21 N•m (14 - 15 ft-lb) torque.

CAMSHAFT AND TIMING GEARS (CONT'D)

Camshaft - Servicing

Remove the timing gearcase cover. (See Timing Gearcase Cover Removal And Installation on Page 70-100-1.)

Remove the cylinder head. (See Cylinder Head Removal And Installation on Page 70-80-3.)

Figure 70-100-12

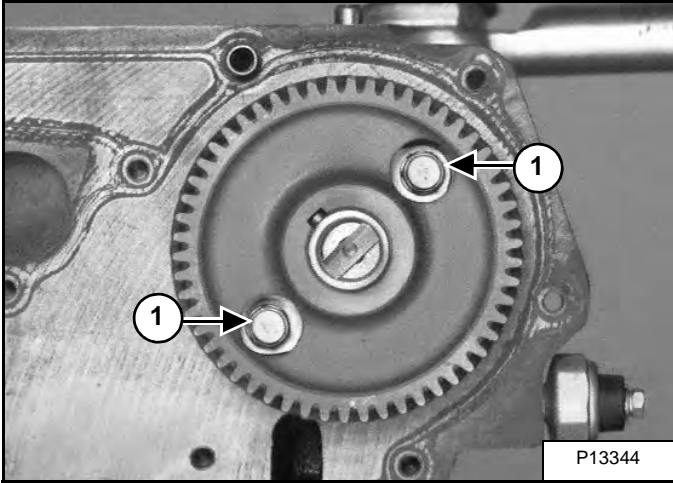

Remove the tappets from the block.

Align the holes (Item 1) [Figure 70-100-12] in the gear on the camshaft with the mounting plate bolts.

Remove the mounting bolts from the camshaft mounting plate.

Installation: Tighten the mounting bolts to 9,8 - 11,3 N•m (89 - 100 in-lb) torque.

Remove the camshaft.

Figure 70-100-13

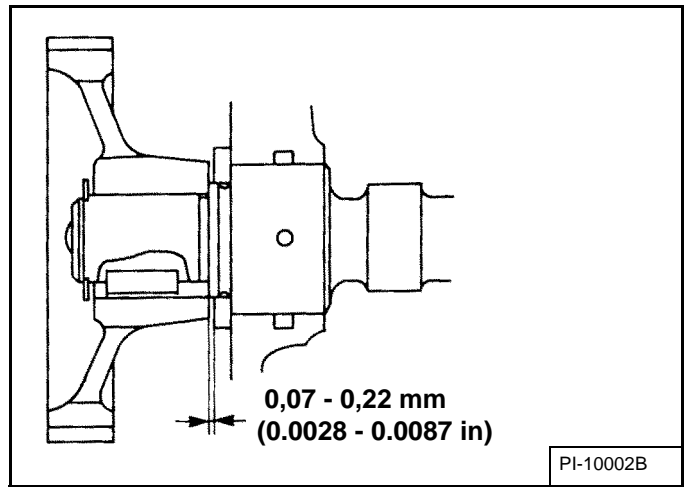

Installation: Check the camshaft end play. If clearance exceeds the allowable limit, replace the camshaft retainer plate [Figure 70-100-13].

Camshaft End Play	0,07 - 0,22 mm (0.0028 - 0.0087 in)
Allowable Limit	0,3 mm (0.012 in)

Figure 70-100-14

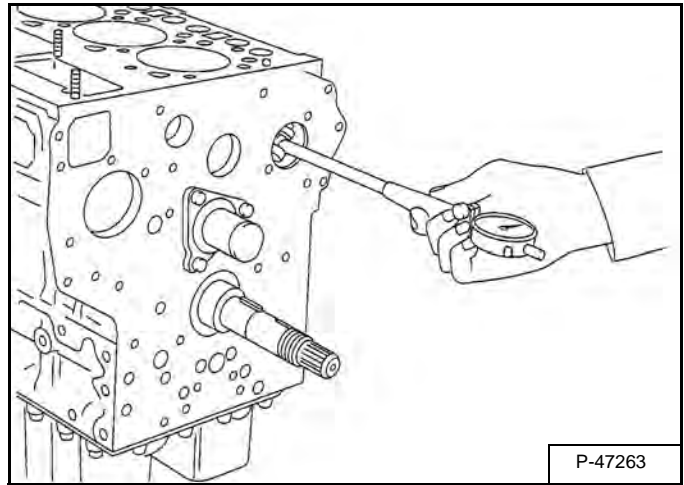

Measure the cylinder block bore in the engine block [Figure 70-100-14].

CAMSHAFT AND TIMING GEARS (CONT'D)

Camshaft - Servicing (Cont'd)

Figure 70-100-15

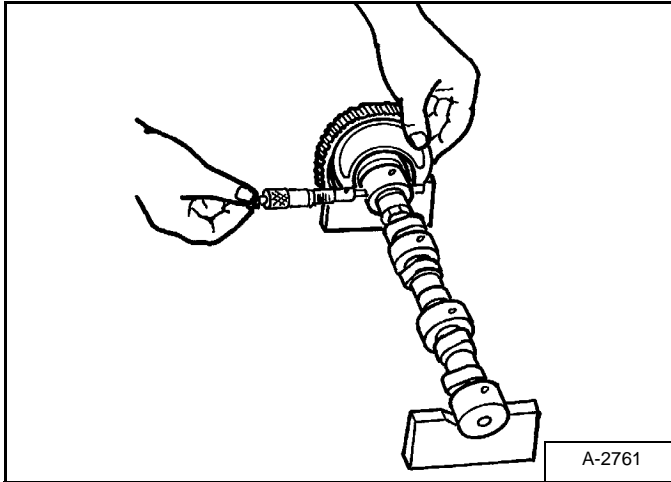

Measure the camshaft journal [Figure 70-100-15].

Calculate the oil clearance. If the clearance exceeds the allowable limit, replace the camshaft.

Cylinder Block Bore I.D.	36 - 36,025 mm (1.4173 - 1.4183 in)
Journal O.D.	35,934 - 35,950 mm (1.4147 - 1.4153 in)
Oil Clearance of Camshaft Journal	0,05 - 0,091 mm (0.0020 - 0.0035 in)
Allowable Limit	0,15 mm (0.0059 in)

Figure 70-100-16

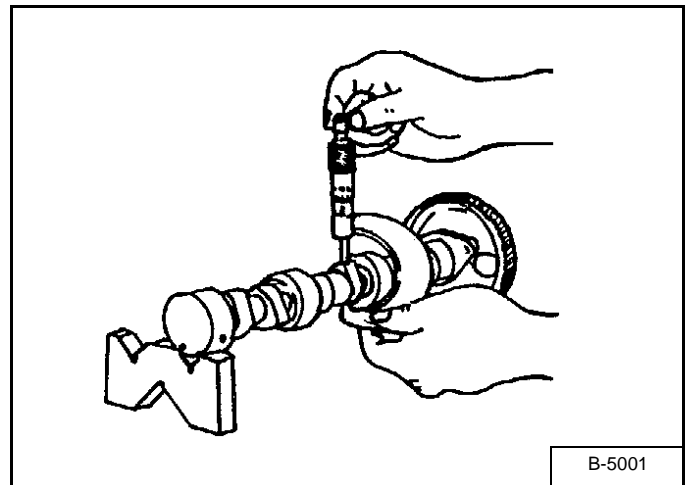

Measure the cam lobes at their highest point [Figure 70-100-16].

If the measurement is less than the allowable limit, replace the camshaft.

Cam Height of Intake	28,8 mm (1.134 in)
Allowable Limit	28,75 mm (1.132 in)
Cam Height of Exhaust	29 mm (1.142 in)
Allowable Limit	28,95 mm (1.140 in)

Figure 70-100-17

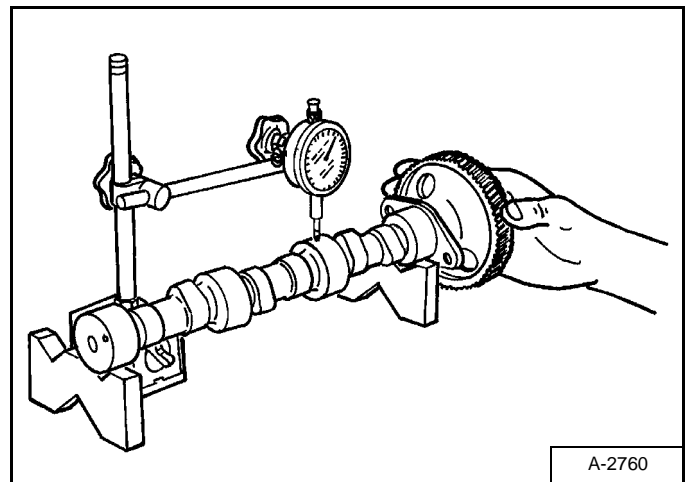

Put the camshaft in V-blocks. Install a dial indicator [Figure 70-100-17].

Turn the camshaft at a slow rate. If the misalignment exceeds the allowable limit, replace the camshaft.

Camshaft Alignment Allowable Limit	0,01 mm (0.0004 in)
------------------------------------	------------------------

CAMSHAFT AND TIMING GEARS (CONT'D)

Idler Gear And Shaft Servicing

Figure 70-100-18

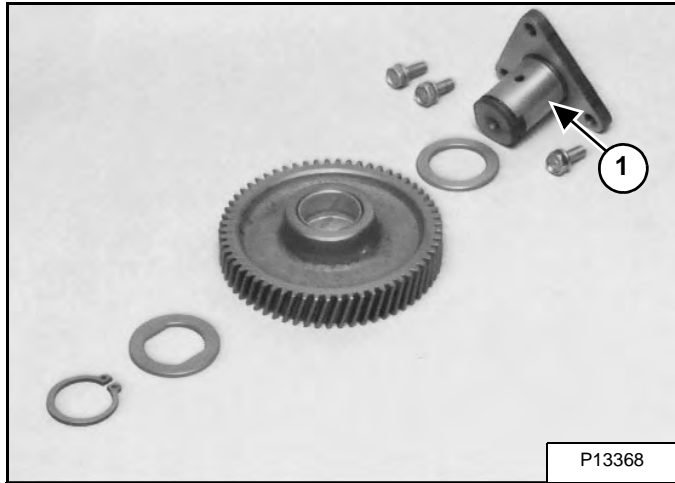

Measure the outside diameter of the idler gear shaft (Item 1) [Figure 70-100-18].

Idler Gear Shaft O.D.	25,967 - 25,98 mm (1.0223 - 1.0228 in)
-----------------------	---

Figure 70-100-19

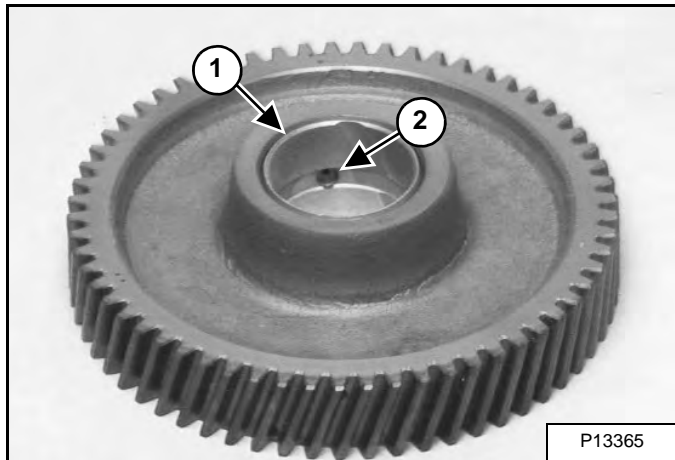

Check the inside diameter of the idler gear bushing (Item 1) [Figure 70-100-19].

Idler Gear Bushing I.D.	26,000 - 26,021 mm (1.0237 - 1.0244 in)
Oil Clearance Between Idler Gear and Bushing	0,020 - 0,054 mm (0.0008 - 0.0021 in)
Allowable limit	0,10 mm (0.0039 in)

If the clearance exceeds the allowable limit, replace the bushing.

Align the oil hole in the bushing (Item 2) [Figure 70-100-19] with oil hole in the gear, when installing the new bushing.

Figure 70-100-20

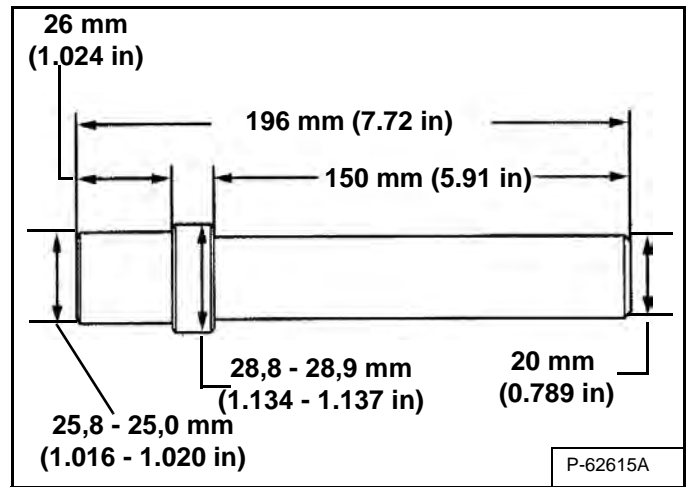

To replace the idler gear bushing, make a driver tool as shown in figure [Figure 70-100-20].

Figure 70-100-21

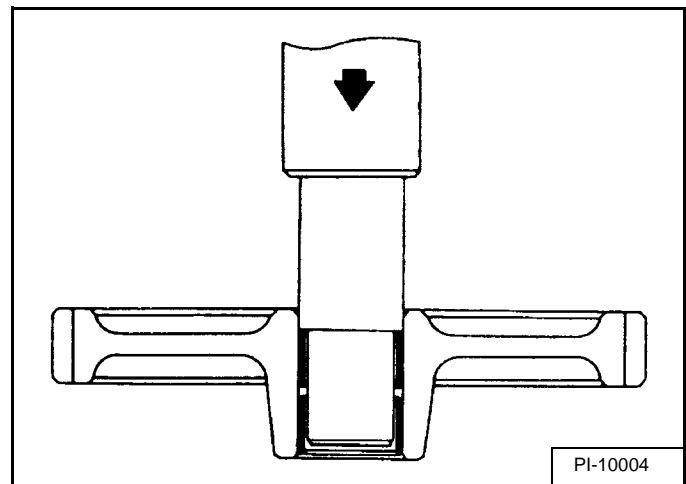

Use a press and the driver tool, to remove the old bushing and install the new bushing [Figure 70-100-21].

FLYWHEEL AND HOUSING

Flywheel Removal And Installation

Remove the engine and hydrostatic pump assembly from the loader. (See Engine Removal And Installation on Page 70-10-9.)

Remove the drive belt. (See Belt Removal And Installation on Page 30-50-1.)

Figure 70-110-1

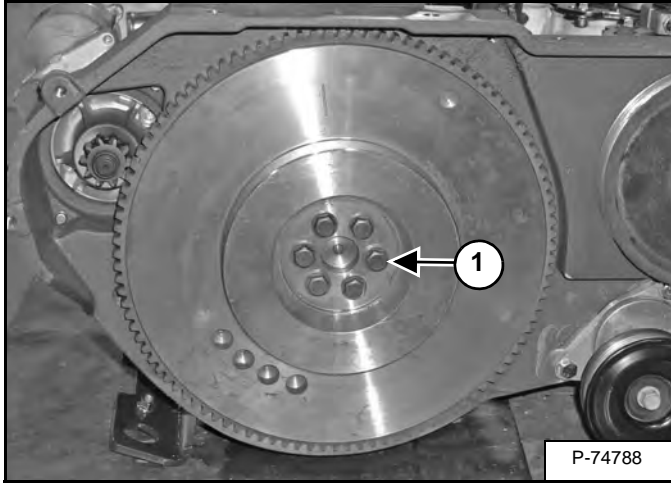

Remove the six bolts (Item 1) [Figure 70-110-1] from the flywheel.

Remove the flywheel.

Installation: Coat the threads with a thread locking adhesive Loctite® 242 or equivalent. Tighten the bolts to 54 - 59 N•m (40 - 43 ft-lb) torque.

Ring Gear Removal And Installation

Figure 70-110-2

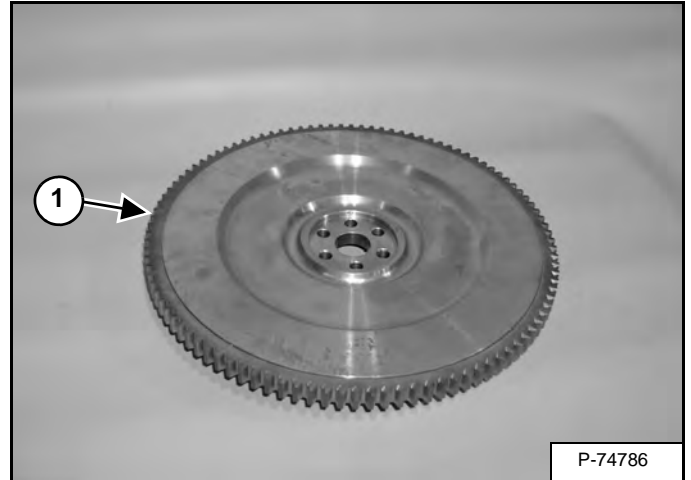

The ring gear (Item 1) [Figure 70-110-2] on the flywheel is an interference fit. Heat the ring gear enough to expand the gear. Hit the ring gear evenly around the gear to remove it from the flywheel.

Clean the outer surface of the flywheel thoroughly so the new ring gear will fit smoothly onto the flywheel.

Clean the new ring gear and heat it to a temperature of 232° - 260°C (450° - 500°F)

Fit the ring gear on the flywheel and be sure the gear is seated correctly.

FLYWHEEL AND HOUSING (CONT'D)

Housing Removal And Installation

Remove the starter. (See Removal And Installation on Page 60-40-3.)

Remove the hydrostatic pump. (See Removal And Installation on Page 30-40-2.)

Remove the tensioner pulley. (See Tensioner Pulley Removal And Installation on Page 30-50-2.)

Figure 70-110-3

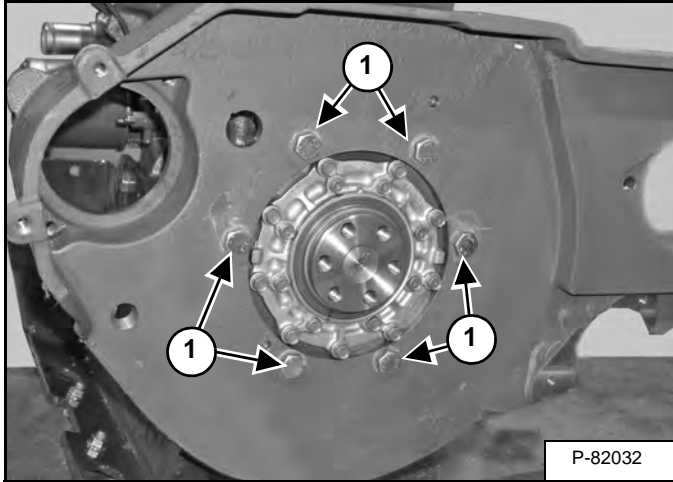

Remove the flywheel.

Remove the bolts (Item 1) [Figure 70-110-3] from the housing.

Installation: Tighten the bolts to 39 - 45 N•m (29 - 33 ft-lb) torque.

Remove the housing.

HEATER

HEATER SYSTEM	80-10-1
Description	80-10-1
REGULAR MAINTENANCE (S/N A3W611001 - A3W613399 AND A3W711001 - A3W713235)	80-20-1
Heater Coil	80-20-1
REGULAR MAINTENANCE (S/N A3W613400 & ABOVE, A3W713236 & ABOVE, B38V11001 & ABOVE, B38W11001 & ABOVE, B4TY11001 & ABOVE AND B4UC11001 & ABOVE)	80-21-1
Heater Coil	80-21-1
TROUBLESHOOTING	80-30-1
Electric System	80-30-1
Heater Valve Not Opening Or Closing	80-30-1
Blower Motor Does Not Operate	80-30-1
Blower Motor Operates Normally, But Air Flow Is Insufficient	80-30-1
HEATER UNIT (S/N A3W611001 - A3W613399 AND A3W711001 - A3W713235) ...	80-40-1
Removal And Installation	80-40-1
HEATER UNIT (S/N A3W613400 & ABOVE, A3W713236 & ABOVE, B38V11001 & ABOVE, B38W11001 & ABOVE, B4TY11001 & ABOVE AND B4UC11001 & ABOVE)	80-41-1
Removal And Installation	80-41-1
HEATER COIL (S/N A3W611001 - A3W613399 AND A3W711001 - A3W713235) ...	80-50-1
Removal And Installation	80-50-1
HEATER COIL (S/N A3W613400 & ABOVE, A3W713236 & ABOVE, B38V11001 & ABOVE, B38W11001 & ABOVE, B4TY11001 & ABOVE AND B4UC11001 & ABOVE)	80-51-1
Removal And Installation	80-51-1
HEATER FAN (S/N A3W611001 - A3W613399 AND A3W711001 - A3W713235)	80-60-1
Removal And Installation	80-60-1
HEATER FAN (S/N A3W613400 & ABOVE, A3W713236 & ABOVE, B38V11001 & ABOVE, B38W11001 & ABOVE, B4TY11001 & ABOVE AND B4UC11001 & ABOVE)	80-61-1
Removal And Installation	80-61-1
HEATER VALVE (S/N A3W611001 - A3W613399 AND A3W711001 - A3W713235)	80-70-1
Removal And Installation	80-70-1
HEATER VALVE (S/N A3W613400 & ABOVE, A3W713236 & ABOVE, B38V11001 & ABOVE, B38W11001 & ABOVE, B4TY11001 & ABOVE AND B4UC11001 & ABOVE)	80-71-1
Removal And Installation	80-71-1

HEATER SWITCH (S/N A3W611001 - A3W613399 AND A3W711001 - A3W713235)	80-80-1
Removal And Installation	80-80-1
Checking	80-80-2

HEATER SWITCH (S/N A3W613400 & ABOVE, A3W713236 & ABOVE, B38V11001 & ABOVE, B38W11001 & ABOVE, B4TY11001 & ABOVE AND B4UC11001 & ABOVE)	80-81-1
Removal And Installation	80-81-1
Checking	80-81-2

HEATER SYSTEM

Description

The heater is located on the left side of the operator seat. The heater uses engine coolant to warm the air which is delivered by the blower, into the cab area. The heater contains a heater coil, and blower. The heater has a temperature control valve and a three speed blower control switch.



Bobcat®

**REGULAR MAINTENANCE (S/N A3W611001 -
A3W613399 AND A3W711001 - A3W713235)**

Heater Coil

Remove the heater from the loader. (See Removal And Installation on Page 80-40-1.)

Remove the coil from the heater. (See Removal And Installation on Page 80-50-1.)

Figure 80-20-1

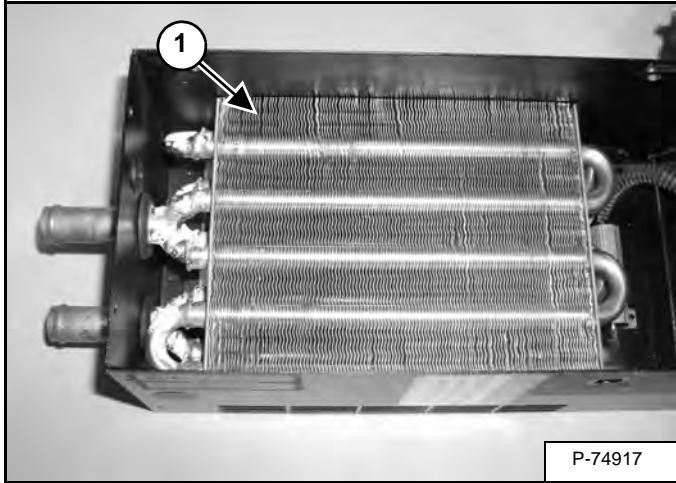

Clean the coil using low water pressure or low air pressure. The fins (Item 1) **[Figure 80-20-1]** can bend easily, use care when cleaning the fins.



Bobcat®

REGULAR MAINTENANCE (S/N A3W613400 & ABOVE, A3W713236 & ABOVE, B38V11001 & ABOVE, B38W11001 & ABOVE, B4TY11001 & ABOVE AND B4UC11001 & ABOVE)

Heater Coil

Remove the heater from the loader. (See Removal And Installation on Page 80-41-1.)

Remove the coil from the heater. (See Removal And Installation on Page 80-51-1.)

Figure 80-21-1

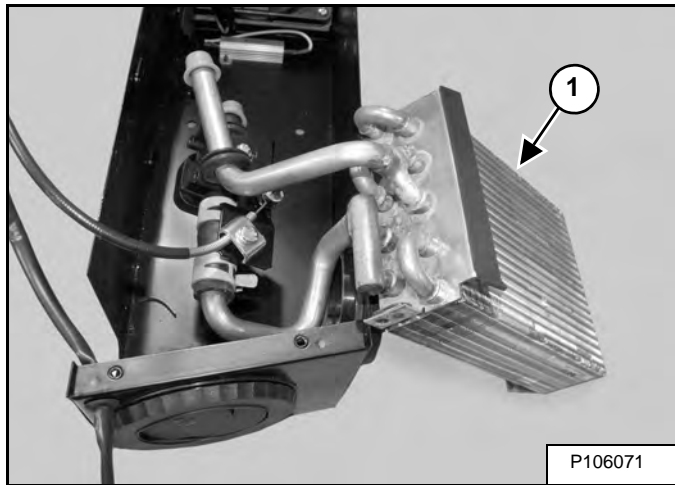

Clean the coil using low water pressure or low air pressure. The fins (Item 1) **[Figure 80-21-1]** can bend easily, use care when cleaning the fins.



Bobcat®

TROUBLESHOOTING

Electric System

Possible Cause	Inspection	Solution
1. Blown fuse.	Inspect the fuse / wiring.	Replace the fuse / repair wiring.
2. Broken wiring or bad connection.	Check the fan motor ground and connectors.	Repair the wiring or connector.
3. Switch defective	Check the switch.	Replace the switch.

Heater Valve Not Opening Or Closing

Possible Cause	Inspection	Solution
1. Valve defective.	Inspect the valve.	Repair or replace the valve.
2. Valve dirty or plugged.	Inspect the valve for debris.	Clean the valve.

Blower Motor Does Not Operate

Possible Cause	Inspection	Solution
1. Blown fuse.	Inspect the fuse / wiring.	Replace fuse / repair wiring.
2. Broken wiring or bad connection.	Check the fan motor ground and connectors.	Repair the wiring or connector.
3. Fan motor malfunction.	Check the lead wires from the motor with a circuit tester.	Replace Motor.
4. Resistor malfunction.	Check resistor using a circuit tester.	Replace Resistor.
5. Fan motor switch malfunction.	Check power into and out of the fan switch.	Replace Fan Switch.
6. Fan motor is obstructed.	Check the blower for obstruction.	Remove the obstruction.

Blower Motor Operates Normally, But Air Flow Is Insufficient

Possible Cause	Inspection	Solution
1. Coil dirty or plugged.	Check coil for obstruction.	Remove obstruction and clean with air or water.
2. Blower is obstructed.	Check the blower for obstruction.	Remove the obstruction.



Bobcat®

HEATER UNIT (S/N A3W611001 - A3W613399 AND A3W711001 - A3W713235)

Removal And Installation

Raise the operator cab. (See Raising on Page 10-30-2.)

Figure 80-40-1

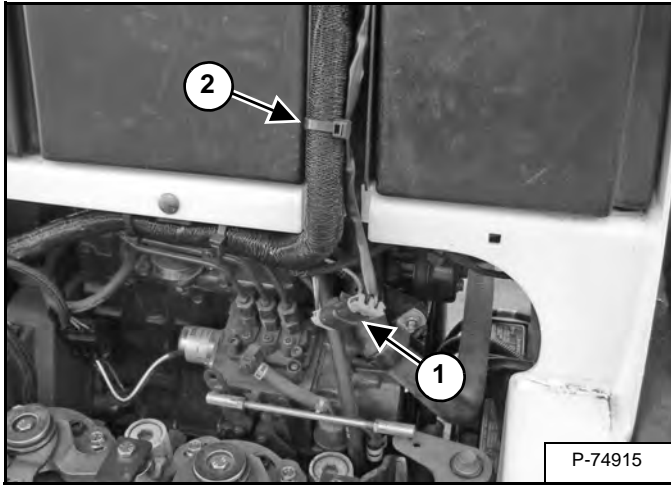

Disconnect the heater harness connector (Item 1) [Figure 80-40-1] from the main harness.

Remove the tie strap (Item 2) [Figure 80-40-1].

Figure 80-40-2

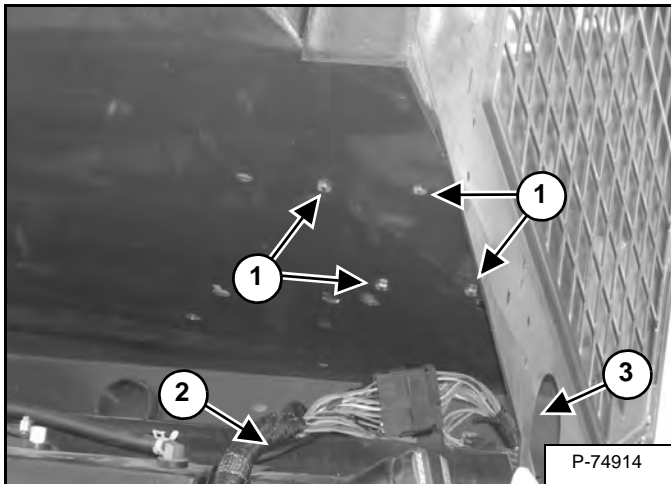

Remove the four bolts (Item 1) [Figure 80-40-2] which secure the heater unit to the back of the cab.

Pull the heater harness (Item 2) away from the fuel tank and out the opening (Item 3) [Figure 80-40-2].

Lower the cab. (See Lowering on Page 10-30-3.)

Figure 80-40-3

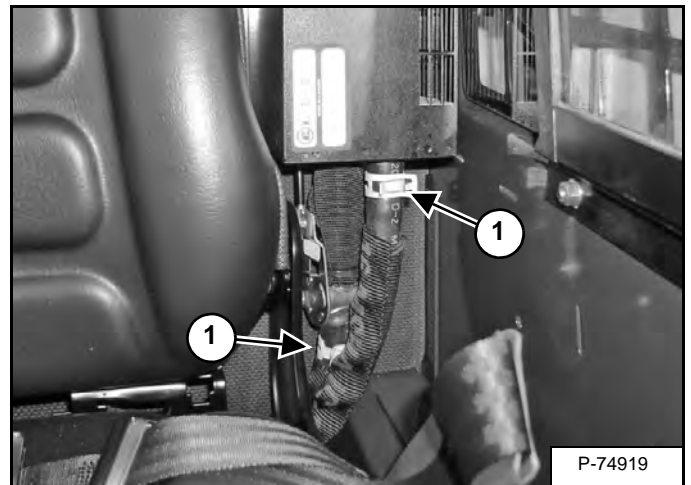

Loosen the clamps (Item 1) [Figure 80-40-3] and remove the hoses. Plug the hoses after removal.

Remove the heater unit from the cab.

NOTE: Some coolant will be lost during hose removal.



Bobcat®

HEATER UNIT (S/N A3W613400 & ABOVE,
A3W713236 & ABOVE, B38V11001 & ABOVE,
B38W11001 & ABOVE, B4TY11001 & ABOVE AND
B4UC11001 & ABOVE)

Removal And Installation

Raise the operator cab. (See Raising on Page 10-30-2.)

Figure 80-41-1

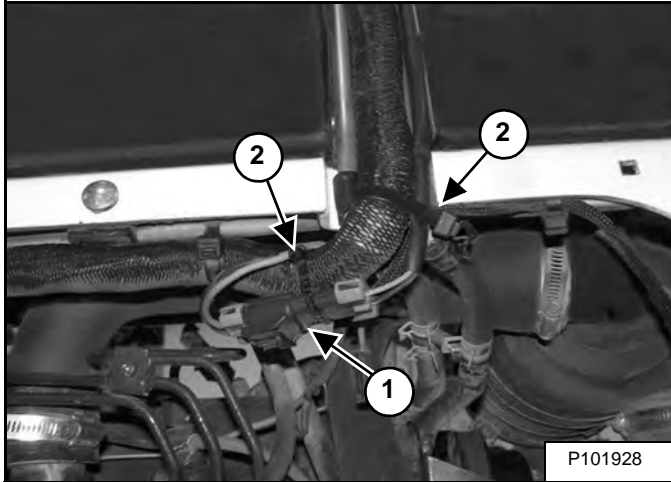

Disconnect the heater harness connector (Item 1) from the main harness. Remove the tie straps (Item 2) [Figure 80-41-1].

Figure 80-41-2

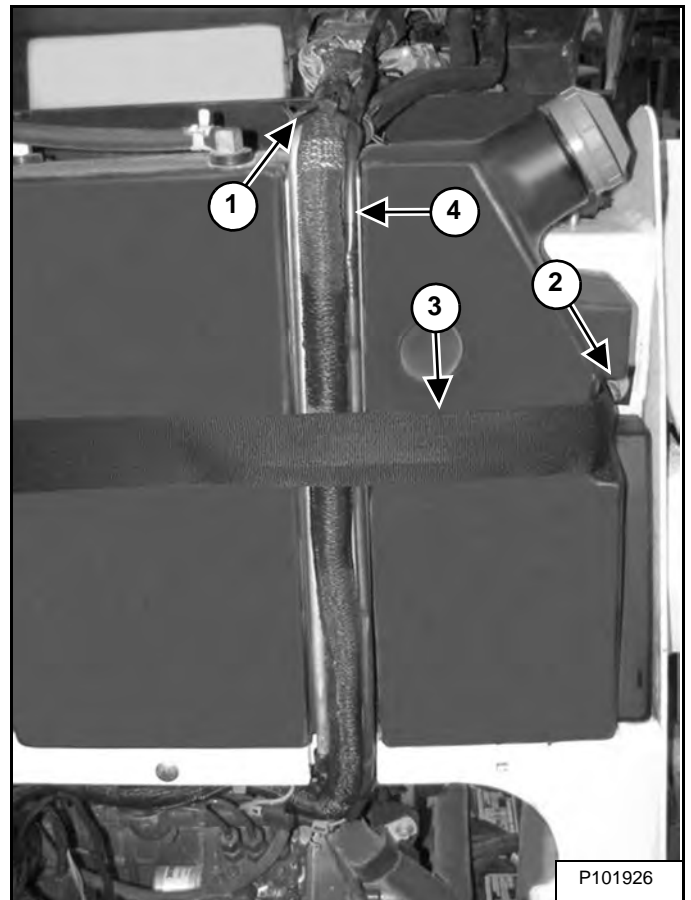

Remove the tie strap (Item 1) [Figure 80-41-2]. Loosen the nut (Item 2) on the fuel tank strap (Item 3) and pull the heater harness (Item 4) [Figure 80-41-2] away from the fuel tank.

**HEATER UNIT (S/N A3W613400 & ABOVE,
A3W713236 & ABOVE, B38V11001 & ABOVE,
B38W11001 & ABOVE, B4TY11001 & ABOVE AND
B4UC11001 & ABOVE) (CONT'D)**

Removal And Installation (Cont'd)

Figure 80-41-3

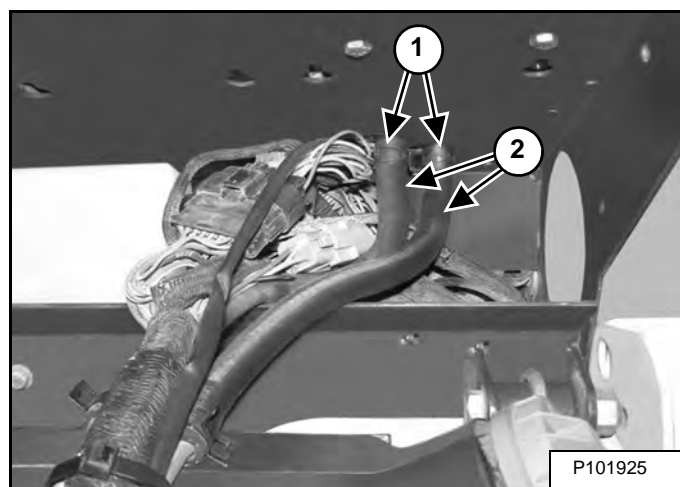

Loosen the clamps (Item 1) and remove the hoses (Item 2) [Figure 80-41-3].

NOTE: Plug the hoses and cap the fittings.

NOTE: Some coolant will be lost during hose removal.

Figure 80-41-4

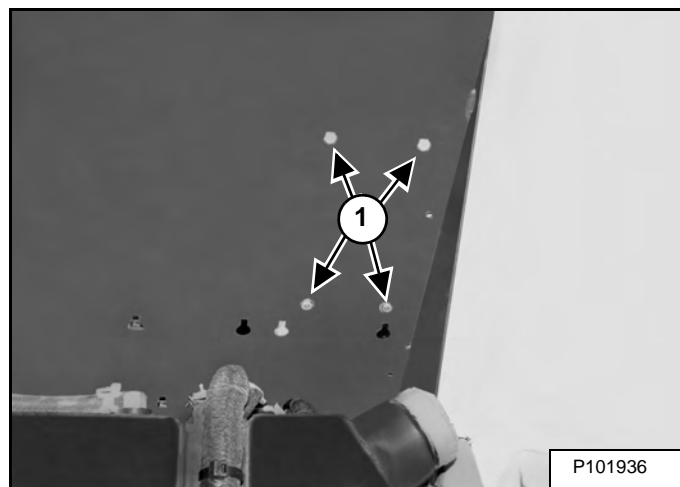

Remove the four bolts (Item 1) [Figure 80-41-4].

Remove the heater unit from the cab.

HEATER COIL (S/N A3W611001 - A3W613399 AND A3W711001 - A3W713235)

Removal And Installation

Remove the heater assembly from the loader. (See Removal And Installation on Page 80-40-1.)

Figure 80-50-1

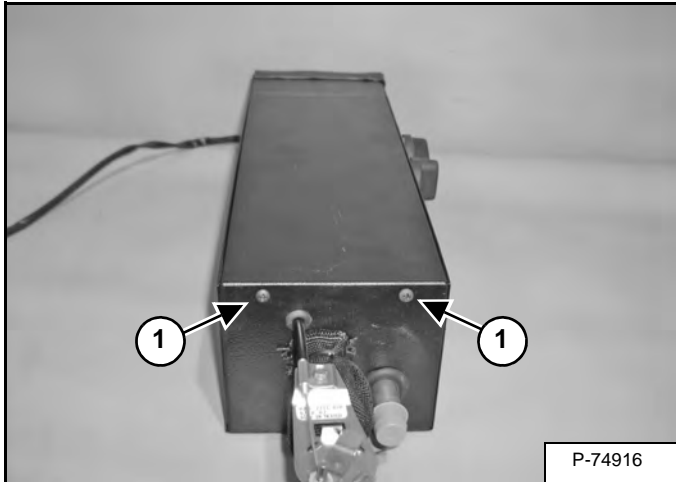

Remove the two screws (Item 1) [Figure 80-50-1] from the bottom of the heater unit.

Figure 80-50-2

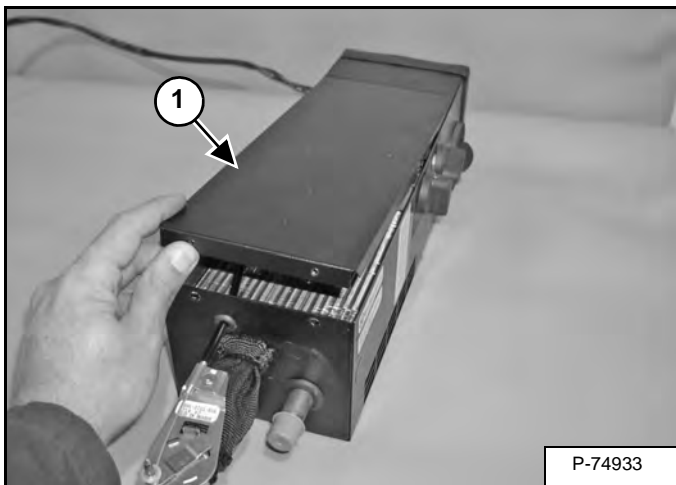

Remove the cover (Item 1) [Figure 80-50-2] from the heater unit.

Figure 80-50-3

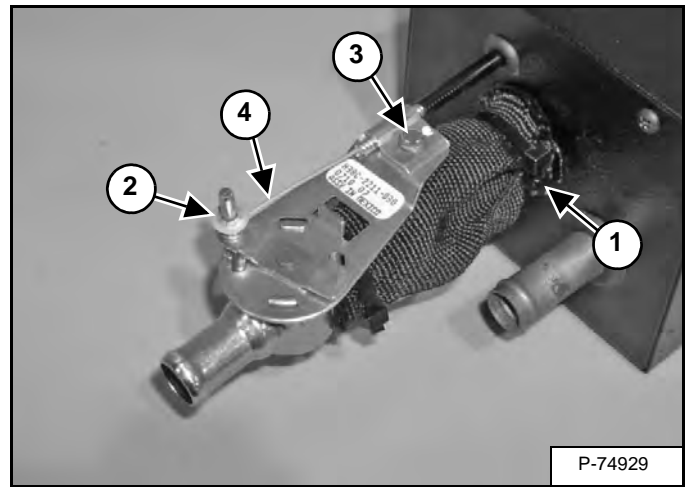

Remove the tie strap (Item 1) [Figure 80-50-3].

Remove the keeper washer (Item 2) and loosen the screw (Item 3) [Figure 80-50-3].

Slide the cable (Item 4) [Figure 80-50-3] off the post.

Figure 80-50-4

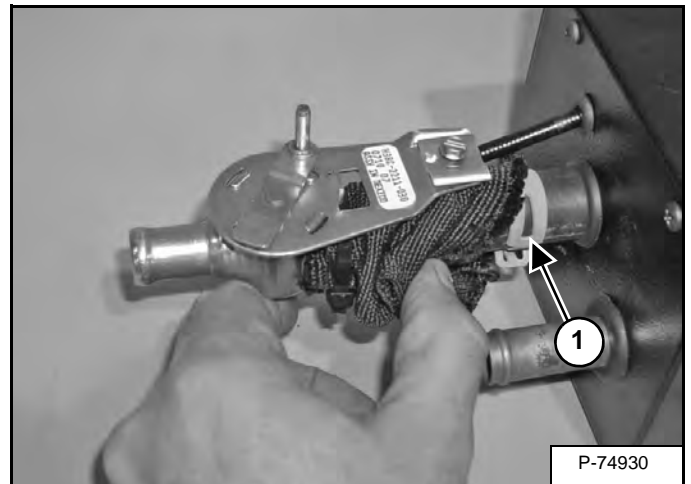

Loosen the clamp (Item 1) [Figure 80-50-4] then remove the heater valve.

HEATER COIL (S/N A3W611001 - A3W613399 AND A3W711001 - A3W713235) (CONT'D)

Removal And Installation (Cont'd)

Figure 80-50-5

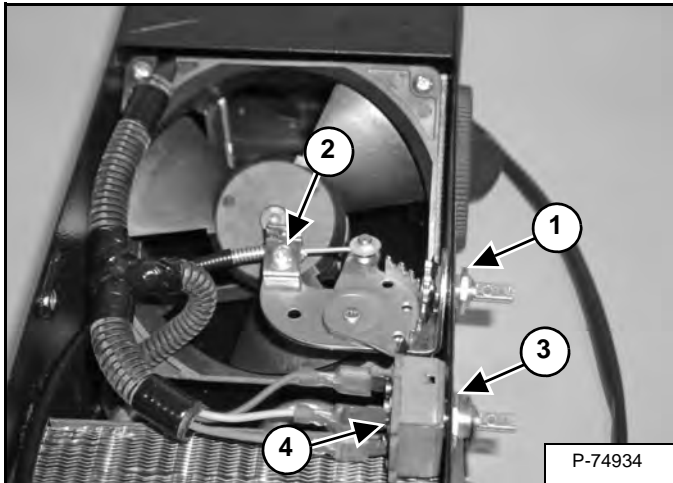

Remove the nut (Item 1) then remove the coolant flow adjuster (Item 2) [Figure 80-50-5] from the heater assembly.

Remove the nut (Item 3) then move the heater switch (Item 4) [Figure 80-50-5] out of the way.

Figure 80-50-6

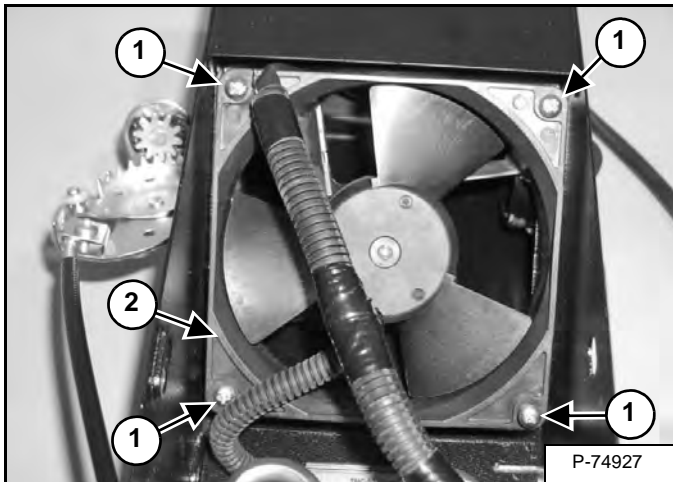

Remove the four screws (Item 1) then move the fan assembly (Item 2) [Figure 80-50-6] out of the way.

Figure 80-50-7

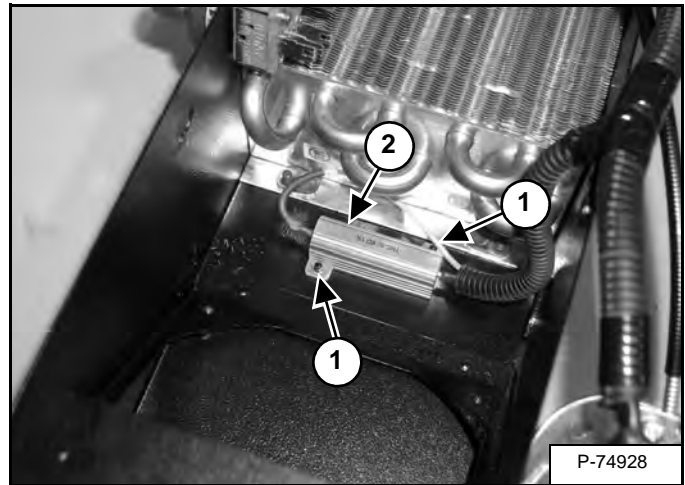

Remove the screws (Item 1) then move the resistor (Item 2) [Figure 80-50-7] out of the way.

Figure 80-50-8

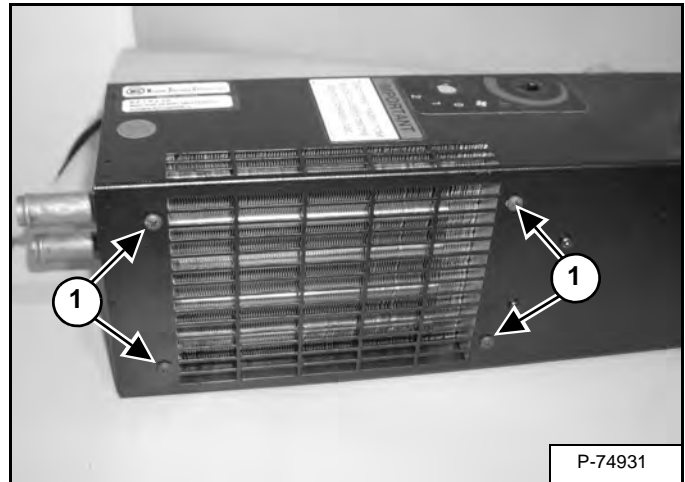

Remove the screws (Item 1) [Figure 80-50-8] located at the back of the heater assembly.

Figure 80-50-9

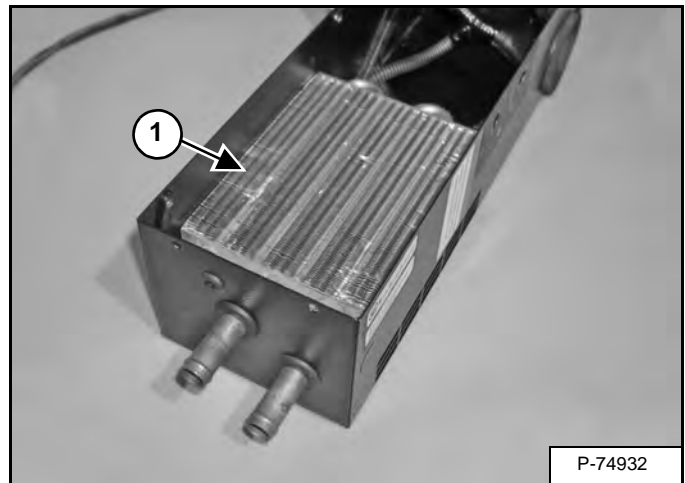

Remove the heater core (Item 1) [Figure 80-50-9] from the heater assembly.

**HEATER COIL (S/N A3W613400 & ABOVE,
A3W713236 & ABOVE, B38V11001 & ABOVE,
B38W11001 & ABOVE, B4TY11001 & ABOVE AND
B4UC11001 & ABOVE)**

Removal And Installation

Remove the heater unit from the loader. (See Removal And Installation on Page 80-41-1.)

Figure 80-51-1

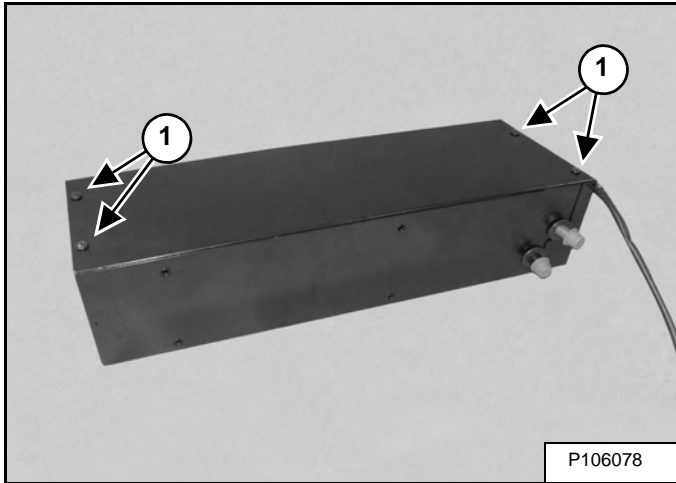

Remove the four screws (Item 1) [Figure 80-51-1] from the heater unit.

Figure 80-51-2

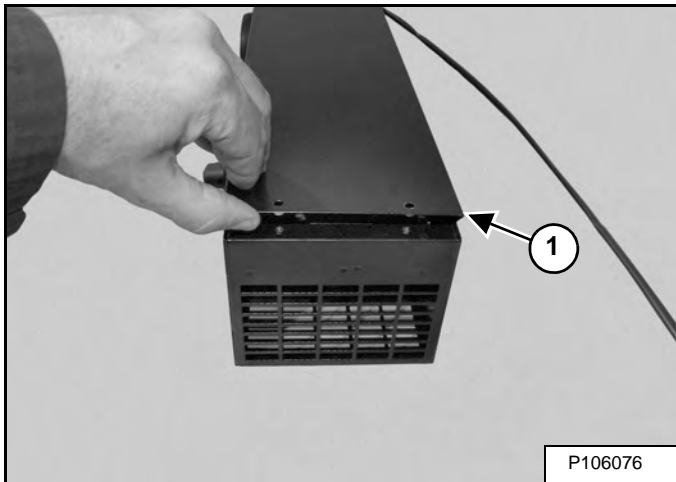

Remove the cover (Item 1) [Figure 80-51-2] from the heater unit.

Figure 80-51-3

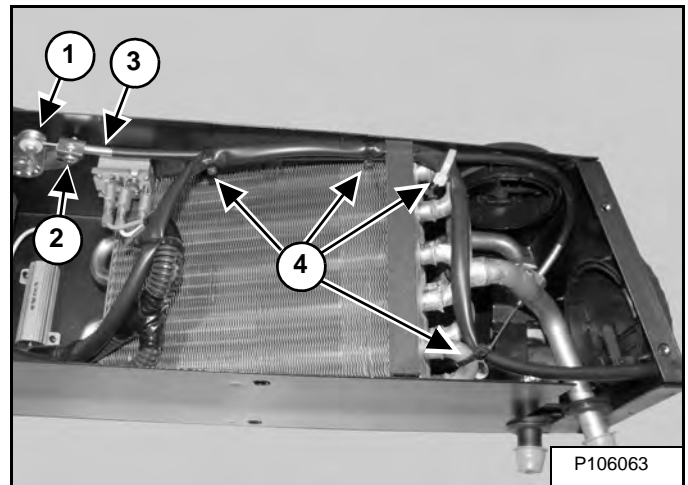

Remove the retainer washer (Item 1) (save for later use) loosen the screw (Item 2) and slide the cable (Item 3) [Figure 80-51-3].

Remove the tie straps (Item 4) [Figure 80-51-3].

HEATER COIL (S/N A3W613400 & ABOVE,
A3W713236 & ABOVE, B38V11001 & ABOVE,
B38W11001 & ABOVE, B4TY11001 & ABOVE AND
B4UC11001 & ABOVE) (CONT'D)

Removal And Installation (Cont'd)

Figure 80-51-4

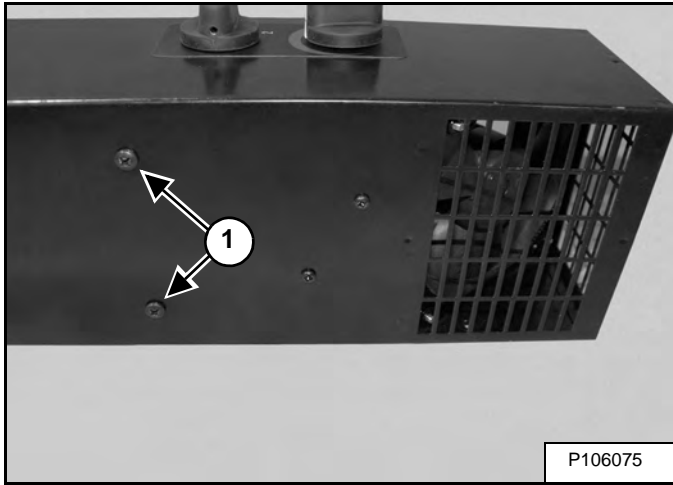
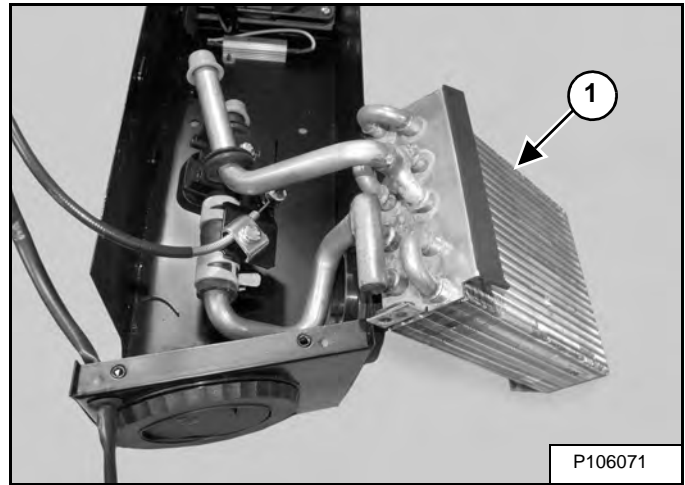
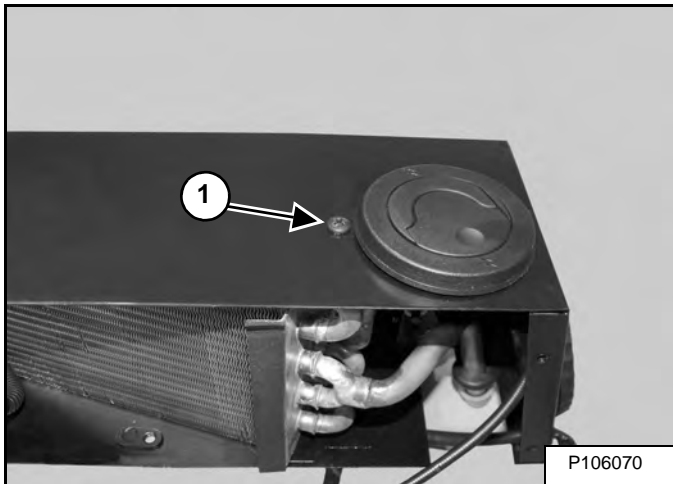

Figure 80-51-6



Remove the heater coil (Item 1) [Figure 80-51-6] from the heater unit.

Figure 80-51-5



Remove the screws (Item 1) [Figure 80-51-4] and [Figure 80-51-5].

HEATER FAN (S/N A3W611001 - A3W613399 AND A3W711001 - A3W713235)

Removal And Installation

Remove the heater assembly from the loader. (See Removal And Installation on Page 80-40-1.)

Figure 80-60-1

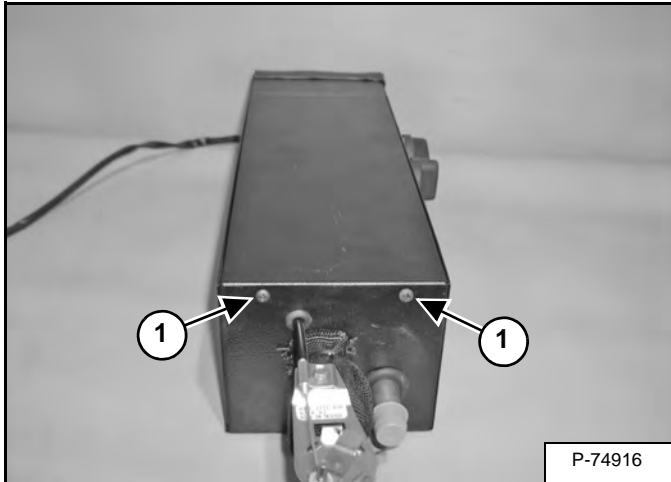

Remove the screws (Item 1) [Figure 80-60-1] from the bottom of the heater unit.

Figure 80-60-2

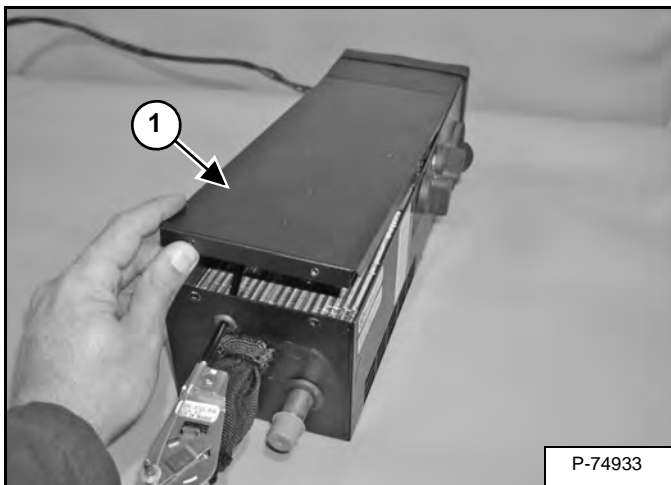

Remove the cover (Item 1) [Figure 80-60-2] from the heater unit.

Figure 80-60-3

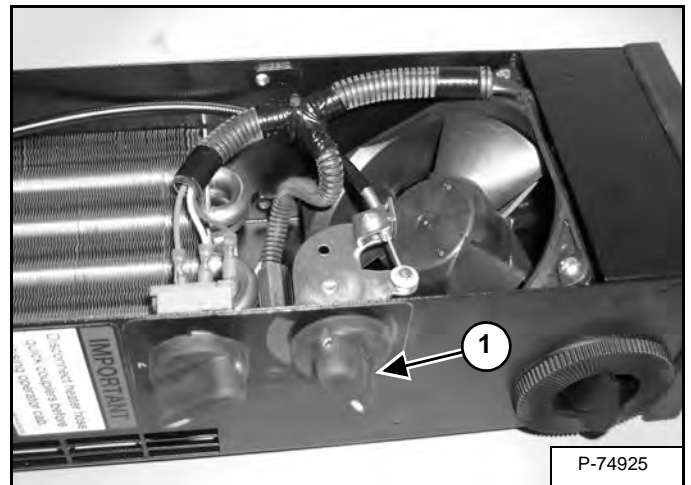

Remove the coolant flow adjustment knob (Item 1) [Figure 80-60-3].

Figure 80-60-4

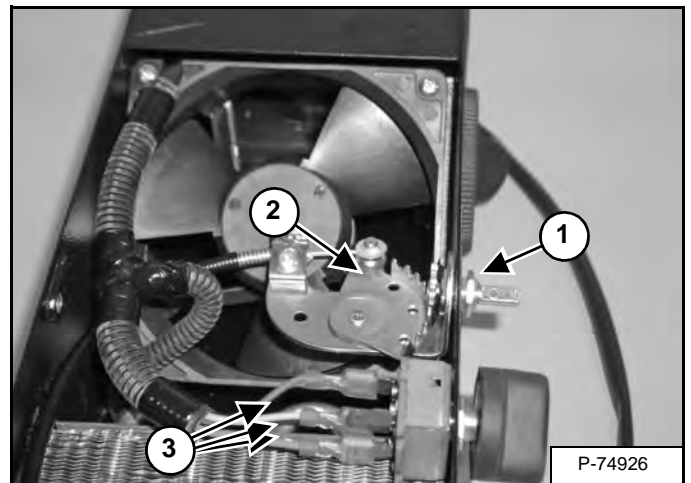

Remove the nut (Item 1) and move the coolant flow adjuster (Item 2) [Figure 80-60-4] out of the way.

Disconnect the wires (Item 3) [Figure 80-60-4] from the heater switch.

HEATER FAN (S/N A3W611001 - A3W613399 AND
A3W711001 - A3W713235) (CONT'D)

Removal And Installation (Cont'd)

Figure 80-60-5

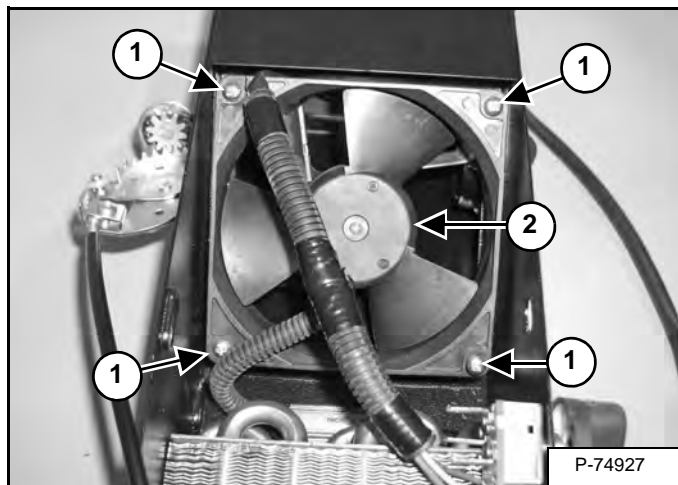

Remove the four screws (Item 1) then remove the heater fan (Item 2) [Figure 80-60-5] from the heater unit.

HEATER FAN (S/N A3W613400 & ABOVE, A3W713236 & ABOVE, B38V11001 & ABOVE, B38W11001 & ABOVE, B4TY11001 & ABOVE AND B4UC11001 & ABOVE)

Removal And Installation

Remove the heater assembly from the loader. (See Removal And Installation on Page 80-41-1.)

Figure 80-61-1

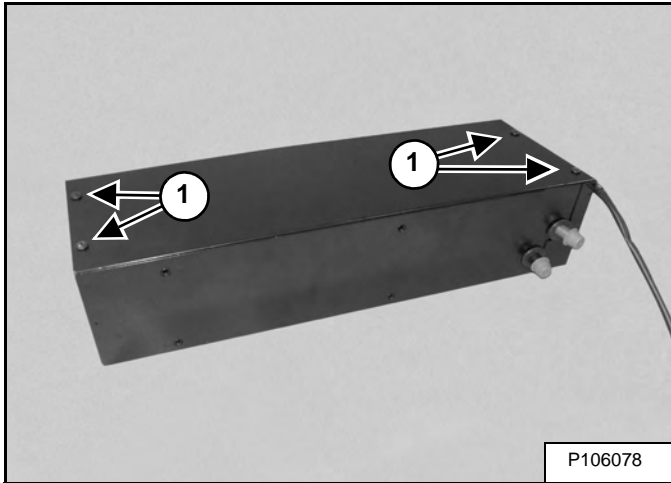

Remove the four screws (Item 1) [Figure 80-61-1] from the heater assembly.

Figure 80-61-2

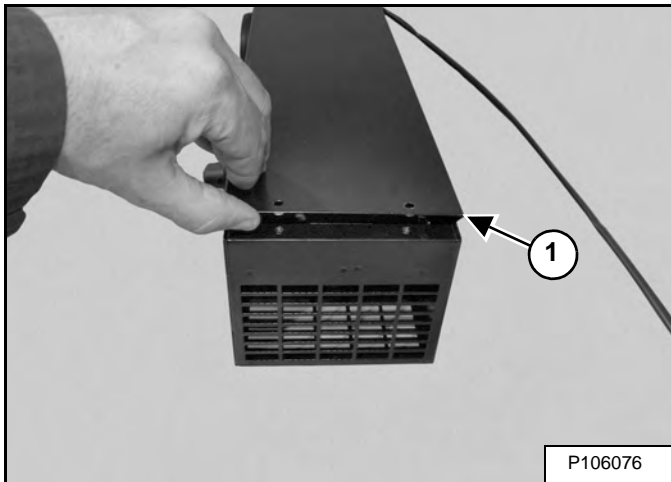

Remove the cover (Item 1) [Figure 80-61-2] from the heater assembly.

Figure 80-61-3

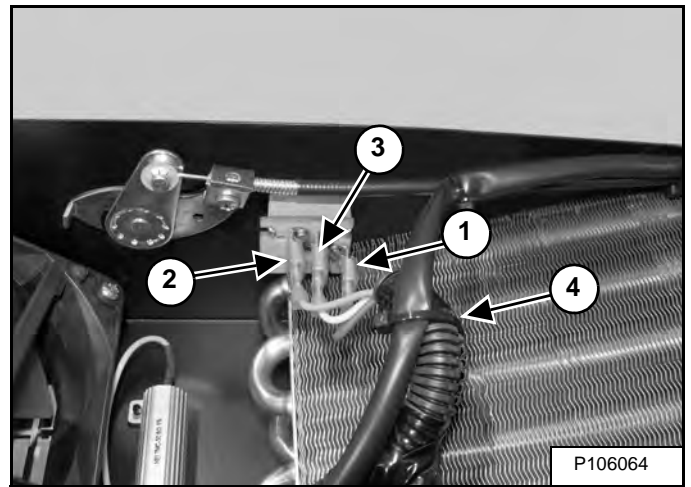

Remove the red wire (Item 1), orange wire (Item 2), and yellow wire (Item 3) [Figure 80-61-3] from the heater switch.

Remove the tie strap (Item 4) [Figure 80-61-3].

Figure 80-61-4

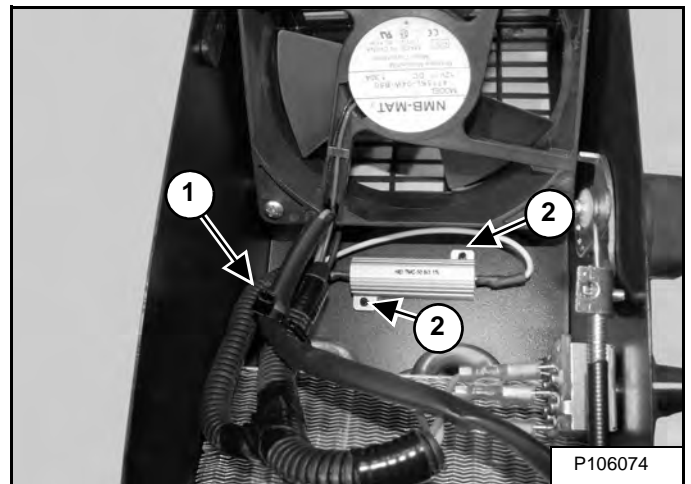

Remove the tie strap (Item 1). Remove the two screws (Item 2) [Figure 80-61-4] from the resistor. Save the screws for later use.

HEATER FAN (S/N A3W613400 & ABOVE, A3W713236 & ABOVE, B38V11001 & ABOVE, B38W11001 & ABOVE, B4TY11001 & ABOVE AND B4UC11001 & ABOVE) (CONT'D)

Removal And Installation (Cont'd)

Figure 80-61-5

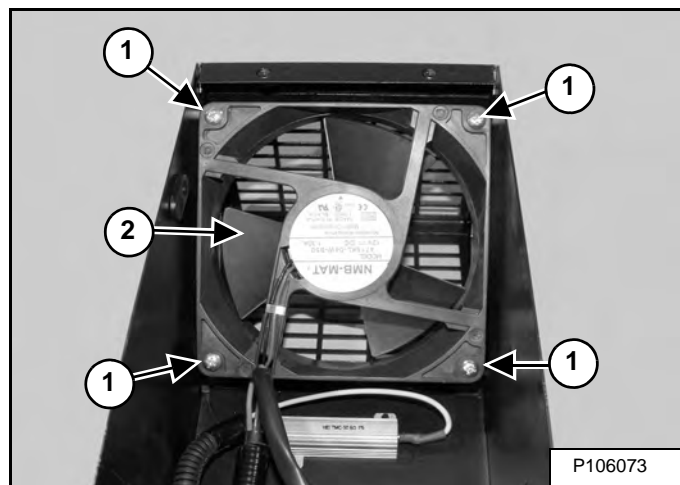

Remove the four screws (Item 1) and remove the fan (Item 2) [Figure 80-61-5] from the heater unit.

HEATER VALVE (S/N A3W611001 - A3W613399 AND A3W711001 - A3W713235)

Removal And Installation

Figure 80-70-1

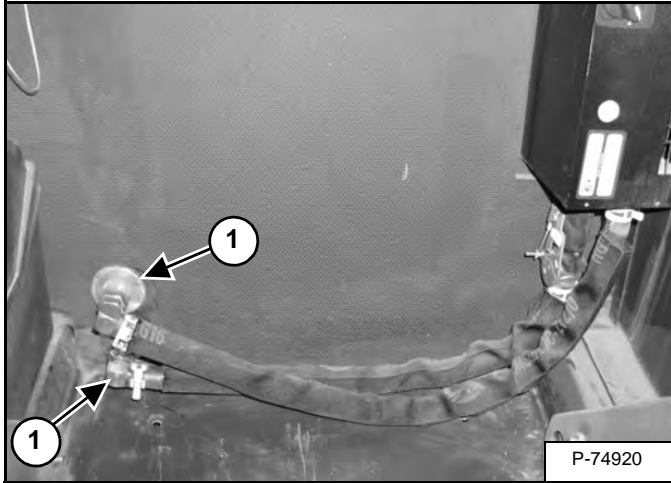

Disconnect the heater hose quick connectors (Item 1) [Figure 80-70-1] located at the back of the cab.

NOTE: The seat is removed for picture clarity only.

Figure 80-70-2

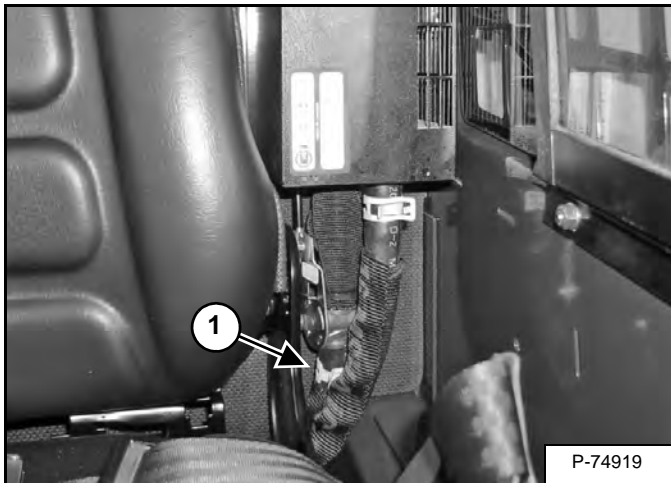

Loosen the clamp and remove the heater hose (Item 1) [Figure 80-70-2]. Install a plug in the hose.

NOTE: Some coolant will be lost during hose removal.

Figure 80-70-3

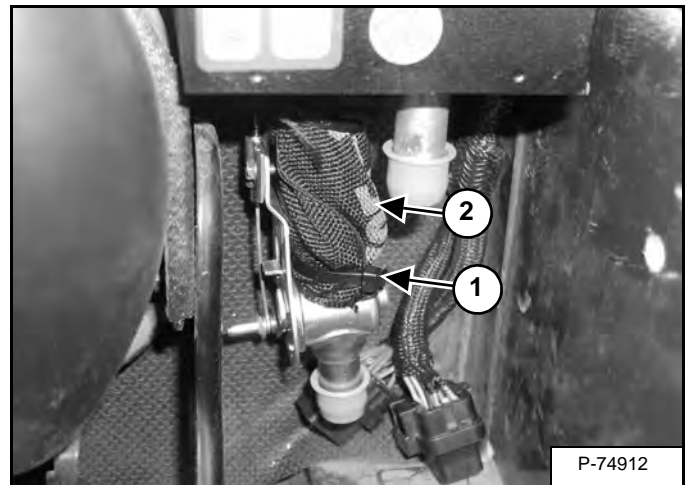

Remove the tie strap (Item 1) and lift the protective sleeve (Item 2) [Figure 80-70-3].

Figure 80-70-4

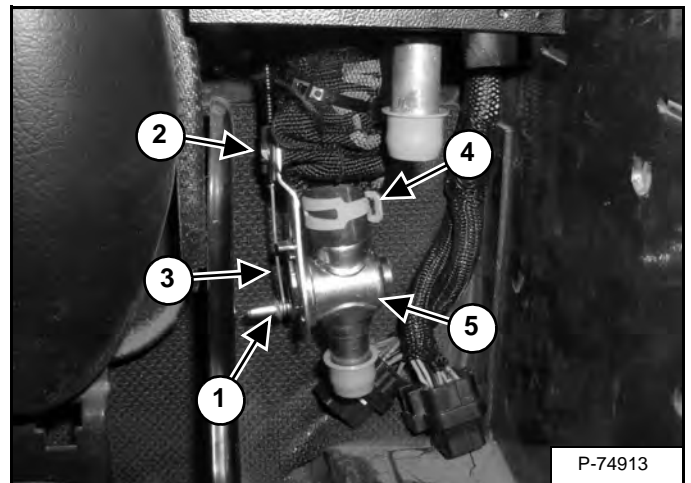

Remove the keeper washer (Item 1) and loosen the screw (Item 2) [Figure 80-70-4].

Slide the cable (Item 3) [Figure 80-70-4] off the post.

Loosen the clamp (Item 4) then remove the heater valve (Item 5) [Figure 80-70-4].



Bobcat®

**HEATER VALVE (S/N A3W613400 & ABOVE,
A3W713236 & ABOVE, B38V11001 & ABOVE,
B38W11001 & ABOVE, B4TY11001 & ABOVE AND
B4UC11001 & ABOVE)**

Removal And Installation

Remove the heater assembly from the loader. (See Removal And Installation on Page 80-41-1.)

Remove the heater coil from the heater unit. (See Removal And Installation on Page 80-51-1.)

Figure 80-71-1

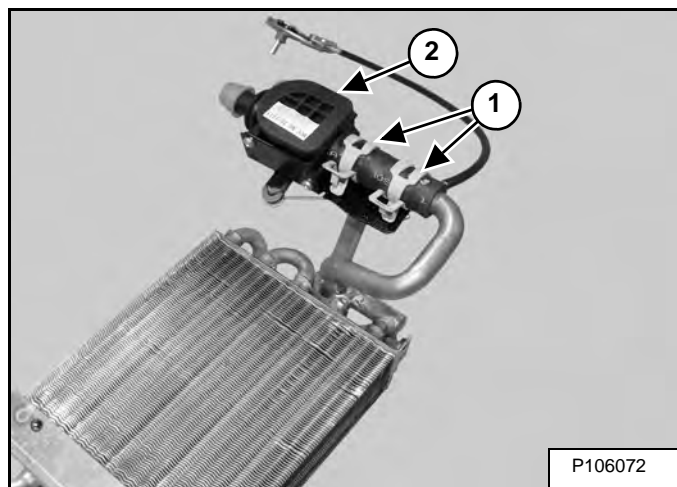

Loosen the hose clamps (Item 1) and remove the heater valve (Item 2) [**Figure 80-71-1**].



Bobcat®

HEATER SWITCH (S/N A3W611001 - A3W613399 AND A3W711001 - A3W713235)

Removal And Installation

Figure 80-80-1

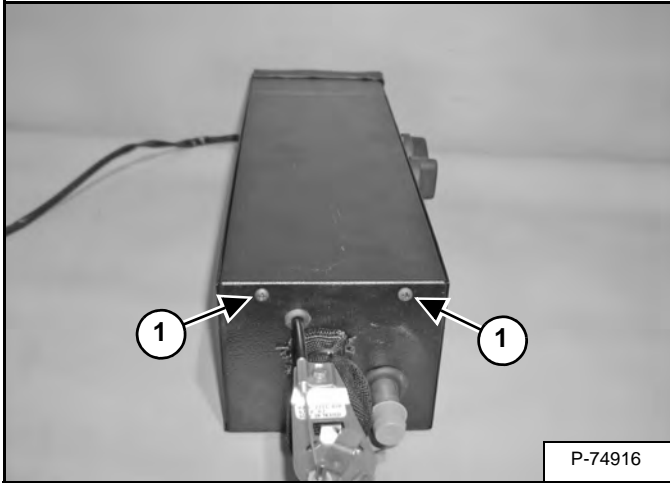

Remove the screws (Item 1) [Figure 80-80-1] from the bottom of the heater unit.

Figure 80-80-2

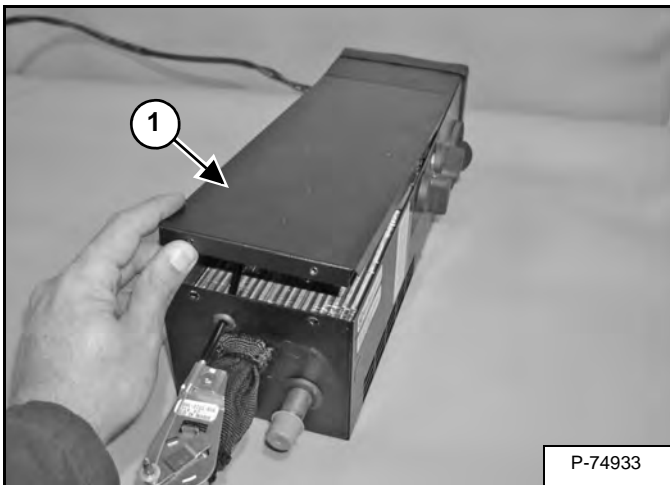

Remove the cover (Item 1) [Figure 80-80-2] from the heater unit.

Figure 80-80-3

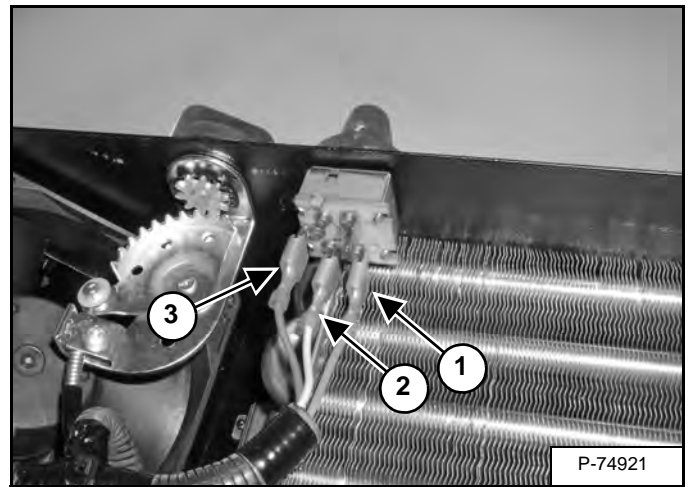

Remove the orange wire (Item 1), yellow wire (Item 2) and red wire (Item 3) [Figure 80-80-3] from the heater switch.

Figure 80-80-4

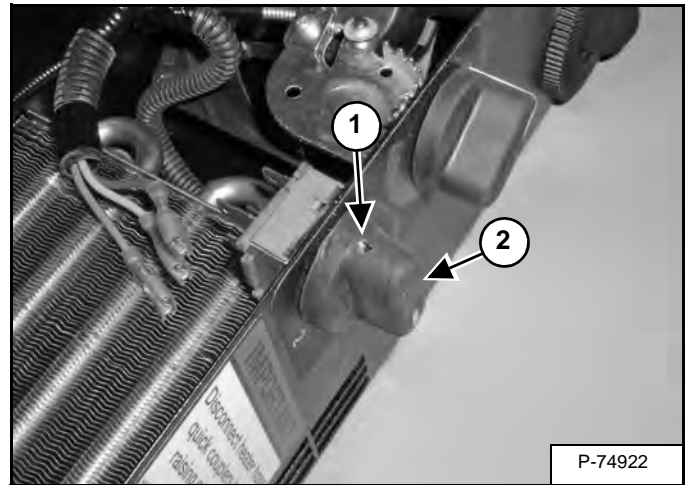

Loosen the set screw (Item 1) and remove the knob (Item 2) [Figure 80-80-4] from the heater switch.

HEATER SWITCH (S/N A3W611001 - A3W613399 AND A3W711001 - A3W713235) (CONT'D)

Removal And Installation (Cont'd)

Figure 80-80-5

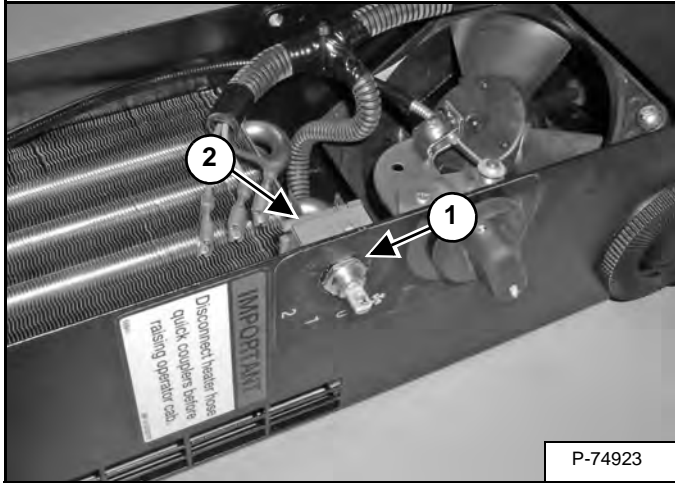

Remove the nut (Item 1) then remove the heater switch (Item 2) [Figure 80-80-5] from the heater unit.

Checking

Figure 80-80-6

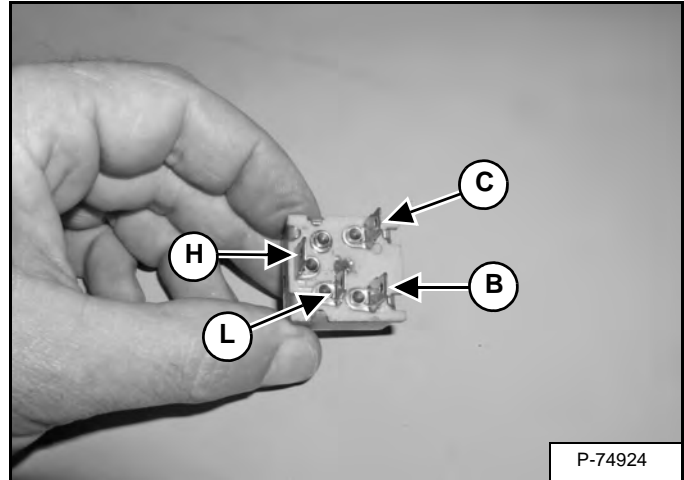

If there is voltage at the wiring harness, check the blower switch [Figure 80-80-6] for resistance.

With the switch in the **OFF** position, there should be resistance between L terminal and the H terminal frame.

With the switch in the **1** position, there should be resistance between **C** terminal and the **B** terminal, between the **C** terminal and the **L** terminal and also between the B terminal and the L terminal frame [Figure 80-80-6].

With the switch in the **2** position, there should be resistance between **C** terminal and the **B** terminal, between the **C** terminal and the **M** terminal and also between the B and the M terminal frame [Figure 80-80-6].

With the switch in the **3** position, there should be resistance between **C** terminal and the **B** terminal, between the **C** terminal and the **H** terminal and also between the B terminal and the H terminal frame [Figure 80-80-6].

If any of the above resistance tests fail, replace the blower switch.

**HEATER SWITCH (S/N A3W613400 & ABOVE,
A3W713236 & ABOVE, B38V11001 & ABOVE,
B38W11001 & ABOVE, B4TY11001 & ABOVE AND
B4UC11001 & ABOVE)**

Removal And Installation

Remove the heater assembly from the loader. (See Removal And Installation on Page 80-41-1.)

Figure 80-81-1

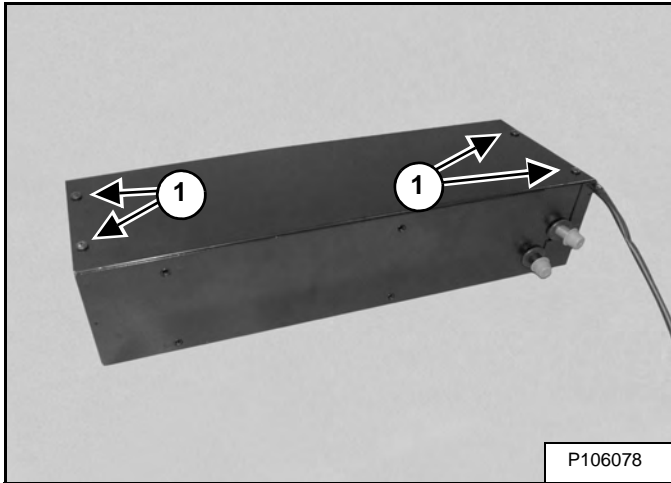

Remove the four screws (Item 1) [Figure 80-81-1] from the heater unit.

Figure 80-81-2

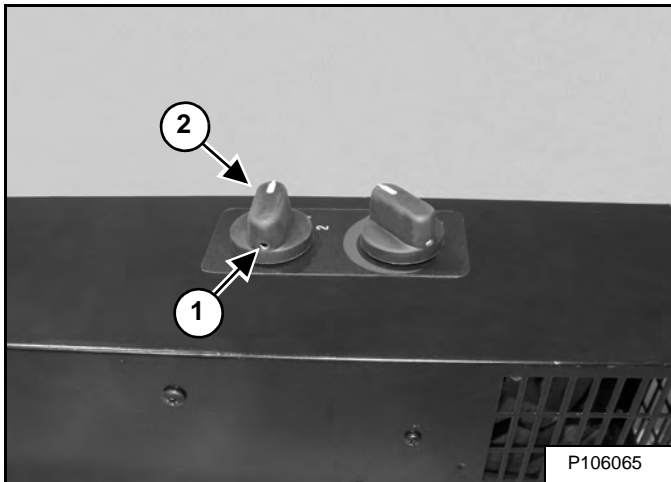

Loosen the set screw (Item 1) and remove the knob (Item 2) [Figure 80-81-2] from the heater switch.

Figure 80-81-3

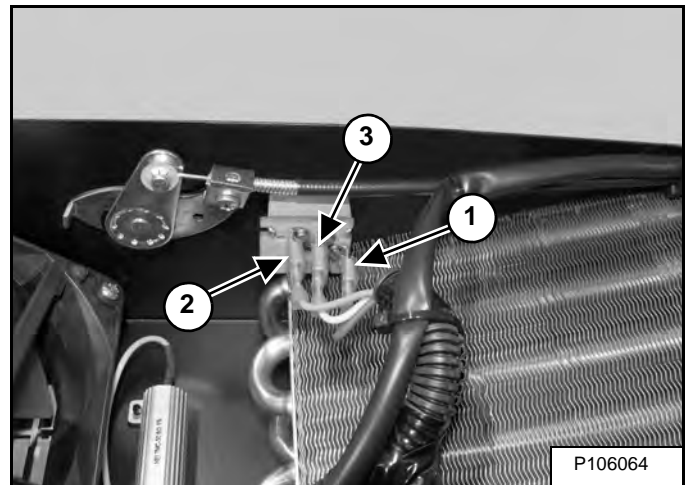

Remove the red wire (Item 1), orange wire (Item 2) and yellow wire (Item 3) [Figure 80-81-3] from the heater switch.

Figure 80-81-4

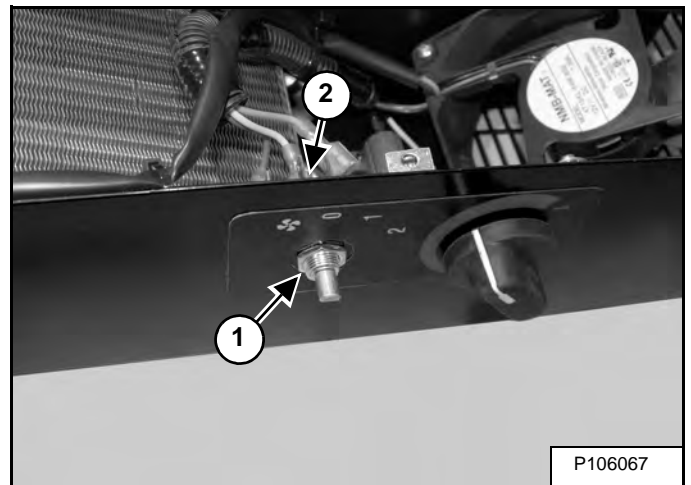

Remove the nut (Item 1) and remove the heater switch (Item 2) [Figure 80-81-4] from the heater assembly.

**HEATER SWITCH (S/N A3W613400 & ABOVE,
A3W713236 & ABOVE, B38V11001 & ABOVE,
B38W11001 & ABOVE, B4TY11001 & ABOVE AND
B4UC11001 & ABOVE) (CONT'D)**

Checking

Figure 80-81-5

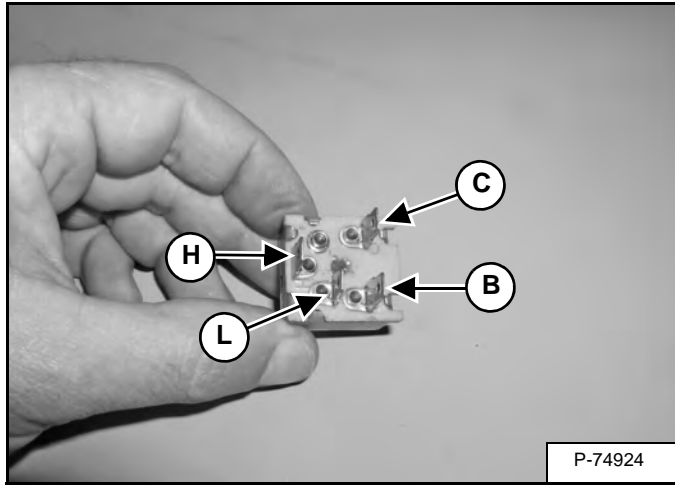

If there is voltage at the wiring harness, check the blower switch **[Figure 80-81-5]** for resistance.

With the switch in the **OFF** position, there should be resistance between L terminal and the H terminal frame.

With the switch in the **1** position, there should be resistance between **C** terminal and the **B** terminal, between the **C** terminal and the **L** terminal and also between the B terminal and the L terminal frame **[Figure 80-81-5]**.

With the switch in the **2** position, there should be resistance between **C** terminal and the **B** terminal, between the **C** terminal and the **M** terminal and also between the B and the M terminal frame **[Figure 80-81-5]**.

With the switch in the **3** position, there should be resistance between **C** terminal and the **B** terminal, between the **C** terminal and the **H** terminal and also between the B terminal and the H terminal frame **[Figure 80-81-5]**.

If any of the above resistance tests fail, replace the blower switch.

SPECIFICATIONS

(S70) LOADER SPECIFICATIONS	SPEC-10-1
Machine Dimensions	SPEC-10-1
Performance (A3W6, A3W7, B38V, B38W 11001 & Above)	SPEC-10-2
Performance (B4TY11001 & Above And B4UC11001 & Above)	SPEC-10-2
Engine	SPEC-10-2
Drive System	SPEC-10-4
Controls	SPEC-10-4
Hydraulic System	SPEC-10-5
Electrical	SPEC-10-5
Capacities	SPEC-10-6
Tires	SPEC-10-6
TECHNICAL SERVICE GUIDE SPECIFICATIONS	SPEC-20-1
Engine	SPEC-20-1
Engine Torques	SPEC-20-1
Cooling System	SPEC-20-1
Loader Torques	SPEC-20-2
Hydraulic / Hydrostatic System	SPEC-20-2
Fuel Consumption	SPEC-20-2
TORQUE SPECIFICATIONS FOR BOLTS	SPEC-30-1
Torque For General SAE Bolts	SPEC-30-1
Torque For General Metric Bolts	SPEC-30-2
HYDRAULIC CONNECTION SPECIFICATIONS	SPEC-40-1
O-ring Face Seal Connection	SPEC-40-1
Straight Thread O-ring Fitting	SPEC-40-2
Tubelines And Hoses	SPEC-40-2
Flare Fitting	SPEC-40-2
Port Seal Fitting	SPEC-40-3
HYDRAULIC / HYDROSTATIC FLUID SPECIFICATIONS	SPEC-50-1
Specifications	SPEC-50-1
CONVERSIONS	SPEC-60-1
Decimal And Millimeter Equivalent Chart	SPEC-60-1
U.S. To Metric Conversion Chart	SPEC-60-1

SERVICE TOOLS REQUIRED	SPEC-70-1
Remote Start Tools	SPEC-70-1
Hydraulic Tools	SPEC-70-2
Mainframe And Drive Tools	SPEC-70-5
Electrical Tools	SPEC-70-8
Engine Tools	SPEC-70-9
HVAC Tools	SPEC-70-14

Certain specification(s) are based on engineering calculations and are not actual measurements. Specification(s) are provided for comparison purposes only and are subject to change without notice. Specification(s) for your individual Bobcat equipment will vary based on normal variations in design, manufacturing, operating conditions, and other factors.

(S70) LOADER SPECIFICATIONS

Machine Dimensions

- Dimensions are given for loader equipped with standard tires and 36 inch dirt bucket and may vary with other bucket types.
- Where applicable, specifications conform to SAE or ISO standards and are subject to change without notice.

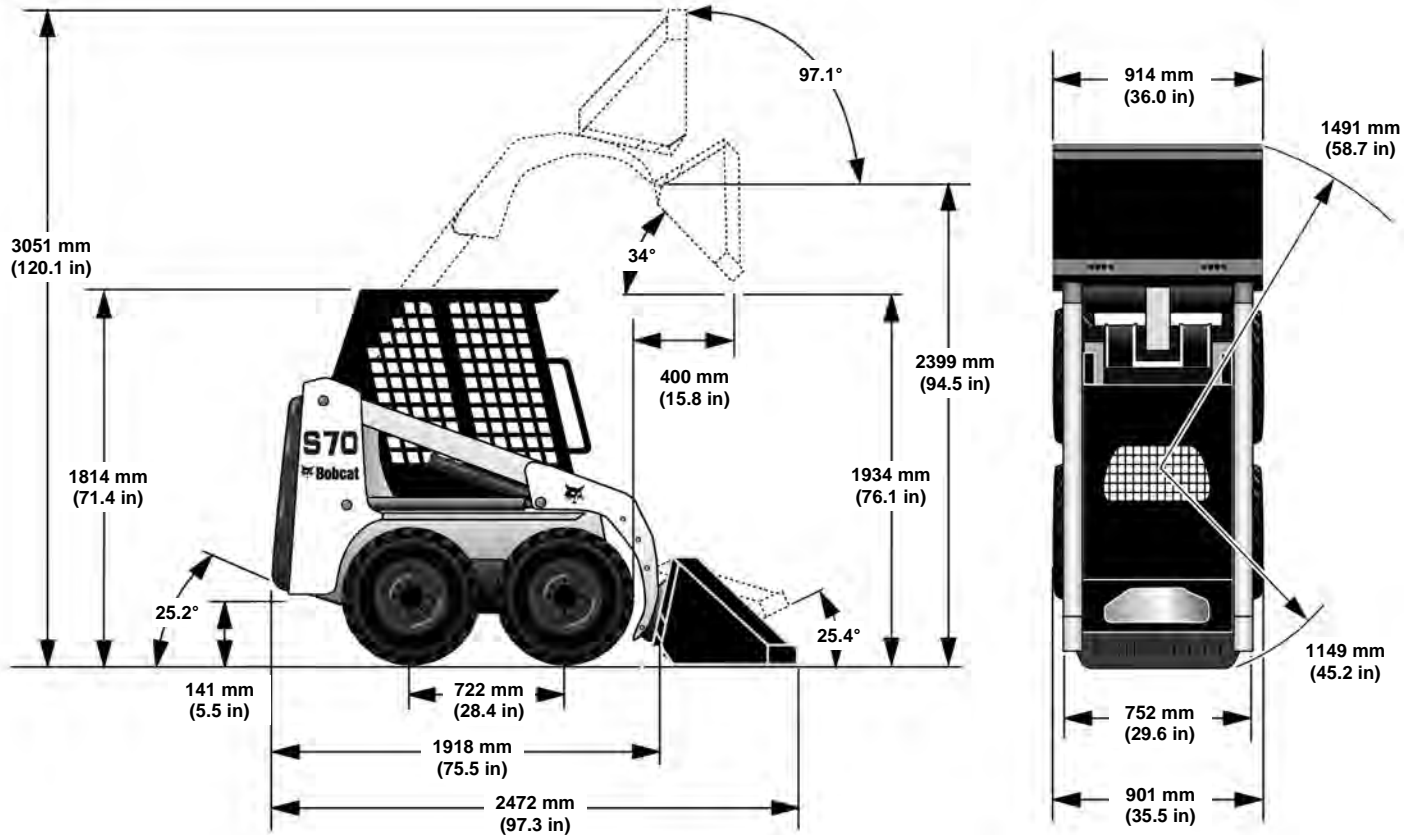

B-20824D

Changes of structure or weight distribution of the loader can cause changes in control and steering response and can cause failure of the loader parts.

(S70) LOADER SPECIFICATIONS (CONT'D)**Performance (A3W6, A3W7, B38V, B38W 11001 & Above)**

Rated Operating Capacity	318 kg (700 lb)
Tipping Load	636 kg (1512 lb)
Operating Weight	1268 kg (2795 lb)
SAE Breakout Force - Lift - Tilt	8607 N (1935 lb) 8674 N (1950 lb)
Travel Speed	0 - 9,8 km/h (0 - 6.1 mph)
Push Force	9519 N (2140 lb)

Performance (B4TY11001 & Above And B4UC11001 & Above)

Rated Operating Capacity	340 kg (750 lb)
Tipping Load	724 kg (1596 lb)
Operating Weight	1312 kg (2892 lb)
SAE Breakout Force - Lift - Tilt	8140 N (1830 lb) 9021 N (2028 lb)
Travel Speed	0 - 10,1 km/h (0 - 6.3 mph)
Push Force	9519 N (2140 lb)

Engine

Make / Model:	
– A3W611001 & Above	Kubota® / D1005-E3B-BC-3 Tier 4
– A3W711001 & Above	Kubota® / D1005-E3B-BC-3 Tier 4
– B38V11001 & Above	Kubota® / D1005-E4B-BC-3 Tier 4 NRTC
– B38W11001 & Above	Kubota® / D1005-E4B-BC-3 Tier 4 NRTC
– B38W11001 — B38W13370	Kubota® / D1005-E4B-BC-3 Stage III A
– B38W14001 & Above	Kubota® / D1005-E4B-BC-3 Stage V
– B4TY11001 & Above	Kubota® / D1005-E4B-BC-3 Stage V
– B4UC11001 & Above	Kubota® / D1005-E4B-BC-3 Tier 4
Fuel / Cooling	Diesel / Liquid
Horsepower:	
– ISO 9249 / SAE J1349 Net	16,8 kW (22.5 hp) @ 3000 rpm
– ISO 14396	17,2 kW (23.1 hp) @ 3000 rpm
– SAE J1995 Gross	17,5 kW (23.5 hp) @ 3000 rpm
Torque (SAE J1349 Gross)	62,8 N•m (46.3 ft-lb) @ 2200 rpm
Number of Cylinders	Three
Displacement	1001,0 cm ³ (61.08 in ³)
Bore / Stroke	76,0 mm / 73,6 mm (2.99 in / 2.90 in)
Lubrication	Gear Pump Pressure System with Filter
Crankcase Ventilation	Closed Breathing
Air Cleaner	Dry replaceable paper cartridge with separate safety element
Ignition	Diesel Compression
Air Induction	Naturally Aspirated
Low Idle	1125 - 1175 rpm
High Idle	3125 - 3175 rpm
Engine Coolant	Propylene Glycol / Water Mixture

(S70) LOADER SPECIFICATIONS (CONT'D)

Drive System

Main Drive	Hydrostatic 4 wheel drive
Transmission	Infinitely variable tandem hydrostatic piston pumps, driving two fully reversing hydrostatic motors.
Final Drive	Pre-stressed #60 HS endless roller chain (no master link) and sprockets in sealed chaincase with oil lubrication (Chains do not require periodic adjustments) Two chains per side with no idler sprocket
Total Engine to Wheel Reduction	31.25:1
Axle Size	37,6 mm (1.48 in), Heat treated
Wheel Bolts	Five - 9/16 inch wheel bolts fixed to axle hubs

Controls

Vehicle Steering	Direction and speed controlled by two hand operated steering levers.
Loader Hydraulics - Lift and Tilt - Front Auxiliary Hydraulics (Std.)	Controlled by separate foot pedals. Controlled by lateral movement of the right hand steering lever.
Engine	Hand lever speed control, key type start switch or optional keyless start and function error shutdown.
Starting Aid	Glow Plug - Manually activated using Key Switch or Keyless instrumentation.
Service Brake	Two independent hydrostatic systems controlled by two hand operated steering levers.
Secondary Brake	One of the hydrostatic transmissions.
Parking Brake (Standard)	Mechanical disc, manually operated switch on front instrument panel.

(S70) LOADER SPECIFICATIONS (CONT'D)

Hydraulic System

Pump Type	Engine driven gear type
Pump Capacity	33,7 L/min (8.9 U.S. gpm) @ 3150 engine rpm
Filters	Full flow replaceable, 10 micron synthetic media element
System Relief at Quick Couplers	20,7 MPa (207 bar) (3000 psi)
Hydraulic Cylinders	Double acting; Tilt cylinder has cushioning feature on dump and rollback
Bore Diameter: Lift Cylinder (2)	50,8 mm (2.00 in)
Tilt Cylinder (1)	76,2 mm (3.00 in)
Rod Diameter: Lift Cylinder (2)	31,8 mm (1.25 in)
Tilt Cylinder (1)	31,8 mm (1.25 in)
Stroke: Lift Cylinder (2)	555,5 mm (21.87 in)
Tilt Cylinder (1)	268,2 mm (10.56 in)
Control Valve	3-Spool, open center type with spring detent for lift float and detent auxiliary hydraulic spool
Fluid Lines	SAE standard tubelines, hoses and fittings.
Fluid Type	BOBCAT FLUID, Hydraulic / Hydrostatic 6903117 - (2.5 U.S. gal) 6903118 - (5 U.S. gal) 6903119 - (55 U.S. gal)
Hydraulic Function Time:	
Raise Lift Arms	3.5 Seconds
Lower Lift Arms	2.2 Seconds
Bucket Dump	2.1 Seconds
Bucket Rollback	1.8 Seconds

Electrical

Alternator	Belt driven, 65 amperes ventilated
Battery	12 volts, 650 cold cranking amperes @ -18°C (0°F) 115 minute reserve capacity at 25 amperes
Starter	12 volts, gear type, 1,4 kW (1.88 hp)
Instrumentation	Gauges: Hourmeter, Engine Coolant Temperature, Voltmeter, and Fuel Level (on tank). Warning lights: Engine Warning, Transmission Warning, and Seat Belt. Other: BICS™ Functions (on BICS™ Controller).

(S70) LOADER SPECIFICATIONS (CONT'D)

Capacities

Engine Cooling System	5,7 L (6.0 qt)
Fuel	24,6 L (6.5 U.S. gal)
Engine Lubrication with Filter	3,7 L (3.9 qt)
Hydraulic / Hydrostatic Reservoir	5 L (5.3 qt)
Hydraulic / Hydrostatic System	15,1 L (4.0 U.S. gal)
Chaincase Reservoir	11,4 L (3.0 U.S. gal)

Tires

Standard Duty (Standard)	23 x 5.70 - 12, 4 Ply Rating
Heavy Duty (Option)	23 x 8.50 - 12, 6 Ply Rating
Recommended Pressure	Inflate tires to MAXIMUM pressure shown on the side wall of the tire. DO NOT mix brands of tires used on the same loader.

TECHNICAL SERVICE GUIDE SPECIFICATIONS

Engine

Engine Oil Pressure at Low Idle	68 kPa (0,68 bar) (9.9 psi)
Engine Oil Pressure at High Idle	249 - 441 kPa (2,49 - 4,41 bar) (36.1 - 64 psi)
Firing Order	1-2-3
Location of Number 1 Cylinder	Closest to water pump
Crankshaft Rotation (Facing Crankshaft Pulley)	Clockwise
Valve Clearance (Cold) Intake	0,145 - 0,185 mm (0.0057 - 0.0073 in)
Valve Clearance (Cold) Exhaust	0,145 - 0,185 mm (0.0057 - 0.0073 in)

NOTE: For additional engine specifications, (See Specifications on Page 70-10-2.)

Engine Torques

Cylinder Head Bolt	64 - 68 N•m (47 - 50 ft-lb)
Main Bearing Bolts	49 - 53 N•m (36 - 39 ft-lb)
Connecting Rod Bolts	42 - 46 N•m (31 - 33 ft-lb)
Glow Plugs	8 - 14 N•m (6 - 10 ft-lb)
Flywheel Bolts	54 - 58 N•m (40 - 43 ft-lb)
Fuel Injection Tubeline Nuts	25 - 34 N•m (18 - 25 ft-lb)
Injector Nozzle	49 - 68 N•m (36 - 50 ft-lb)
Valve Cover Nuts	7 - 8 N•m (5 - 6 ft-lb)

NOTE: For additional engine torques, (See Torque Values on Page 70-10-6.)

Cooling System

Coolant Type and Mix	47% Water and 53% Propylene Glycol
Radiator Cap Pressure	88 kPa (0,9 bar) (12 psi)
Thermostat	Fully Open at 85°C (185°F)

NOTE: For additional cooling system information, (See ENGINE COOLING SYSTEM on Page 10-90-1.) and (See ENGINE COOLING SYSTEM on Page 70-50-1.)

TECHNICAL SERVICE GUIDE SPECIFICATIONS (CONT'D)

Loader Torques

Bob-Tach Pivot Pin Retainer Bolt	125 - 135 N•m (90 - 100 ft-lb)
Lift Arm Pivot Pin Retainer Bolt	24 - 27 N•m (18 - 20 ft-lb)
Tilt Cylinder Pivot Pin Retainer Bolt	24 - 27 N•m (18 - 20 ft-lb)
Control Valve Mounting Bolts	34 - 38 N•m (25- 28 ft-lb)
Hydraulic Pump Mounting Bolts	34 - 38 N•m (25- 28 ft-lb)
Hydrostatic Motor Mounting Nuts	122 - 135 N•m (90 - 100 ft-lb)
Hydrostatic Pump Pulley Bolt	47 - 54 N•m (35 - 40 ft-lb)
Main Frame Mounting Bolts	85 - 95 N•m (65 - 70 ft-lb)

NOTE: Additional loader torques can be found in the relevant section of this manual.

Hydraulic / Hydrostatic System

Pump Capacity at High Idle - Standard Flow	37,1 L/min (9.8 U.S. gpm)
Charge Pressure at High Idle Fluid Temp at 60°C (140°F) (minimum):	
S/N A3W611001 - A3W613788	517 - 586 kPa (5,1 - 5,9 bar) (75 - 85 psi)
S/N A3W711001 - A3W713562	517 - 586 kPa (5,1 - 5,9 bar) (75 - 85 psi)
S/N A3W613789 & Above	793 - 862 kPa (7,9 - 8,6 bar) (115 - 125 psi)
S/N A3W713563 & Above	793 - 862 kPa (7,9 - 8,6 bar) (115 - 125 psi)
S/N B38V11001 & Above	793 - 862 kPa (7,9 - 8,6 bar) (115 - 125 psi)
S/N B38W11001 & Above	793 - 862 kPa (7,9 - 8,6 bar) (115 - 125 psi)
Check Charge Pressure	See Loader Service Manual
Maximum Cylinder Drift Allowed Without Bucket in 10 Minutes	33 mm (1.3 in)

NOTE: For additional hydraulic / hydrostatic system information, (See **HYDRAULIC SYSTEM INFORMATION** on Page 20-10-1.) and (See **HYDROSTATIC SYSTEM INFORMATION** on Page 30-10-1.)

Fuel Consumption

Engine Load	Full - 100%	High - 70%	Medium - 50%	Low - 30%
Fuel Consumption Rate Per Hour	5,56 L (1.47 U.S. gal)	3,71 L (0.98 U.S. gal)	3,03 L (0.8 U.S. gal)	2,65 L (0.7 U.S. gal)

NOTE: The engine fuel consumption chart is to be used as a guideline only. The actual results may vary.

High - Continuous loading or digging or load / carrying cycles; little idling.

Medium - Average loading or load / carrying cycles; some idling.

Low - Light loading or carrying - not much digging or pushing; considerable idling.

TORQUE SPECIFICATIONS FOR BOLTS

Torque For General SAE Bolts

The following table shows standard torque specifications for bolts with zinc phosphate coating. Bolts purchased from Bobcat Company that have zinc phosphate coating are specified by the letter H following the part number.

	Thread size	SAE grade 5	SAE grade 8
N•m (in-lb)	0.250	9,0 - 10,2 (80 - 90)	12,4 - 13,6 (110 - 120)
	0.3125	20,3 - 22,6 (180 - 200)	24,2 - 27,1 (215 - 240)
N•m (ft-lb)	0.375	34 - 38 (25 - 28)	47 - 54 (35 - 40)
	0.4375	54 - 61 (40 - 45)	81 - 88 (60 - 65)
	0.500	88 - 95 (65 - 70)	122 - 136 (90 - 100)
	0.5625	122 - 136 (90 - 100)	170 - 190 (125 - 140)
	0.625	170 - 190 (125 - 140)	240 - 260 (175 - 190)
	0.750	300 - 330 (220 - 245)	410 - 450 (300 - 330)
	0.875	450 - 490 (330 - 360)	645 - 710 (475 - 525)
	1.000	645 - 710 (475 - 525)	985 - 1085 (725 - 800)
	1.125	880 - 975 (650 - 720)	1425 - 1600 (1050 - 1175)
	1.250	1200 - 1360 (900 - 1000)	2000 - 2200 (1475 - 1625)
	1.375	1630 - 1830 (1200 - 1350)	2720 - 2980 (2000 - 2200)
	1.500	2040 - 2240 (1500 - 1650)	3530 - 3870 (2600 - 2850)
	1.625	2720 - 2980 (2000 - 2800)	4680 - 5150 (3450 - 3800)
	1.750	3390 - 3730 (2500 - 2750)	5830 - 6500 (4300 - 4800)
1.875	4270 - 4750 (3150 - 3500)	7450 - 8300 (5500 - 6100)	
2.000	5150 - 5700 (3800 - 4200)	8800 - 9800 (6500 - 7200)	

TORQUE SPECIFICATIONS FOR BOLTS (CONT'D)**Torque For General Metric Bolts**

THREAD SIZE (DIA. X PITCH)	MATERIAL		
	HEAD MARK 4	HEAD MARK 7	HEAD MARK 10
M 5 x 0.8		4 - 5 N•m (3 - 4 ft-lb)	
M 6 x 1.0		8 - 9 N•m (6 - 7 ft-lb)	8 - 12 N•m (6 - 9 ft-lb)
M 8 x 1.25	8 - 12 N•m (6 - 9 ft-lb)	15 - 22 N•m (11 - 16 ft-lb)	24 - 34 N•m (18 - 25 ft-lb)
M 10 x 1.25	18 - 24 N•m (13 - 18 ft-lb)	30 - 41 N•m (22 - 30 ft-lb)	49 - 68 N•m (36 - 50 ft-lb)
M 12 x 1.25	30 - 41 N•m (22 - 30 ft-lb)	54 - 73 N•m (40 - 54 ft-lb)	94 - 118 N•m (69 - 87 ft-lb)
M 14 x 1.25	49 - 68 N•m (36 - 50 ft-lb)	79 - 108 N•m (58 - 80 ft-lb)	157 - 186 N•m (116 - 137 ft-lb)

HYDRAULIC CONNECTION SPECIFICATIONS

O-ring Face Seal Connection

IMPORTANT

When repairing hydrostatic and hydraulic systems, clean the work area before disassembly and keep all parts clean. Always use caps and plugs on hoses, tubelines and ports to keep dirt out. Dirt can quickly damage the system.

I-2003-0888

Figure SPEC-40-1

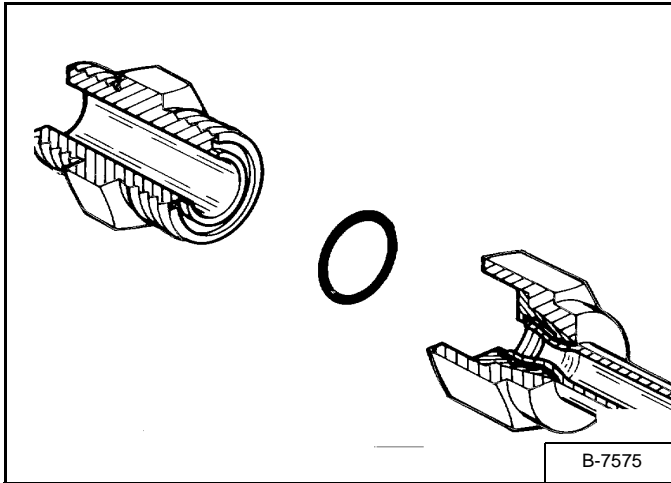

When the fitting is tightened, you can feel when the fitting is tight to eliminate leakage caused by under or over torqued fittings. Use vaseline petroleum jelly to hold the O-ring in position until the fittings are assembled [Figure SPEC-40-1].

Figure SPEC-40-2

O-ring Face Seal Tightening Torque		
Tubeline Outside Diameter	Thread Size	TORQUE N•m (ft-lb)
1/4"	9/16" - 18	18 (13)
3/8"	11/16" - 16	30 (22)
1/2"	13/16" - 16	54 (40)
5/8"	1" - 14	81 (60)
3/4"	1-3/16" - 12	114 (84)
7/8"	1-3/16" - 12	133 (98)
1"	1-7/16" - 12	160 (118)
1-1/4"	1-11/16" - 12	209 (154)
1-1/2"	2" - 12	221 (163)

HYDRAULIC CONNECTION SPECIFICATIONS (CONT'D)

Straight Thread O-ring Fitting

Figure SPEC-40-3

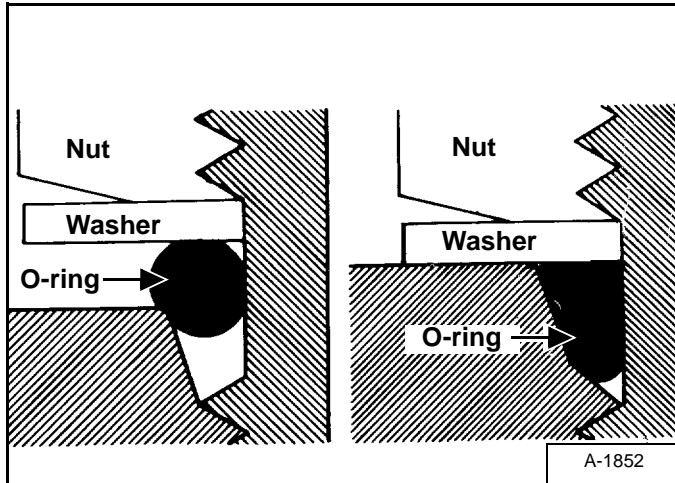

Lubricate the O-ring before installing the fitting. Loosen the locknut and install the fitting. Tighten the locknut until the washer is tight against the surface [Figure SPEC-40-3].

Tubelines And Hoses

Replace any tubelines that are bent or flattened. They will restrict flow, which will slow hydraulic action and cause heat.

Replace hoses which show signs of wear, damage or weather cracked rubber.

Always use two wrenches when loosening and tightening hose or tubeline fittings.

Flare Fitting

Figure SPEC-40-4

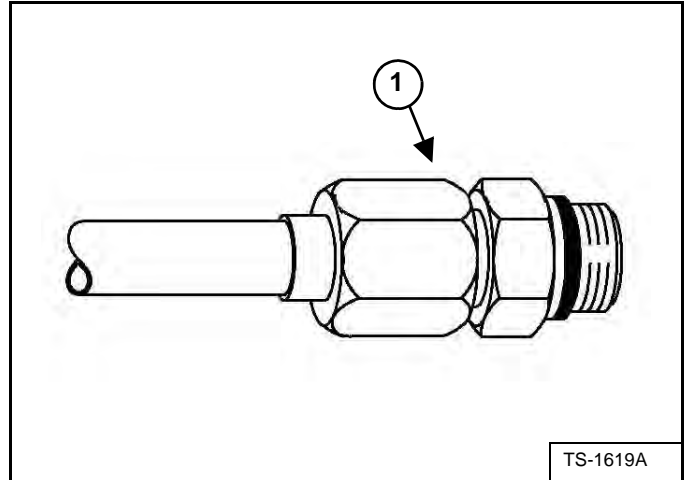

Use the following procedure to tighten the flare fitting:

Tighten the nut until it makes contact with the seat. Make a mark across the flats of both the male and female parts of the connection (Item 1) [Figure SPEC-40-4].

Use the chart [Figure SPEC-40-5] to find the correct tightness needed. If the fitting leaks after tightening, disconnect it and inspect the seat area for damage.

Figure SPEC-40-5

Flare Fitting Tightening Torque		
Tubeline Outside Diameter	Thread Size	TORQUE N•m (ft-lb)
1/4"	7/16" - 20	18 (13)
5/16"	1/2" - 20	23 (17)
3/8"	9/16" - 18	30 (22)
1/2"	3/4" - 16	54 (40)
5/8"	7/8" - 14	81 (60)
3/4"	1-1/16" - 12	114 (84)
7/8"	1-3/16" - 12	133 (98)
1"	1-5/16" - 12	160 (118)
1-1/4"	1-5/8" - 12	209 (154)
1-1/2"	1-7/8" - 12	221 (163)
2"	2-1/2" - 12	342 (252)

**HYDRAULIC CONNECTION SPECIFICATIONS
(CONT'D)**

Port Seal Fitting

Figure SPEC-40-6

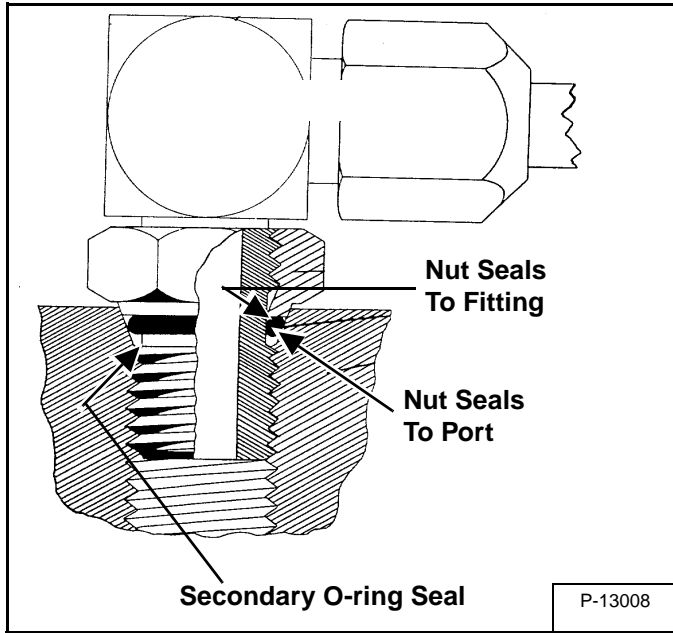

The nut is the primary seal, the O-ring is the secondary seal and helps absorb vibration and pressure pulses at the connection [Figure SPEC-40-6].

The hex portion of the nut does not contact the surface of the component when the nut is tight.

Figure SPEC-40-7

Port Seal and O-ring Boss Tightening Torque	
Thread Size	TORQUE N•m (ft-lb)
7/16" - 20	18 (13)
9/16" - 18	22 (30)
3/4" - 16	40 (54)
7/8" - 14	60 (81)
1-1/16" - 12	84 (114)
1-3/16" - 12	98 (133)
1-5/16" - 12	118 (160)
1-7/16" - 12	154 (209)
1-5/8" - 12	163 (221)

Use the following procedure to tighten the port seal fitting:

Port seal and nut, washer and O-ring (O-ring Boss) fittings use the same tightening torque valve chart.



Bobcat®

HYDRAULIC / HYDROSTATIC FLUID SPECIFICATIONS

Specifications

HYDRAULIC / HYDROSTATIC FLUID RECOMMENDED ISO VISCOSITY GRADE (VG) AND VISCOSITY INDEX (VI)

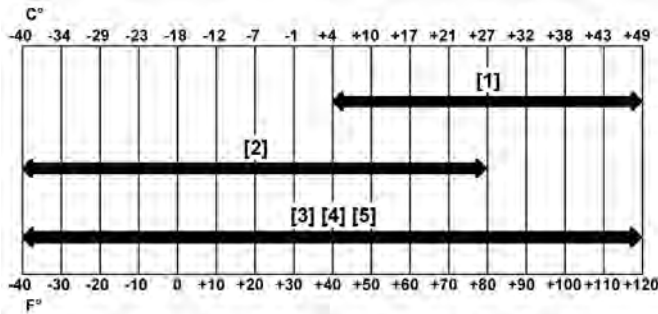

TEMPERATURE RANGE ANTICIPATED DURING MACHINE USE

- [1] VG 100; Minimum VI 130
- [2] VG 46; Minimum VI 150
- [3] BOBCAT All-Season Fluid
- [4] BOBCAT Synthetic Fluid
- [5] BOBCAT Biodegradable Hydraulic / Hydrostatic Fluid (Unlike biodegradable fluids that are vegetable based, Bobcat biodegradable fluid is formulated to prevent oxidation and thermal breakdown at operating temperatures.)

DO NOT use automatic transmission fluids in the loader or permanent damage to the transmission will result.

! WARNING

AVOID INJURY OR DEATH

Diesel fuel or hydraulic fluid under pressure can penetrate skin or eyes, causing serious injury or death. Fluid leaks under pressure may not be visible. Use a piece of cardboard or wood to find leaks. Do not use your bare hand. Wear safety goggles. If fluid enters skin or eyes, get immediate medical attention from a physician familiar with this injury.

W-2072-0807

When temperatures below -18°C (0°F) are common, the loader must be kept in a warm building. Extra warm-up time must be used each time the loader is started during cold temperature conditions. Cold fluid will not flow easily and it makes action of the hydraulic function slower. Loss of fluid flow to the hydrostatic transmission pump (indicated by TRANS light ON) can cause transmission damage in less than 60 seconds.

! WARNING

During cold weather (0°C [32°F] and below), do not operate machine until the engine has run for at least 5 minutes at less than half throttle. This warm-up period is necessary for foot pedal operation and safe stopping. Do not operate controls during warm-up period.

When temperatures are below -30°C (-20°F), the hydrostatic oil must be heated or kept warm. The hydrostatic system will not get enough oil at low temperatures. Park the machine in an area where the temperature will be above -18°C (0°F) if possible.

W-2027-0311



Bobcat®

CONVERSIONS

Decimal And Millimeter Equivalent Chart

FRACTIONS	DECIMALS	MM	FRACTIONS	DECIMALS	MM	
	1/64 —	0.015625 —	0.397	33/64 —	0.515625 —	13.097
1/32 —	0.03125 —	0.794	17/32 —	0.53125 —	13.494	
	3/64 —	0.046875 —	1.191	35/64 —	0.546875 —	13.891
1/16 —	0.0625 —	1.588	9/16 —	0.5625 —	14.288	
	5/64 —	0.078125 —	1.984	37/64 —	0.578125 —	14.684
3/32 —	0.09375 —	2.381	19/32 —	0.59375 —	15.081	
	7/64 —	0.109375 —	2.778	39/64 —	0.609375 —	15.478
1/8 —	0.1250 —	3.175	5/8 —	0.6250 —	15.875	
	9/64 —	0.140625 —	3.572	41/64 —	0.640625 —	16.272
5/32 —	0.15625 —	3.969	21/32 —	0.65625 —	16.669	
	11/64 —	0.171875 —	4.366	43/64 —	0.671875 —	17.066
3/16 —	0.1876 —	4.762	11/16 —	0.6875 —	17.462	
	13/64 —	0.203125 —	5.159	45/64 —	0.703125 —	17.859
7/32 —	0.21875 —	5.556	23/32 —	0.71875 —	18.256	
	15/64 —	0.234375 —	5.953	47/64 —	0.734375 —	18.653
1/4 —	0.2500 —	6.350	3/4 —	0.7500 —	19.050	
	17/64 —	0.265625 —	6.747	49/64 —	0.765625 —	19.447
9/32 —	0.28125 —	7.144	25/32 —	0.78125 —	19.844	
	19/64 —	0.296875 —	7.541	51/64 —	0.796875 —	20.241
5/16 —	0.3125 —	7.938	13/16 —	0.8125 —	20.638	
	21/64 —	0.328125 —	8.334	53/64 —	0.828125 —	21.034
11/32 —	0.34375 —	8.731	27/32 —	0.84375 —	21.431	
	23/64 —	0.359375 —	9.128	55/64 —	0.859375 —	21.828
3/8 —	0.3750 —	9.525	7/8 —	0.8750 —	22.225	
	25/64 —	0.390625 —	9.922	57/64 —	0.890625 —	22.622
13/32 —	0.40625 —	10.319	29/32 —	0.90625 —	23.019	
	27/64 —	0.421875 —	10.716	59/64 —	0.921875 —	23.416
7/16 —	0.4375 —	11.112	15/16 —	0.9375 —	23.812	
	29/64 —	0.453125 —	11.509	61/64 —	0.953125 —	24.209
15/32 —	0.46875 —	11.906	31/32 —	0.96875 —	24.606	
	31/64 —	0.484375 —	12.303	63/64 —	0.984375 —	25.003
1/2 —	0.5000 —	12.700	1 —	1.000 —	25.400	

1 mm = 0.03937"

0.001 = 0.0254 mm

U.S. To Metric Conversion Chart

	TO CONVERT	INTO	MULTIPLY BY
LINEAR MEASUREMENT	Miles	Kilometers	1.609
	Yards	Meters	0.9144
	Feet	Meters	0.3048
	Feet	Centimeters	30.48
	Inches	Meters	0.0254
	Inches	Centimeters	2.54
	Inches	Millimeters	25.4
AREA	Square Miles	Square Kilometers	2.59
	Square Feet	Square Meters	0.0929
	Square Inches	Square Centimeters	6.452
	Acre	Hectare	0.4047
VOLUME	Cubic Yards	Cubic Meters	0.7646
	Cubic Feet	Cubic Meters	0.02832
	Cubic Inches	Cubic Centimeters	16.39
WEIGHT	Tons (Short)	Metric Tons	0.9078
	Pounds	Kilograms	0.4536
	Ounces (Avdp.)	Grams	28.3495
PRESSURE	Pounds/Sq. In.	Kilopascal	6.895
WORK	Foot-Pounds	Newton-Meter	1.356
LIQUID VOLUME	Quarts	Liters	0.9463
	Gallons	Liters	3.785
LIQUID FLOW	Gallons/Minute	Liters/Minute	3.785
TEMPERATURE	Fahrenheit	Celsius	1. Subtract 32°
			2. Multiply by 5/9











Bobcat®

SERVICE TOOLS REQUIRED

The following is a list of service tools required for servicing loaders.

Remote Start Tools





TOOL PART NUMBER	DESCRIPTION	MODELS USED ON	COMMENT	IMAGE
MEL1563	Remote Start Tool	S70,S100,T110 S450 - S850 T450 - T870 A770	This tool has been replaced by the new remote start tool 7217666, see below. MEL1563 includes: MEL1565 and MEL1566.	
MEL1565	Service Tool Harness		Used with MEL1563 to connect remote start tool to machine.	
MEL1566	Service Tool Harness Communicator		Used with MEL1563 to connect remote start tool to Service PC.	
7217666 (Was 7003031) (Was 6689779)	Remote Start Tool KIT		This tool replaced the original remote start tool kit MEL1563, 7003031 and 6689779. Kit 7217666 includes: 7022042, 6689747, 6689746 and 6689745.	
7022042 (Was 7003030) (Was 6689778)	Remote Start Tool		This tool replaces remote start tool 6689778 and 7003030.	
6689747	Remote Start Tool Harness		Used with 7022042 to connect remote start tool to machine.	
6689746	Remote Start Tool Harness		Used with 7022042 to connect Service PC to remote start tool.	
6689745	BOSS Service Tool Harness		Included with 7217666 but only used on early model loaders equipped with BOSS.	
7152935	Service Tool Harness	Loaders with the 7 pin attachment harness.	Used to connect the 7 pin attachment harness to remote start tool.	

See BobcatDealerNET.com for parts ordering information. (For EMEA dealers see the Bobcat Special Tools Catalogue and Doosan Shop for parts ordering information.)

ST LDR-0219

SERVICE TOOLS REQUIRED (CONT'D)

Hydraulic Tools

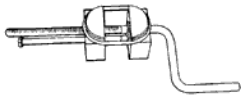
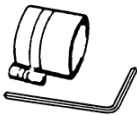
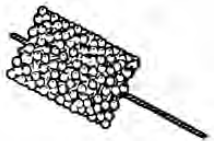





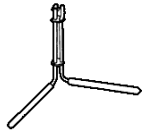
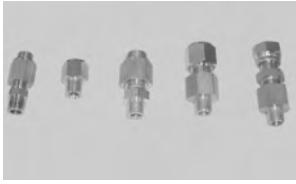

TOOL PART NUMBER	DESCRIPTION	MODELS USED ON	COMMENT	IMAGE
MEL1744	Hydraulic Tester (Flow Meter)	S70, S100, T110 S450 - S850 T450 - T870 A770	Hydraulic tester MEL1744, MEL10003 or TWX-RFIK200-S-6 can be used for hydraulic testing.	
MEL10003	Hydraulic Tester (Flow Meter)		MEL10003 and TWX-RFIK200-S-6 are no longer available, order MEL1744.	
TWX-RFIK200-S-6	Hydraulic Tester (Flow Meter)			
MEL1074	O-Ring Seal Hook			
MEL1075	Adjustable Gland Nut Wrench		Includes MEL1075-1 and MEL1075-2	
MEL1075-1	Standard Pins		These are replaceable pins that insert into MEL1075 for disassembling various cylinders.	No Image Available
MEL1075-2	Offset Pins		These are replaceable pins that insert into MEL1075 for disassembling various cylinders.	No Image Available
MEL1396-1	Universal Seal Expander		MEL1396 includes: MEL1396-1 and MEL1396-2	
MEL1396-2	Piston Ring Compressor			
MEL1418	Cylinder Hone = 2.00 in	S510 - S850 T550 - T870		
OEM6275	Cylinder Hone = 2.75 - 3.00 in			
OEM6270	Cylinder Hone = 3.00 - 3.50 in			
OEM6271	Cylinder Hone = 3.50 - 4.00 in			

See BobcatDealerNET.com for parts ordering information. (For EMEA dealers see the Bobcat Special Tools Catalogue and Doosan Shop for parts ordering information.)

ST LDR-0219

SERVICE TOOLS REQUIRED (CONT'D)

Hydraulic Tools (Cont'd)

TOOL PART NUMBER	DESCRIPTION	MODELS USED ON	COMMENT	IMAGE
MEL1033	Rod Seal Installation Tool	S70, S100, T110 S450 - S850 T450 - T870 A770		
MEL10006	Hydraulic Test Kit		This test kit includes various adapters and couplers that are used when testing hydraulic functions. MEL10006 Includes: MEL10006-1 thru MEL10006-7	
MEL1278	Detent Tool			
MEL1285	Detent Spring Tool			
MEL1355-2	Pressure Gauge, 1000 psi		S450 - S850 T450 - T870 A770	
MEL1355-3	Pressure Gauge, 5000 psi			
MEL1723	Female Test Coupler		Quick coupler that connects to the hydraulic control valve on the D2 valve.	
MEL1173A	Hydraulic Test Kit	S70	This test kit includes various adapters and couplers that are used when testing hydraulic functions. MEL1173A Includes: MEL1173-1 thru MEL1173-17	
TWX-4004	42mm Thinwall Socket	S450 - S850 T450 - T870 A770	Used to remove and install 42mm couplers on the front auxiliary coupler block.	
7313845 Was 7299828	50mm Coupler Wrench		Used to remove and install 50mm couplers on the front auxiliary coupler block.	
7246786	Female Test Coupler		Quick coupler that connects to the hydraulic control valve on the D2 valve.	

See BobcatDealerNET.com for parts ordering information. (For EMEA dealers see the Bobcat Special Tools Catalogue and Doosan Shop for parts ordering information.)

ST LDR-0219

SERVICE TOOLS REQUIRED (CONT'D)

Hydraulic Tools (Cont'd)













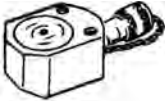

TOOL PART NUMBER	DESCRIPTION	MODELS USED ON	COMMENT	IMAGE
7342781	Lift Cylinder Piston Nut Socket	S450 T450		

See BobcatDealerNET.com for parts ordering information. (For EMEA dealers see the Bobcat Special Tools Catalogue and Doosan Shop for parts ordering information.)

ST LDR-0219

SERVICE TOOLS REQUIRED (CONT'D)

Mainframe And Drive Tools

TOOL PART NUMBER	DESCRIPTION	MODELS USED ON	COMMENT	IMAGE
MEL1399	Seal Driver Tool	S450		
MEL1525	Seal Driver Tool	S70		
MEL1242	Power Ram	S100 S450 - S850		
MEL1202	Axle Bearing Service Set	S70, S100 S450 - S770	MEL1202 Includes: MEL1202-1 thru MEL1202-13	
MEL1714	Axle Seal Installation Tool	S850		
6675936 (MEL1560)	Bleed Tool	T110 - T870	Machines with two track tension fittings.	
7277225	Bleed Tool		Machines with one track tension fittings.	
MEL1246	Chain Link Tool	S450 - S850 A770		
MEL1604	Seal Driver	A770		
MEL1269	Chain Breaker	S450 - S595		
MEL1364	Chain Link Tool	S450 - S595		
MEL1685	Pivot Point Tapered Reamer	S630 - S850 T630 - T870		
MEL1734	Pivot Point Tapered Reamer	S450 - S595 T450 - T595		
MEL1605	Bearing Race Installer	A770		

See BobcatDealerNET.com for parts ordering information. (For EMEA dealers see the Bobcat Special Tools Catalogue and Doosan Shop for parts ordering information.)

ST LDR-0219

SERVICE TOOLS REQUIRED (CONT'D)

Mainframe And Drive Tools (Cont'd)



TOOL PART NUMBER	DESCRIPTION	MODELS USED ON	COMMENT	IMAGE
MEL1730	Bearing Race Remover	S850		
MEL1731	Bearing Race Installer			
MEL1606	Seal Installer	A770		
MEL1420	Carrier Seal installation Tool	S510 - S595		
MEL1612	Bearing Removal Tool	T550 - T595		
MEL1562	Bearing Installation Tool	T630 - T870		
MEL1431	Seal Driver Tool	S630 - S770 A770		
MEL1407	Seal Driver Tool	S630 - S770		
7313844	Cab Isolator Tool	S450 - S850 T450 - T870 A770		
7343587	Drive Motor Seal Installer	MCR5T & MCR6T Drive Motors		

See BobcatDealerNET.com for parts ordering information. (For EMEA dealers see the Bobcat Special Tools Catalogue and Doosan Shop for parts ordering information.)

ST LDR-0219

SERVICE TOOLS REQUIRED (CONT'D)

Mainframe And Drive Tools (Cont'd)





TOOL PART NUMBER	DESCRIPTION	MODELS USED ON	COMMENT	IMAGE
7343588	Drive Motor Seal Installer	MCR10T Drive Motors		
7343752	Skid Steer Loader Drive Shaft Seal Protector	S630-S850 A770 M-Series Loaders		

See BobcatDealerNET.com for parts ordering information. (For EMEA dealers see the Bobcat Special Tools Catalogue and Doosan Shop for parts ordering information.)

ST LDR-0219

SERVICE TOOLS REQUIRED (CONT'D)

Electrical Tools

TOOL PART NUMBER	DESCRIPTION	MODELS USED ON	COMMENT	IMAGE
MEL1609	Wheel Speed	S630 - S850 T630 - T870 A770		
MEL1428	Sensor Tester	S70,S100, T110 S450 - S850 T450 - T870 A770		
MEL1567	Seat Bar Adapter			
7313846 Was 7299829	Injector Signal Tester	S450 - S850 T450 - T870 A770	Used to test injector signal on Bobcat 1.8L, 2.4L and 3.4L engines.	
7299830	Injector Signal Tester	S750 - S850 T750 - T870 A770	Used to test injector signal on Kubota iT4 engines.	

See BobcatDealerNET.com for parts ordering information. (For EMEA dealers see the Bobcat Special Tools Catalogue and Doosan Shop for parts ordering information.)

ST LDR-0219

SERVICE TOOLS REQUIRED (CONT'D)

Engine Tools

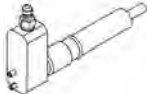
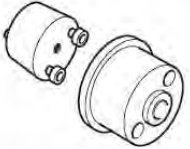









TOOL PART NUMBER	DESCRIPTION	MODELS USED ON	COMMENT	IMAGE
7024161	Diagmaster Kit (iT4 engine only)	S750 - S850 T750 - T870 A770	Includes: DST-i (Diagmaster Service Tool) Vehicle cable (7024272) USB cable (7024271) Diagmaster Diagnostic Software.	
MEL10630	Engine Compression Test Kit	S70,S100, T110 S450 - S650, T450 - T650	Includes: MEL1352, MEL1433, MEL1489, MEL1546, MEL1551, MEL1594, MEL1594, MEL10630-1 - MEL10630-11 and MEL10630-14	
MEL1655	Compression Adapter	S450 - S650 T550 - T650	Used in glow plug port for testing compression, NOT included with MEL10630. Kubota V2607 and V3307 engines.	
MEL1614	Compression Adapter	S750 - S850 T750 - T870 A770	Used in injector port for testing compression, NOT included with MEL10630. Kubota V3300 and V3800 engines.	
MEL1656	Fuel Injection Pump Degree Restoring Tool			
MEL1657	Timing Gear Puller Tool			
7031222	Bobcat Engine Analyzer Diagnostic Tool Kit	T4 Bobcat Engine Applications	Includes: Diagnostic Service Tool (7031223), Vehicle Cable 6 pin (7031398), Vehicle Cable 14 pin (7031356), USB Cable (7031357)	
7031370	Rear Main Seal Installer	Bobcat 1.8L & 2.4L Engine Models Tier 4	Used for installing rear main seal.	
7031369	Front Seal Installer	T4 Bobcat Engine Applications	Used for installing front seal.	

See BobcatDealerNET.com for parts ordering information. (For EMEA dealers see the Bobcat Special Tools Catalogue and Doosan Shop for parts ordering information.)

ST LDR-0219

SERVICE TOOLS REQUIRED (CONT'D)

Engine Tools (Cont'd)





TOOL PART NUMBER	DESCRIPTION	MODELS USED ON	COMMENT	IMAGE
7031371	Valve Spring Compressor	T4 Bobcat Engine Applications	Used for compressing valve springs.	
MEL1733	Pivot Bushing Installer	S510 - S850 T550 - T870	Use to install pivot bushing into flywheel housing.	
4200	Injector Nozzle Tester	S70, S100, T110 S450 - S850 T550 - T870 A770		
4201	Injector Nozzle Tester Adapter Kit			
MEL1173-1	Pressure Gauge 10000 psi	S450 - S850 T550 - T870		
MEL1637	Governor Connecting Rod Tool	S750 - S850 T750 - T870 A770		
MEL1667	Governor Connecting Rod Tool	S510 - S590, S750 - S850 T550, T590, T750 - T870		
MEL1660	Crankshaft Replacement Tool	S510 - S650, T550 - T650		
MEL1237	Fuel Line Adapter	S450 - S550 T450 - T590		
MEL1724	Crankshaft Position Sensor Measuring Tool	S750 - S850 T750 - T870 A770	For checking crankshaft sensor on IT4 Kubota engine.	

See BobcatDealerNET.com for parts ordering information. (For EMEA dealers see the Bobcat Special Tools Catalogue and Doosan Shop for parts ordering information.)

ST LDR-0219

SERVICE TOOLS REQUIRED (CONT'D)

Engine Tools (Cont'd)

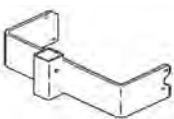
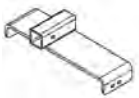
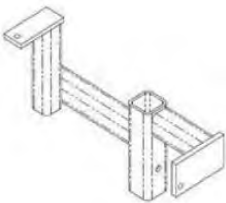
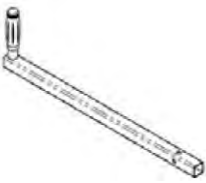
TOOL PART NUMBER	DESCRIPTION	MODELS USED ON	COMMENT	IMAGE
MEL1725	Compression Adapter	S750 - S850 T750 - T870 A770	Used in injector port. For checking compression on IT4 Kubota engine.	
MEL1666	Camshaft Gear Puller	S510 - S550 T550 - T590	Kubota V2607, V3007 and V3307 engines.	
MEL1653-1	Engine Removal Tool	S450 - S850 T450 - T870 A770		
MEL1653-2	Engine Removal Tool	S750 - S850 T750 - T870 A770	T3 Kubota V3800 Engines.	
MEL1653-3	Engine Removal Tool	S450 - S530 T450	Kubota V2203 and V2403 Engines and universal lift adapter.	
MEL1653-4	Engine Removal Tool	S550 - S590 T550 - T590	Kubota V2607 Engines.	
MEL1653-5	Engine Removal Tool	S630, S650 T630, T650	Kubota V3307 Engines.	
MEL1653-6	Engine Removal Tool	S750 - S850 T750 - T870 A770	iT4 Kubota V3800 Engines.	
MEL1653-7	Engine Removal Tool Handle	S740 - S850 T740 - T870 A770	Included with MEL1653-1	

See BobcatDealerNET.com for parts ordering information. (For EMEA dealers see the Bobcat Special Tools Catalogue and Doosan Shop for parts ordering information.)

ST LDR-0219

SERVICE TOOLS REQUIRED (CONT'D)

Engine Tools (Cont'd)









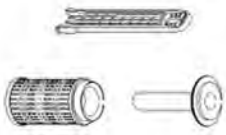

TOOL PART NUMBER	DESCRIPTION	MODELS USED ON	COMMENT	IMAGE
7111805 (Was MEL1686)	Mount (Engine Removal Tool)	S750 - S850 T750 - T870 A770	Used with MEL1653-2	
MEL1653-8	Engine Removal Tool	S740 - S850 T740 - T870 A770	Used with MEL1653-1	
MEL1653-9	Engine Removal Tool	S510 - S595 S630, S650 T550 - T595 T630, T650	2.4L Bobcat Engine Tier 4.	
MEL1653-11	Engine Removal Tool	S750 - S850 T750 - T870 A770	3.4L Bobcat Engine Tier 4 with SCR.	
MEL 1653-12	Engine Removal Tool	S740, T740	3.4L Bobcat Engine Tier 4 without SCR.	
MEL1712	Push Button Starter Switch	S450 - S850 T450 - T870 A770		
MEL1270	Fuel Line Removal Tool	S70		
MEL1271	Delivery Valve Removal Tool			
MEL1485	Injector Removal Socket			
MEL1616	Radiator Tank Test Adapter			
MEL1642	Radiator Cap Test Adapter			

See BobcatDealerNET.com for parts ordering information. (For EMEA dealers see the Bobcat Special Tools Catalogue and Doosan Shop for parts ordering information.)

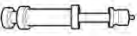
ST LDR-0219

SERVICE TOOLS REQUIRED (CONT'D)

Engine Tools (Cont'd)





TOOL PART NUMBER	DESCRIPTION	MODELS USED ON	COMMENT	IMAGE
7277084	Urea (DEF/AdBlue®) Filter Service Kit	Bobcat 3.4L Engine Models Tier 4 SCR Equipped	Includes: Filter Disassembly Tool, Filter and Equalizer.	
7299831	Compression Adapter	Bobcat 3.4L Engine Models Tier 4	Used in injector port for checking compression.	
7313843	Compression Adapter	Bobcat 1.8L & 2.4L Engine Models Tier 4	Used in glow plug port for checking compression.	
7268212	Valve Lash Adjusting Wrench	All Bobcat Engine Models		
7255632	Valve Stem Seal Tool			
MEL1742	Seal Installer	S450	Drive motor seal installer.	
MEL1607	Snap Ring Installer			
7332314	Turbo and Oil Sensor Block Adapter Kit	All Bobcat Engine Models	7332314 includes: 7332313 - Oil Sensor Block Adapter and 7332298 - Turbo Oil Adapter.	
7357423	Rear Main Seal installer	Bobcat 3.4L Engine Models Tier 4	Used for installing rear main seal.	
7357424	Rear Main Seal Guide		Used for installing rear main seal.	
7357425	Dust Cover Installer		Used for installing Dust Cover.	

See BobcatDealerNET.com for parts ordering information. (For EMEA dealers see the Bobcat Special Tools Catalogue and Doosan Shop for parts ordering information.)

ST LDR-0219

SERVICE TOOLS REQUIRED (CONT'D)

HVAC Tools

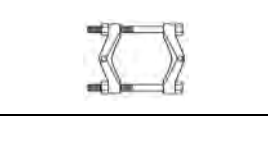
TOOL PART NUMBER	DESCRIPTION	MODELS USED ON	COMMENT	IMAGE
MEL1581	HVAC Recover, Recycling, Recharging Machine	S450 - S850 T450 - T870 A770	MEL1581 is no longer available, order MEL1735 or MEL1736	
MEL1735	Deluxe HVAC Recover, Recycling, Recharging Machine			
MEL1736	Standard HVAC Recover, Recycling, Recharging Machine			
MEL1592	HVAC Refrigerant Identification Tool			
MEL1595	AC Compressor Pulley Puller	S630 - S850 T630 - T870		

See BobcatDealerNET.com for parts ordering information. (For EMEA dealers see the Bobcat Special Tools Catalogue and Doosan Shop for parts ordering information.)

ST LDR-0219

ALPHABETICAL INDEX

(S70) LOADER SPECIFICATIONS	SPEC-10-1	EMERGENCY EXIT	10-230-1
AIR CLEANER SERVICE	10-80-1	ENGINE COOLING SYSTEM	10-90-1
AIR CLEANER	70-40-1	ENGINE COOLING SYSTEM	70-50-1
ALTERNATOR	60-30-1	ENGINE INFORMATION	70-10-1
AUXILIARY CONTROL LOCKBOLT	10-140-1	ENGINE LUBRICATION SYSTEM ...	10-110-1
AUXILIARY HYDRAULIC INTERLOCK VALVE	20-110-1	ENGINE SPEED CONTROL	70-20-1
BACK-UP ALARM SYSTEM (S/N A3W611001 - A3W613689 AND A3W711001 - A3W713379)	60-110-1	FINAL DRIVE TRANSMISSION (CHAINCASE)	10-130-1
BACK-UP ALARM SYSTEM (S/N A3W613690 & ABOVE, A3W713380 & ABOVE, B38V11001 & ABOVE, B38W11001 & ABOVE)	60-111-1	FIRE PREVENTION	1-11
BACK-UP ALARM SYSTEM (S/N B4TY11001 & ABOVE AND B4UC11001 & ABOVE)	60-112-1	FLYWHEEL AND HOUSING	70-110-1
BATTERY	60-20-1	FOREWORD	1-7
BOBCAT CONTROLLER (GATEWAY)	60-80-1	FUEL SYSTEM	10-100-1
BOBCAT INTERLOCK CONTROL SYSTEM (BICS™)	60-70-1	FUEL SYSTEM	70-70-1
BOB-TACH	10-150-1	FUEL TANK	50-70-1
BOB-TACH	50-40-1	HEATER COIL (S/N A3W611001 - A3W613399 AND A3W711001 - A3W713235)	80-50-1
BRAKE	40-10-1	HEATER COIL (S/N A3W613400 & ABOVE, A3W713236 & ABOVE, B38V11001 & ABOVE, B38W11001 & ABOVE, B4TY 11001 & ABOVE AND B4UC 11001 & ABOVE)	80-51-1
BUCKET POSITION VALVE	20-100-1	HEATER FAN (S/N A3W611001 - A3W613399 AND A3W711001 - A3W713235)	80-60-1
CAMSHAFT AND TIMING GEARS	70-100-1	HEATER FAN (S/N A3W613400 & ABOVE, A3W713236 & ABOVE, B38V11001 & ABOVE, B38W11001 & ABOVE, B4TY 11001 & ABOVE AND B4UC 11001 & ABOVE)	80-61-1
CHAINCASE	40-30-1	HEATER SWITCH (S/N A3W611001 - A3W613399 AND A3W711001 - A3W713235)	80-80-1
CHARGE PRESSURE	30-30-1	HEATER SWITCH (S/N A3W613400 & ABOVE, A3W713236 & ABOVE, B38V11001 & ABOVE, B38W11001 & ABOVE, B4TY 11001 & ABOVE AND B4UC 11001 & ABOVE)	80-81-1
CONTROL LEVER	50-100-1	HEATER SYSTEM	80-10-1
CONTROL PANEL	50-90-1	HEATER UNIT (S/N A3W611001 - A3W613399 AND A3W711001 - A3W713235)	80-40-1
CONTROL PEDALS AND LINKAGES	50-80-1	HEATER UNIT (S/N A3W613400 & ABOVE, A3W713236 & ABOVE, B38V11001 & ABOVE, B38W11001 & ABOVE, B4TY 11001 & ABOVE AND B4UC 11001 & ABOVE)	80-41-1
CONVERSIONS	SPEC-60-1	HEATER VALVE (S/N A3W611001 - A3W613399 AND A3W711001 - A3W713235)	80-70-1
CRANKSHAFT AND PISTONS	70-90-1	HEATER VALVE (S/N A3W613400 & ABOVE, A3W713236 & ABOVE, B38V11001 & ABOVE, B38W11001 & ABOVE, B4TY 11001 & ABOVE AND B4UC 11001 & ABOVE)	80-71-1
CYLINDER (LIFT)	20-20-1		
CYLINDER (TILT)	20-21-1		
CYLINDER HEAD	70-80-1		
DELIVERY REPORT	1-14		
DRIVE BELT	30-50-1		
DRIVE COMPONENTS	40-20-1		
ELECTRICAL SYSTEM INFORMATION	60-10-1		

HYDRAULIC / HYDROSTATIC FILTER	20-70-1	REMOTE START TOOL (SERVICE TOOL) KIT -7217666	10-61-1
HYDRAULIC / HYDROSTATIC FLUID SPECIFICATIONS	SPEC-50-1	REMOTE START TOOL KIT - MEL1563	10-60-1
HYDRAULIC CONNECTION SPECIFICATIONS	SPEC-40-1	SAFETY INSTRUCTIONS	1-9
HYDRAULIC CONTROL VALVE	20-40-1	SEAT BAR RESTRAINT SYSTEM ..	10-200-1
HYDRAULIC FLUID RESERVOIR	20-80-1	SEAT BAR SENSOR	60-90-1
HYDRAULIC PUMP	20-60-1	SEAT BAR	50-10-1
HYDRAULIC SYSTEM INFORMATION	20-10-1	SEAT BELT	10-240-1
HYDRAULIC / HYDROSTATIC SYSTEM	10-120-1	SERIAL NUMBER LOCATIONS	1-13
HYDROSTATIC DRIVE MOTOR	30-20-1	SERVICE SCHEDULE	10-70-1
HYDROSTATIC PUMP	30-40-1	SERVICE TOOLS REQUIRED	SPEC-70-1
HYDROSTATIC SYSTEM INFORMATION	30-10-1	SPARK ARRESTER MUFFLER	10-180-1
INSTRUMENT PANELS	60-50-1	STARTER	60-40-1
LIFT ARM BYPASS CONTROL VALVE	20-50-1	STOPPING THE ENGINE AND LEAVING THE LOADER	10-220-1
LIFT ARM SUPPORT DEVICE	10-20-1	TECHNICAL SERVICE GUIDE SPECIFICATIONS	SPEC-20-1
LIFT ARMS	50-50-1	TIRE MAINTENANCE	10-170-1
LIFTING AND BLOCKING THE LOADER	10-10-1	TORQUE SPECIFICATIONS FOR BOLTS	SPEC-30-1
LIGHTS	60-60-1	TOWING THE LOADER	10-50-1
LOADER IDENTIFICATION	1-15	TRACTION LOCK	60-100-1
LOADER STORAGE AND RETURN TO SERVICE	10-210-1	TRANSPORTING THE LOADER ON A TRAILER	10-40-1
LUBRICATING THE LOADER	10-160-1	TROUBLESHOOTING	80-30-1
LUBRICATION SYSTEM	70-60-1	WINDOW (REAR)	50-110-1
MAIN RELIEF VALVE	20-30-1	WINDOW (TOP)	50-111-1
MAINTENANCE SAFETY	1-1		
MUFFLER	70-30-1		
OIL COOLER	20-90-1		
OPERATOR CAB	10-30-1		
OPERATOR CAB	50-20-1		
OPERATOR SEAT	50-30-1		
PIVOT PINS	10-190-1		
REAR DOOR	50-60-1		
REGULAR MAINTENANCE (S/N A3W611001 - A3W613399 AND A3W711001 - A3W713235)	80-20-1		
REGULAR MAINTENANCE (S/N A3W613400 & ABOVE, A3W713236 & ABOVE, B38V11001 & ABOVE, B38W11001 & ABOVE, B4TY 11001 & ABOVE AND B4UC 11001 & ABOVE)	80-21-1		

Bobcat[®], the Bobcat logo and the colors of the Bobcat machine are registered trademarks of Bobcat Company in the United States and various other countries.