

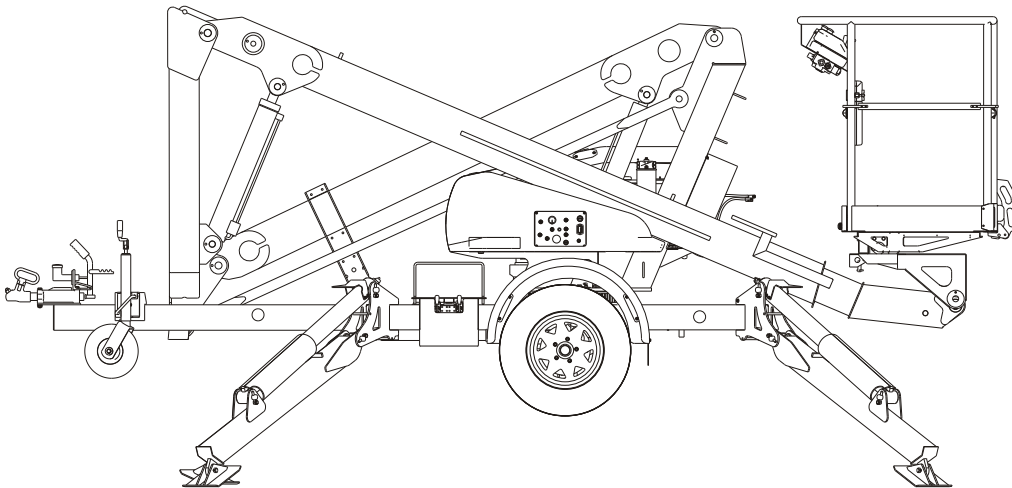

MHP14AT
MHP13AT



Diesel
Gasoline
Battery Electric
Bi-Energy Options

OPERATION MANUAL

Part Number 13618-1

August 2011 (Rev A)

Serial Number NZ110108 and after

LIMITED WARRANTY

Snorkel warrants each new machine manufactured and sold by it to be free from defects in material and workmanship for a period of one (1) year from date of delivery to a Customer or for one year after the machine has been placed in first service in a Dealer rental fleet, whichever comes first. Any part or parts which, upon examination by the Snorkel Service Department, are found to be defective, will be replaced or repaired, at the sole discretion of Snorkel, through its local Authorized Dealer at no charge.

Snorkel further warrants the structural components; specifically, the mainframe chassis, turntable, booms and scissor arms, of each new machine manufactured by it to be free from defects in material and workmanship for an additional period of four (4) years. Any such part or parts which, upon examination by the Snorkel Service Department, are found to be defective will be replaced or repaired by Snorkel through its local Authorized Dealer at no charge; however, any labor charges incurred as a result of such replacement or repair will be the responsibility of the Customer or Dealer.

The Snorkel Service Department must be notified within forty-eight (48) hours of any possible warranty situation during the applicable warranty period. Personnel performing warranty repair or replacement must obtain specific approval by Snorkel Service Department prior to performing any warranty repair or replacement.

Customer and Dealer shall not be entitled to the benefits of this warranty and Snorkel shall have no obligations hereunder unless the "Pre-Delivery and Inspection Report" has been properly completed and returned to the Snorkel Service Department within ten (10) days after delivery of the Snorkel product to Customer or Dealer's rental fleet. Snorkel must be notified, in writing, within ten (10) days, of any machine sold to a Customer from a Dealer's rental fleet during the warranty period.

At the direction of the Snorkel Service Department, any component part(s) of Snorkel products to be replaced or repaired under this warranty program must be returned freight prepaid to the Snorkel Service Department for inspection. All warranty replacement parts will be shipped freight prepaid (standard ground) from the Snorkel Service Department or from Snorkel's Vendor to Dealer or Customer.

REPLACEMENT PARTS WARRANTY

Any replacement or service part made or sold by Snorkel is not subject to the preceding **Limited Warranty** beyond the normal warranty period of the machine upon which the part was installed.

THIS WARRANTY EXCLUDES AND SNORKEL DOES NOT WARRANT:

1. Engines, motors, tires and batteries which are manufactured by suppliers to Snorkel, who furnish their own warranty. Snorkel will, however, to the extent permitted, pass through any such warranty protection to the Customer or Dealer.
2. Any Snorkel product which has been modified or altered outside Snorkel's factory without Snorkel's written approval, if such modification or alteration, in the sole judgment of Snorkel's Engineering and/or Service Departments, adversely affects the stability, reliability or service life of the Snorkel product or any component thereof.
3. Any Snorkel product which has been subject to misuse, improper maintenance or accident. "Misuse" includes but is not limited to operation beyond the factory-rated load capacity and speeds. "Improper maintenance" includes but is not limited to failure to follow the recommendations contained in the Snorkel Operation, Maintenance, Repair Parts Manuals. Snorkel is not responsible for normal maintenance, service adjustments and replacements, including but not limited to hydraulic fluid, filters and lubrication.
4. Normal wear of any Snorkel component part(s). Normal wear of component parts may vary with the type application or type of environment in which the machine may be used; such as, but not limited to sandblasting applications.
5. Any Snorkel product that has come in direct contact with any chemical or abrasive material.
6. Incidental or consequential expenses, losses, or damages related to any part or equipment failure, including but not limited to freight cost to transport the machine to a repair facility, downtime of the machine, lost time for workers, lost orders, lost rental revenue, lost profits or increased cost.

This warranty is expressly in lieu of all other warranties, representations or liabilities of Snorkel, either expressed or implied, unless otherwise amended in writing by Snorkel's President, Vice President-Engineering, Vice President-Sales or Vice President-Marketing.

SNORKEL MAKES NO WARRANTIES WHICH EXTEND BEYOND THE DESCRIPTION OF THIS LIMITED WARRANTY. SNORKEL MAKES NO IMPLIED WARRANTY OF MERCHANTABILITY OR FITNESS FOR A PARTICULAR PURPOSE AND DISCLAIMS ALL LIABILITY FOR INCIDENTAL OR CONSEQUENTIAL DAMAGES, INCLUDING BUT NOT LIMITED TO INJURY TO PERSONS OR PROPERTY.

The Customer shall make all warranty claims through its local Authorized Dealer and should contact the Dealer from whom the Snorkel product was purchased for warranty service. Or, if unable to contact the Dealer, contact the Snorkel Service Department for further assistance.

■ Electrical Hazard Warning



DANGER

THE MHP14AT / MHP13AT AERIAL WORK PLATFORM, IN STANDARD CONFIGURATION, IS NOT ELECTRICALLY INSULATED.

If the platform, booms, or any other conductive part of a MHP14AT / MHP13AT contacts a high-voltage electrical conductor, the result can be **SERIOUS INJURY** or **DEATH** for persons on or near the machine.



GO NO CLOSER THAN THE MINIMUM SAFE APPROACH DISTANCES (M.S.A.D) - AS OUTLINED IN TABLE 1. AND FIGURE 3., ON THE NEXT PAGE.

Be sure to allow for sag and sway in the wires and the work platform.

If a MHP14AT / MHP13AT comes in contact with a live electrical conductor, the entire machine can be charged.

If that happens, you should remain on the machine and not contact any other structure or object within reach. That includes the ground, adjacent buildings, poles, and any object not a part of the MHP14AT / MHP13AT.

Such contact could make your body a conductor to the other object creating an electrical shock hazard resulting in **SERIOUS INJURY** or **DEATH**.

DO NOT attempt to enter or leave the MHP14AT / MHP13AT until you are sure the electricity has been turned off.

If a MHP14AT / MHP13AT is in contact with a live conductor, the platform operator **MUST** warn others on the ground in the vicinity of the MHP14AT / MHP13AT to **STAY AWAY** from the machine, since their bodies can also form a path for electricity to ground thus creating an electrical shock hazard with possible **ELECTROCUTION** and **DEATH**.

DO NOT attempt to operate the MHP14AT / MHP13AT ground controls when the platform, booms, or any other conducting part of a MHP14AT / MHP13AT is in contact with electrical wires or if there is an immediate danger of such contact.

Regard all conductors as energized.

Personnel working on or near a MHP14AT / MHP13AT must be continuously aware of electrical hazards, recognizing that **SERIOUS INJURY** or **DEATH** can result if contact with an electrical wire does occur.

Electrical Hazard

■ Minimum Safe Approach Distance

The MHP14AT / MHP13AT is an all metal boom, **NOT ELECTRICALLY INSULATED**, aerial work platform. **DO NOT** operate it near **ELECTRICAL** conductors. Regard all conductors as being energized. Use the table and illustration below to determine safe clearance from electrical conductors. (Table 1 and Figure 3, below, are from ANSI/SIA A92.5–1992 Standard, reprinted with permission of Scaffold Industry Association.)

□ Table 1 - (M.S.A.D.)

**Minimum Safe Approach Distance
to energized (exposed or insulated power lines)**

Voltage range (phase to phase)	Minimum safe approach distance	
	(Feet)	(Meters)
0 to 300V	Avoid contact	
over 300v to 50kv	10	3.05
over 50kv to 200kv	15	4.60
over 200kv to 350kv	20	6.10
over 350kv to 500kv	25	7.62
over 500kv to 750kv	35	10.67
over 750kv to 1000kv	45	13.72

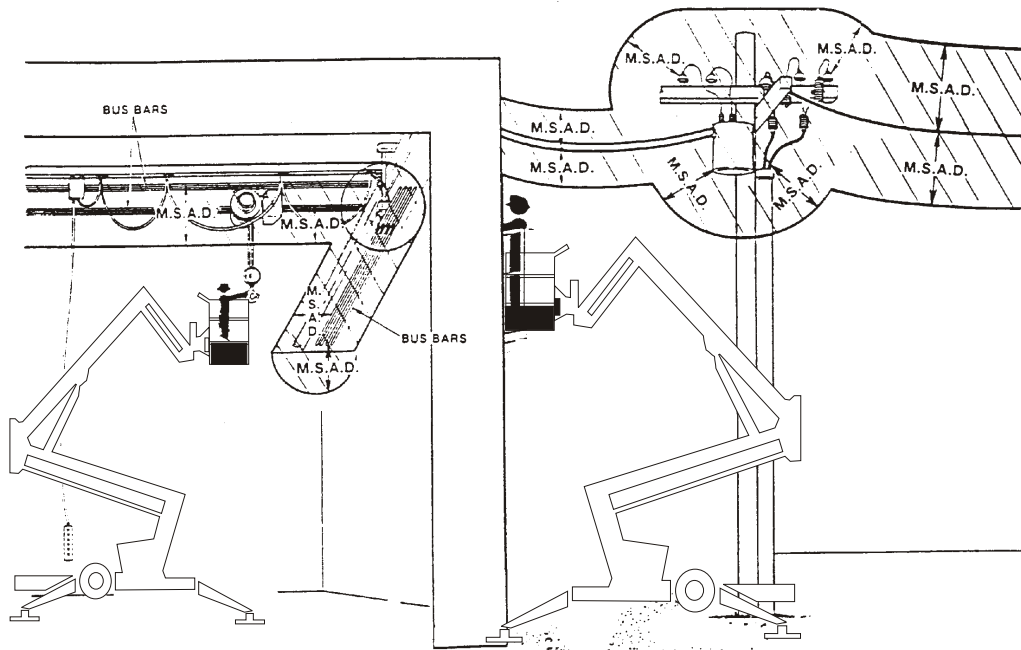

Denotes prohibited zone

- Danger:**
- Do not allow machine personnel or conductive materials inside prohibited zone.
 - Maintain M.S.A.D. From all energised lines and parts as well as those shown.
 - Assume all electrical parts and wires are energised unless known otherwise.
- Caution:**
- Diagrams shown are only for purposes of illustrating M.S.A.D. Work positions, not all work positions.

The most important chapter in this manual is the safety chapter - Chapter 1. Take time, now, to study it closely.

The information in Chapter 1, might save your life, prevent serious injury, or damage to property or the MHP14AT / MHP13AT.

This introduction also contains important information concerning the responsibilities of the owner of this machine.

■ Standard MHP14AT / MHP13AT

The standard MHP14AT / MHP13AT includes the following features:

- Independently operated heavy duty hydraulic stabilisers
- Manual stabilisers
- 540° slew
- Heavy duty tow coupling
- Heavy duty jockey wheel
- Hour meter
- Hydraulic disc brakes
- Steel platform - 2 person capacity
- High strength steel boom and base construction
- Beam axle with 15" rims
- Honda petrol engine
- 600V AC rated wire to platform
- Stabiliser/boom interlocks
- Stabiliser lift points
- Gravity gate
- LED taillights
- Height restrictor in upper cylinder to keep platform at 10.9m maximum height (MHP13AT only)
- 235 R15 x 75 tyres
- Platform overload protection

■ Options

The following options are available for the MHP14AT / MHP13AT:

- Automatic stabilisers
- Custom colours
- Platform work lights
- Air line to platform
- Flashing light
- Spare wheel
- 10.9m height lockout kit
- 240V/110V outlet in platform
- Battery isolate switch

- Platform foot switch
- Alternative power options
 - Diesel engine
 - 24VDC power
 - 240V power
 - 110V power
- Bi-Energy options
 - Petrol / 24V
 - Petrol / 240V
 - Diesel / 24V
 - Diesel / 240V
 - 24V / 240V
- Platform rotator

■ Operation Manual

This manual provides information for safe and proper operation of the aerial platform.

Read and understand the information in this Operator's manual before operating this machine on a job site.

Additional copies of this manual may be ordered from Snorkel. Supply the model and manual part number from the front cover to assure that the correct manual will be supplied.

All information in this manual is based on the latest product information at the time of publication. Snorkel reserves the right to make product changes at any time without obligation.

■ Photographs

Photographs are taken to represent the machine and its component parts as clearly as possible. However, there may be minor differences between the photographs and your machine. This represents individual customer preferences and Snorkel's on-going commitment to product development.

■ Safety Alerts

A safety alert symbol is used throughout this manual to indicate danger, warning, caution, and important instructions. Follow these instructions to reduce the likelihood of personal injury, property damage, or damage to the machine.

The terms danger, warning, and caution indicate varying degrees of personal injury or property damage that can result if the instruction is not followed.

▲ DANGER

Denotes an imminently hazardous situation which, if not avoided, will result in death or serious injury.

Introduction

▲ WARNING

Denotes a potentially hazardous situation which, if not avoided, could result in death or serious injury.

▲ CAUTION

Denotes a potentially hazardous situation which, if not avoided, may result in minor or moderate injury.

It may also be used to alert against unsafe practices or action which may result in damage to the MHP.

▲ IMPORTANT

Denotes important information pertaining to settings, capacities, or conditions, which could, if ignored, lead to machine damage or future hazardous situations.

It is also used to alert the reader to pay careful attention to a particular passage of text in the manual.

Notes

Notes are used to provide special information or helpful hints to assist in aerial platform operation, but do not indicate a hazardous situation.

■ Operation

The MHP aerial platform has built-in safety features and has been factory tested for compliance with Snorkel specifications and industry standards. However, any personnel lifting device can be potentially dangerous in the hands of untrained or careless operators.

Training is vitally important and must be performed under the direction of a QUALIFIED person. You must display proficiency in knowledge and actual operation of the MHP before using it on a job site.

Before operation of the MHP you must read and understand the operating instructions in this manual as well as the decals, warnings, and instructions on the machine itself.

Before operating the MHP you must be AUTHORIZED by the person in charge to do so and the operation of the MHP must be within the scope of the machine specifications.

▲ WARNING

The potential for an accident increases when the aerial platform is operated by personnel who are not trained and authorised. death or

serious injury can result from such accidents.

Read and understand the information in this manual and on the placards and decals on the machine before operating the MHP on the job.

■ Maintenance

Every person who maintains, inspects, tests, or repairs these machines, and every person supervising any of these functions, must be properly trained and qualified to do so.

This Operators Manual provides a Pre-operational Inspection procedure that will help you keep your MHP in good operating condition.

Do not perform other maintenance unless you are a trained mechanic, qualified to work on the MHP. Call qualified maintenance personnel if you find problems or malfunctions.

Do not modify this machine without written approval from the Engineering Department of Snorkel New Zealand. Modification may void the warranty, adversely affect stability, or affect the operational characteristics of the MHP.

■ Responsibilities of Parties

▲ IMPORTANT

It is imperative that all owners and users of the MHP read, understand, and conform to all applicable regulations.

Ultimate compliance to OSHA regulations is the responsibility of the user and their employer.

▲ IMPORTANT

ANSI Standard A92.6 clearly identifies requirements of all parties who might be involved with Self-Propelled Elevating Work Platforms.

AUSTRALIAN / NZ STANDARD 2550-10 Also identifies the requirements of all parties who might be involved with Boom-Supported Elevating Work Platforms.

NOTE - Standards

It is the responsibility of the owner to ensure that the person operating the MHP14AT / MHP13AT is provided with all the relevant information relating to standards and codes of practice applicable in their region.

□ In summary

- Only trained and authorised operators should be permitted to operate the equipment.
- All manufacturers operating instructions, and all safety rules, and all employers safety rules, and all OSHA and other government or local authority safety rules should be strictly adhered to.
- Repairs and adjustments should be made only by qualified and trained maintenance personnel.
- No modification should be made to the equipment without prior written consent of the Engineering Department, Snorkel New Zealand.
- Make a pre-start inspection of the MHP at the beginning of each shift. A malfunctioning machine must not be used.
- Make an inspection of the work place to locate possible hazards before operating the MHP.

■ Additional Information

For additional information, contact your local dealer or Snorkel at:

Snorkel New Zealand,
PO Box 1041
Levin 5540
New Zealand

Electrical Hazard

Electrical Hazard Warning i
 Minimum Safe Approach Distance ii
 Table 1 - (M.S.A.D.) ii

Introduction

Standard MHP14AT / MHP13AT iii
 Options iii
 Operation Manual. iii
 Photographs. iii
 Safety Alerts. iii
 Operation iv
 Maintenance iv
 Responsibilities of Parties iv
 In summary. v
 Additional Information. v

1. Safety

Safe Operation 1-1
 Electrocutation Hazards 1-1
 Minimum safe approach distance 1-1
 Pre-start Inspection 1-2
 Work Place Inspection and Practices 1-2
 Operation. 1-3
 Tipover and Falling Hazards 1-3
 General Safety Precautions 1-4
 Hydraulic System Precautions 1-4
 Fire Prevention 1-4
 Engine and Fuel Handling Precautions. 1-4
 Batteries 1-4
 Height Restriction 1-5
 Height Restriction on MHP13AT 1-5
 10.9 Metre Restriction Kit 1-5
 Safety Decals and Placards 1-5

2. Safety Devices

Safety Device Information 2-1
 Emergency Stop Switches 2-1
 At ground control box 2-1
 At platform control box 2-1
 Other Safety Devices 2-1
 Lanyard anchor points 2-1
 Gravity gates. 2-2
 Guardrails 2-2
 Height restriction on MHP13AT 2-2
 10.9m height restriction kit (Option) 2-2
 Enable switch 2-2
 Enable switch (foot) - Optional 2-3
 Platform Overload Protection 2-3
 Bubble level 2-3
 RCD/ELCB AC outlet (Option) 2-3
 Flashing light (Option). 2-4

3. Specifications

General Specifications 3-1
 Specifications MHP14AT. 3-1
 Specifications MHP13AT. 3-2
 Engine Data. 3-3
 Working Envelope - MHP14AT, MHP13AT. 3-4
 Nomenclature 3-5

4. Gauges

Hourmeter 4-1
 Level Bubble 4-1
 Hydraulic Oil Level 4-1

5. Shut-offs and Circuit Breakers

RCD/ELCB Outlet (option) 5-1
 Stabilisers 5-1
 Electrical Circuit Protection 5-1

6. Controls

Controls Description 6-1
 Controls and Control Decal Locations 6-1
 Ground Control Box. 6-2
 Lower controls / indicators: 6-2
 Platform Control Box 6-3
 Upper controls / indicators: 6-3
 Stabiliser Controls (Manual) 6-5
 Self Levelling Stabilisers (Option). 6-5

7. Pre-operational Inspection

Pre-operational Inspection Table 7-1
 Engine Fuel Level 7-2
 Fuel Tank Cap. 7-2
 Fuel Leaks. 7-2
 Engine Oil Level 7-2
 Operator's Manual. 7-2
 Wiring Harnesses 7-2
 Battery Terminals 7-3
 Battery Fluid Level. 7-3
 Hydraulic Oil Level 7-3
 Hydraulic Oil Leaks 7-3
 Bolts and Fasteners 7-4
 Wheels and Tyres 7-4
 Tyre Pressure 7-4
 Structural Damage and Welds 7-5
 Lanyard Anchor Points 7-5
 Platform Gravity Gates 7-5
 Platform Guardrails 7-5
 Platform Access Step 7-5
 Flashing Light (option). 7-6
 Ground Control Switches 7-6
 Emergency Lower 7-6
 Ground Station 7-6
 Upper control box 7-6

Table of Contents

Platform Control Switches	7-7	Bi-Energy, Petrol/Diesel / 240V AC	11-3
AC Outlet RCD/ELCB (option)	7-7	AC motor	11-3
Placards and Decals	7-7	AC motor operation	11-3
Placards and Decals	7-7	AC power connection	11-4
Standard placards and decals	7-7	Operation	11-4
Decal list	7-8	Bi-Energy, Hydraulic Oil Tank.	11-4
Decal inspection drawing	7-9	Other Options	11-4
8. Operation		Air Line To Platform.	11-4
Operating Procedures	8-1	Work Lights	11-4
Control Stations.	8-1	Flashing Light	11-4
Emergency Stopping.	8-1	Battery Isolate Switch	11-4
Emergency Stopping.	8-1	Alternative Power Options.	11-4
Operation Considerations	8-1	RCD/ELCB AC Outlet	11-4
Stabiliser Operation.	8-1	Self Levelling Stabiliser	11-5
Using the manual stabiliser valves	8-2	Spare Wheel	11-5
Raising the manually operated stabilisers	8-2	Platform Foot Switch	11-5
Self levelling stabilisers (Optional)	8-3	Platform Rotator	11-5
Setting the stabilisers manually	8-3	10.9 Metre Height Restriction Kit	11-6
Unlocking the boom.	8-3	12. Fire Fighting and Chemical Control	
Starting From Ground Control Box	8-3	Hazardous Components	12-1
Starting From Platform Control Box	8-4	Battery, Lead/Acid (UN 2794).	12-1
Moving The Platform	8-5	Gasoline (UN 1203)	12-2
From ground control box.	8-5	Hydraulic Oil (UN 1270)	12-3
From platform control box.	8-6	Motor Oil (UN 1270)	12-3
Securing for Day	8-6	13. Operator's Troubleshooting	
9. Emergency Operation		Troubleshooting.	13-1
Emergency Operation Procedures	9-1	Operator Troubleshooting Chart.	13-1
Emergency Operation Procedures	9-1	Appendix A. Glossary	
Operation from platform control box	9-1		
Operation from ground control position	9-2		
10. Stowing and Transporting			
Stowing	10-1		
The correct stowed position is shown here.	10-1		
Transporting	10-1		
Trailing	10-1		
Securing to a Transport Vehicle	10-1		
Towing.	10-2		
11. Options			
Bi-Energy, Petrol/Diesel / 24V DC	11-1		
DC motor.	11-1		
DC motor operation.	11-1		
DC motor battery switch	11-1		
Setting the manual stabilisers.	11-1		
Setting the automatic stabilisers.	11-1		
Operation	11-2		
Batteries	11-2		
Battery charger	11-2		
Batteries - general maintenance.	11-3		
Batteries - charging.	11-3		

■ Safe Operation

Knowledge of the information in this manual, and proper training, provide a basis for safely operating the MHP14AT / MHP13AT. Know the location of all the controls and how they operate to act quickly and responsibly in an emergency.

Safety devices reduce the likelihood of an accident. Never disable, modify, or ignore any safety device. Safety alerts in this manual indicate situations where accidents may occur.

If any malfunction, hazard or potentially unsafe condition relating to capacity, intended use, or safe operation is suspected, stop the operation of the MHP and seek assistance.

The operator bears ultimate responsibility for following all manufacturers instructions and warnings, regulations and safety rules of their employer and/or any country or regional law.

■ Electrocution Hazards

The MHP14AT / MHP13AT is an all metal boom aerial work platform and **is not electrically insulated**.

Do not operate it near electrical conductors.

Regard all conductors as being energized.

Do not operate outside during a thunderstorm.

□ Minimum safe approach distance

Minimum safe approach distances to energised power lines and their associated parts must be observed while operating the MHP.

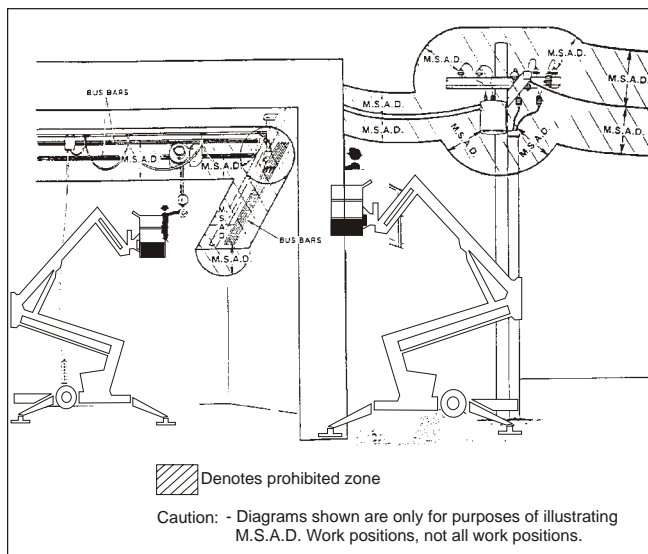

Figure 1 - Minimum Safe Approach Distance ANSI A92.5

▲ DANGER

The MHP is not electrically insulated. Death or serious injury can result from contact with, or inadequate clearance from, an energised conductor.

Do not go closer than the minimum safe approach distance.

ANSI publications define minimum distances that must be observed when working near bus bars and energised power lines. Figure 1 and Table 1 are reprinted courtesy of the Scaffold industry Association, ANSI/SIA A92.5.

Voltage Range (Phase to Phase)	Minimum Safe Approach Distance	
	Feet	Metres
0 to 300V	Avoid Contact	
Over 300V to 50kV	10	3.05
Over 50kV to 200kV	15	4.60
Over 200kV to 350kV	20	6.10
Over 350kV to 500kV	25	7.62
Over 500kV to 750kV	35	10.7

Table 1 - Minimum Safe Approach Distance ANSI 92.5

Australian Standard AS 2550.10 defines minimum distances that must be observed when working near live aerial conductors up to and including 133kV (see Figure 2).

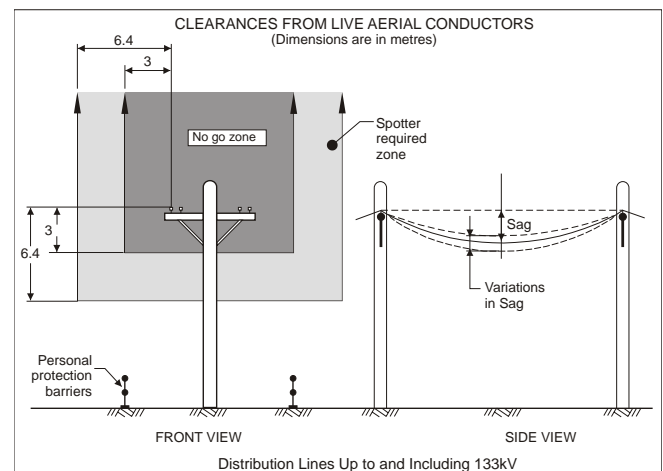

Figure 2 - Minimum Safe Approach Distance AS 2550.10

1. Safety

■ Pre-start Inspection

At the start of each work shift, the MHP14AT / MHP13AT shall be given a visual inspection and function test. See the “Pre-operational Inspection and Maintenance” chapter 7, in this manual for a list of items to inspect and test.

▲ WARNING

DO NOT operate the MHP14AT / MHP13AT unless you are trained and authorized, understand the operation characteristics of the MHP14AT / MHP13AT, and have inspected and tested all functions to be sure they are in proper working order.

▲ DANGER

NEVER use an MHP14AT / MHP13AT that has a known fault or is malfunctioning in any way until the machine has been repaired by a qualified technician.

Operating a machine in faulty condition could result in death or serious injury.

NOTE:

Whilst some of the safety rules and guidelines that follow may not apply specifically to this machine (e.g. references to driving) they are included as part of an overall safety strategy relating to the use of elevating work platforms.

■ Work Place Inspection and Practices

Do not use the MHP14AT / MHP13AT as a ground for welding. Ground to the work piece.

Before the MHP14AT / MHP13AT is used, and during use, check the area in which the MHP14AT / MHP13AT is to be used for possible hazards such as, but not limited to:

- Drop-offs or holes.
- Side slopes.
- Bumps and floor obstructions.
- Debris.
- Overhead obstructions and electrical conductors.
- Hazardous locations.
- Inadequate surface and support to withstand all load forces imposed by the aerial platform in all operating configurations.
- Wind and weather conditions.
- Presence of unauthorized persons.
- Other possible unsafe conditions.

Before the MHP14AT / MHP13AT is used, determine the hazard classification of any particular atmosphere or location according to ANSI/NFPA 505.

Any MHP14AT / MHP13AT operated in a hazardous location must be approved and of the type required by ANSI/NFPA 505.

While operating the MHP a recommended safety practice is to have trained and qualified personnel in the immediate work area of the MHP14AT / MHP13AT to:

- Help in case of an emergency.
- Operate emergency controls as required.
- Watch for loss of control by platform operator.
- Warn the operator of any obstructions or hazards that may not be obvious to them.
- Watch for soft terrain, sloping surfaces, drop-offs, etc., where stability could be jeopardized.
- Watch for bystanders and never allow anyone to be under, or to reach through the booms while operating the aerial platform.

▲ DANGER

Pinch points may exist between moving components. Death or serious injury can result from becoming trapped between components, buildings, structures, or other obstacles. Make sure there is sufficient clearance around the machine before moving the chassis, booms, or platform. Allow sufficient room and time to stop movement to avoid contact with structures or other hazards.

Keep ground personnel from under the platform when the platform is raised.

Secure all accessories, containers, tools, and other materials in the platform to prevent them from accidentally falling or being kicked off the platform.

Always look in the direction of travel. Drive with care and at speeds compatible with the work-place conditions. Use caution when driving over rough ground, on slopes, and when turning.

Do not engage in any form of “horseplay” or “stunt driving” while operating the MHP14AT / MHP13AT.

Do not permit riders on the machine anywhere other than on the platform.

Remove all loose objects stored in or on the machine, particularly in the platform. Remove all objects which do not belong in or on the machine.

Never steady the platform by positioning it against another platform.

Do not operate an MHP14AT / MHP13AT that is damaged or not functioning properly. Do not use the MHP until the machine has been repaired by a qualified maintenance person.

Do not operate a MHP14AT / MHP13AT that does not have all its decals and placards attached and legible.

Watch for bystanders and never allow anyone to be under, or to reach through, the machine and its equipment while operating.

Use the recommended transport device when loading the machine.

■ Operation

If you encounter any suspected malfunction of the aerial platform, or any hazard or potentially unsafe condition relating to capacity, intended use, or safe operation, cease operation immediately and seek assistance from management.

Use three points of support when getting on or off the platform (two hands and one foot or a similar set of points). Keep the platform clean.

Maintain a firm footing on the platform floor. Operate the controls slowly and deliberately to avoid jerky and erratic operation. Always stop the controls in neutral before going in the opposite direction.

Do not dismount while the platform is in motion or jump off the machine.

Do not start until all personnel are clearly away from the machine.

Never cover the floor grating or otherwise obstruct your view below. Make sure the area below the platform is free of personnel before lowering.

■ Tipover and Falling Hazards

Operate the MHP only on a firm, flat, level surface capable of withstanding all load forces imposed by the MHP14AT / MHP13AT in all operating conditions.

▲ DANGER

The MHP can tip over if it becomes unstable. Death or serious injury can result from a tip-over accident. Do not drive or position the MHP platform for elevated use near any drop-off, hole, slope, soft or uneven ground, or other tip-over hazard.

Do not operate the MHP14AT / MHP13AT from a position on trucks, trailers, railway cars, floating vessels, scaffolds, or similar equipment unless the application is approved in writing by Snorkel.

Care shall be taken to prevent rope, electric cords, and hoses, etc., from becoming entangled in the aerial platform. If the platform or elevating assembly becomes caught, snagged, or otherwise prevented from normal motion by an adjacent structure or other obstacle such that control reversal does not free the platform, remove all personnel from the platform before attempts are made to free the platform using ground controls.

Under normal working conditions it is best not to transfer from the platform to another structure or vice versa, unless that is the safest way to do the job. Each situation must be judged separately taking the work environment into account. The following guidelines apply:

1. Where possible, place the work platform over a roof or walking structure to do the transfer.
2. Transfer your anchorage from one structure to another before you step across.
3. Remember, you might be departing the work platform to a structure where fall arrest is required.
4. Do not climb over or through the guardrails. Use the platform entrance.

All platform occupants **MUST** wear and use fall restraint. Attach fall restraints to the platform lanyard anchor points.

Do not exceed the unrestricted platform capacity as indicated on the capacity placard at the entrance to the platform. Do not carry loads from any point outside of the platform.

Make sure that all protective guards, cowlings, and doors are in place and secure. Be sure the guard-rail system, including the gate, is in place and secure.

Do not climb on the guardrails or use ladders, planks, or other devices to extend or increase your work position from the platform.

Do not use the MHP as a crane, hoist, or jack, or for any other purpose other than to position personnel, their tools, and materials.

Do not operate the MHP14AT / MHP13AT in winds, or wind gusts, of 28 mph, 45kph 12.5 m/s) or more.

▲ DANGER

Do not add banners, flags, screens or shelters etc., to areas of the MHP that are

1. Safety

exposed to wind forces as this will increase the wind loading and effect stability.

■ General Safety Precautions

Do not modify the MHP14AT / MHP13AT in any way.

When parts or components are replaced, they shall be identical or equivalent to original Snorkel parts or components.

Do not override any of the safety features of the MHP14AT / MHP13AT.

■ Hydraulic System Precautions

The hydraulic system contains hoses with hydraulic fluid under pressure.

▲ DANGER

Hydraulic fluid escaping under pressure can have enough force to inject fluid into the flesh. Serious infection or reaction can result if medical treatment is not given immediately. In case of injury by escaping hydraulic fluid, seek medical attention at once.

DO NOT place your hand or any part of your body in front of escaping hydraulic fluid. Use a piece of cardboard or wood to search for hydraulic leaks.

Do not attempt repairs to hydraulic systems unless you are trained. Refer to experienced repair personnel for help.

■ Fire Prevention

Never operate your MHP near a flame or spark. Hydraulic oil and gasoline are flammable and can explode.

NOTE:

This machine is equipped with an internal combustion engine (in it's standard configuration) and should not be used on or near any unimproved forest-covered, brush-covered or grass covered land unless the engine's exhaust system is equipped with a spark arrester meeting applicable laws. If a spark arrester is used, it should be maintained in effective working order by the operator.

■ Engine and Fuel Handling Precautions

▲ WARNING

Engine exhaust contains carbon monoxide, a poisonous gas that is invisible and odorless. Breathing engine exhaust fumes

can cause death or serious illness. Do not run the engine in an enclosed area or indoors without adequate ventilation.

Only refuel your MHP outdoors in a clear area void of gas fumes or spilled gas.

Never remove the fuel cap or refuel a gasoline engine while the engine is running or hot. ALWAYS allow the engine to cool before refueling. Never allow fuel to spill on hot machine components.

▲ DANGER

DO NOT smoke or permit open flames while fueling or near fueling operations.

Maintain control of the fuel filler nozzle when filling the tank.

▲ CAUTION

ENSURE you use an approved fuel container with appropriate fuel filler nozzle (see picture below)



Do not fill the fuel tank to capacity. Allow room for expansion.

If gasoline is spilled, clean up spilled fuel immediately, push/tow the MHP away from the area of the spill and avoid creating any source of ignition until the spilled fuel has evaporated.

Tighten the fuel tank cap securely. If the fuel cap is lost, replace it with an approved cap from Snorkel. Use of a non-approved cap without proper venting may result in pressurization of the tank.

Never use fuel for cleaning purposes.

For diesel engines, use the correct fuel grade for the operating season.

■ Batteries

Charge batteries in a well ventilated area free of flame, sparks, or other hazards that might cause fire or explosion.

▲ WARNING

Batteries give off hydrogen and oxygen that can combine explosively. Death or serious injury can result from a chemical explosion. Do not smoke or permit open flames or sparks when checking batteries.

▲ CAUTION

Battery acid can damage the skin and eyes. Serious infection or reaction can result if medical treatment is not given immediately. Wear face and eye protection, rubber gloves and protective clothing when working near batteries.

▲ CAUTION

If acid contacts your eyes, flush immediately with clear water and get medical attention. If acid contacts your skin, wash off immediately with clear water.

■ Height Restriction

▲ IMPORTANT

The height restrictor fitted to the standard MHP13AT, is not the same device as the 10.9m restriction kit, although both of these devices achieve the same result of restricting the maximum height of the platform to 10.9m from the ground.

This is to allow the unit to be operated by unlicensed operators in accordance with [Australian legislation](#).

▲ WARNING

An Australian operator **MUST** hold a WP Certificate of Competency in order to operate the machine at heights in excess of 11m.

■ Height Restriction on MHP13AT

The MHP13AT (in standard mode) is fitted with a restrictor in the upper hydraulic lift cylinder to keep the platform to a maximum height of 10.9m.

■ 10.9 Metre Restriction Kit

Machines that are built for the Australian market may be fitted with a 10.9m restriction kit.

This kit which can be fitted to the MHP14AT is fitted to restrict the maximum height to the platform floor at 10.9 m from the ground.

Note:

See the Options chapter page 6 for details concerning this kit.

■ Safety Decals and Placards

There are a number of safety decals and placards on the MHP14AT / MHP13AT. Their locations and descriptions are shown in this section on the following pages. Take time to study them.

▲ CAUTION

Be sure that all the safety decals and placards on the MHP14AT / MHP13AT are legible.

Clean or replace them if you cannot read the words or see the pictures. Clean with soap & water and a soft cloth. Do not use solvents.

1. Safety

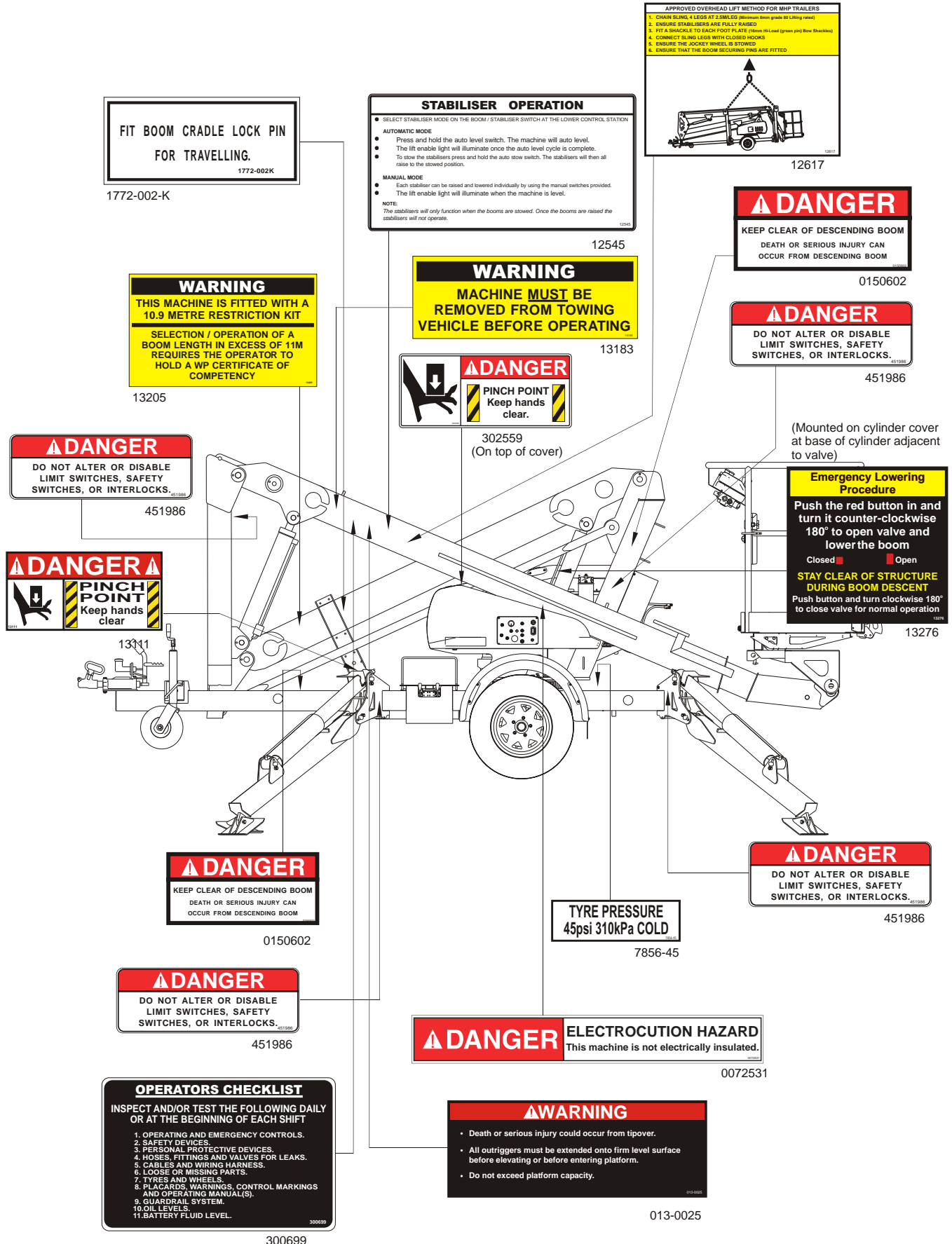

FIT BOOM CRADLE LOCK PIN FOR TRAVELLING.
1772-002K

1772-002-K

STABILISER OPERATION
● SELECT STABILISER MODE ON THE BOOM / STABILISER SWITCH AT THE LOWER CONTROL STATION

AUTOMATIC MODE

- Press and hold the auto level switch. The machine will auto level.
- The lift enable light will illuminate once the auto level cycle is complete.
- To stow the stabilisers press and hold the auto stow switch. The stabilisers will then all raise to the stowed position.

MANUAL MODE

- Each stabiliser can be raised and lowered individually by using the manual switches provided.
- The lift enable light will illuminate when the machine is level.

NOTE:
The stabilisers will only function when the booms are stowed. Once the booms are raised the stabilisers will not operate.

12545

APPROVED OVERHEAD LIFT METHOD FOR MHP TRAILERS

1. CHAIN BUNDS & LEGS AT 2/3RDS (minimum 8mm steel grade 80 lifting rated)
2. ENSURE STABILISERS ARE FULLY RAISED
3. FIT A SHACKLE TO EACH FOOT PLATE (100mm H-Load (green pin) Bow Shackles)
4. CONNECT BUNDS LEGS WITH CLOSED HOOKS
5. ENSURE THE JOCKEY WHEEL IS STOWED
6. ENSURE THAT THE BOOM SECURING PINS ARE FITTED

12617

⚠ DANGER
KEEP CLEAR OF DESCENDING BOOM
DEATH OR SERIOUS INJURY CAN OCCUR FROM DESCENDING BOOM

0150602

WARNING
THIS MACHINE IS FITTED WITH A 10.9 METRE RESTRICTION KIT
SELECTION / OPERATION OF A BOOM LENGTH IN EXCESS OF 11M REQUIRES THE OPERATOR TO HOLD A WP CERTIFICATE OF COMPETENCY

13205

WARNING
MACHINE MUST BE REMOVED FROM TOWING VEHICLE BEFORE OPERATING

13183

⚠ DANGER
PINCH POINT
Keep hands clear.

302559
(On top of cover)

⚠ DANGER
DO NOT ALTER OR DISABLE LIMIT SWITCHES, SAFETY SWITCHES, OR INTERLOCKS.

451986

⚠ DANGER
DO NOT ALTER OR DISABLE LIMIT SWITCHES, SAFETY SWITCHES, OR INTERLOCKS.

451986

⚠ DANGER
PINCH POINT
Keep hands clear.

13311

Emergency Lowering Procedure
Push the red button in and turn it counter-clockwise 180° to open valve and lower the boom
Closed ■ Open ■
STAY CLEAR OF STRUCTURE DURING BOOM DESCENT
Push button and turn clockwise 180° to close valve for normal operation

13275

(Mounted on cylinder cover at base of cylinder adjacent to valve)

⚠ DANGER
KEEP CLEAR OF DESCENDING BOOM
DEATH OR SERIOUS INJURY CAN OCCUR FROM DESCENDING BOOM

0150602

TYRE PRESSURE
45psi 310kPa COLD

7856-45

⚠ DANGER
DO NOT ALTER OR DISABLE LIMIT SWITCHES, SAFETY SWITCHES, OR INTERLOCKS.

451986

⚠ DANGER
DO NOT ALTER OR DISABLE LIMIT SWITCHES, SAFETY SWITCHES, OR INTERLOCKS.

451986

⚠ DANGER ELECTROCUTION HAZARD
This machine is not electrically insulated.

0072531

OPERATORS CHECKLIST
INSPECT AND/OR TEST THE FOLLOWING DAILY OR AT THE BEGINNING OF EACH SHIFT

1. OPERATING AND EMERGENCY CONTROLS.
2. SAFETY DEVICES.
3. PERSONAL PROTECTIVE DEVICES.
4. HOSES, FITTINGS AND VALVES FOR LEAKS.
5. CABLES AND WIRING HARNESS.
6. LOOSE OR MISSING PARTS.
7. TYRES AND WHEELS.
8. PLACARDS, WARNINGS, CONTROL MARKINGS AND OPERATING MANUAL(S).
9. GUARDRAIL SYSTEM.
10. OIL LEVELS.
11. BATTERY FLUID LEVEL.

300699

⚠ WARNING

- Death or serious injury could occur from tipover.
- All outriggers must be extended onto firm level surface before elevating or before entering platform.
- Do not exceed platform capacity.

013-0025

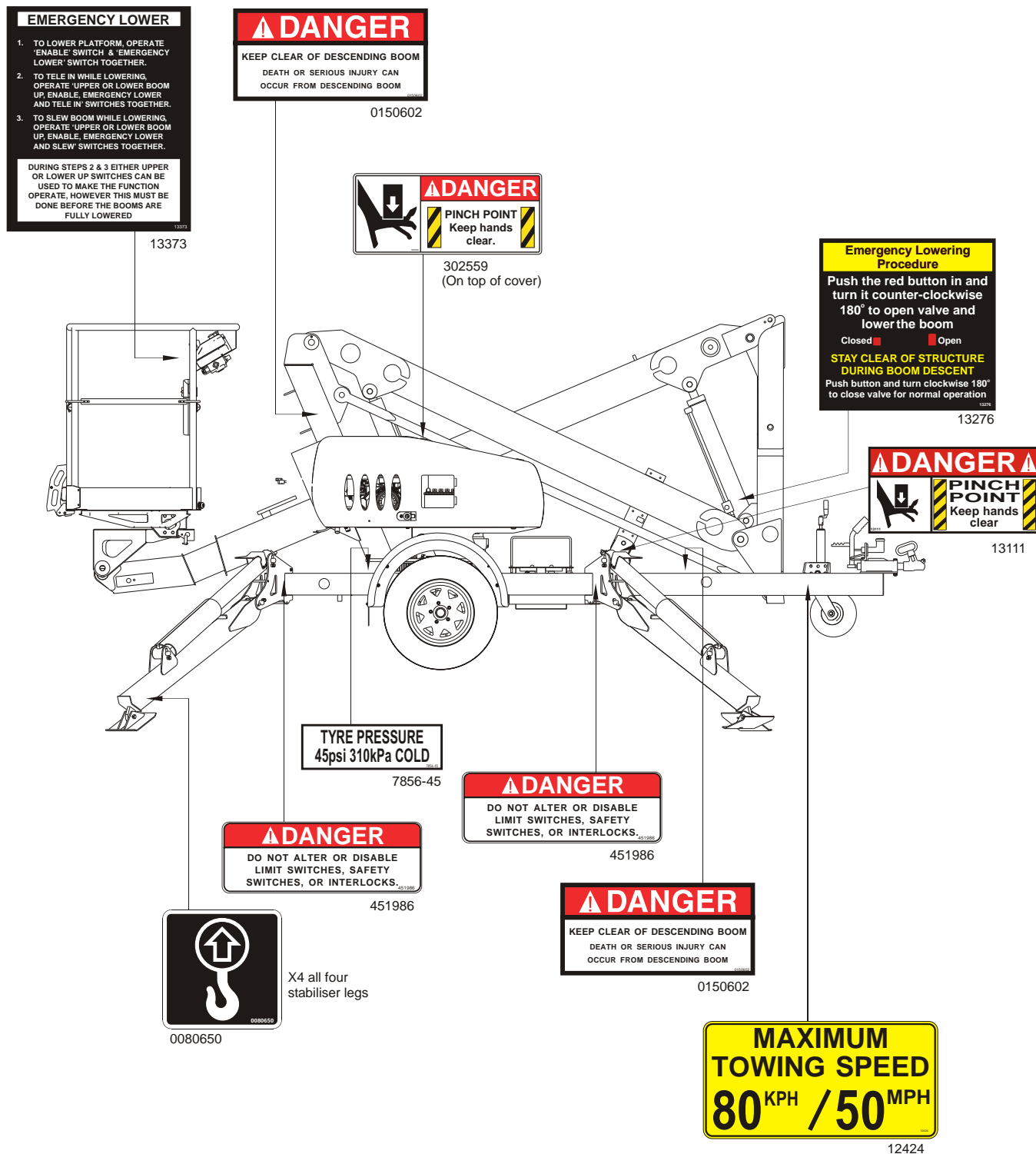

1. Safety

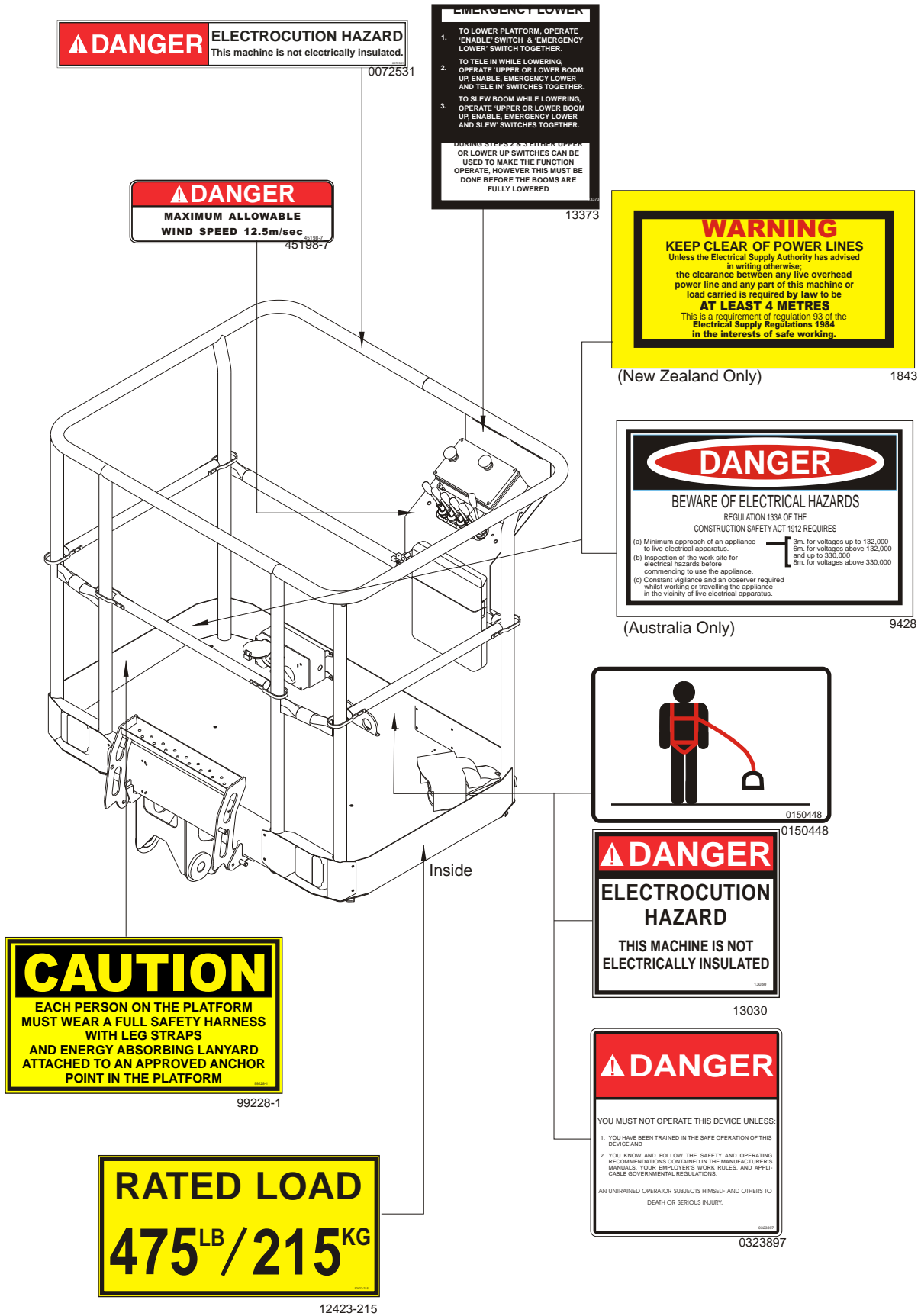

■ Safety Device Information

For emergency operation controls and procedures, see the “Emergency Operation” chapter 9, in this manual.

The devices listed in this chapter are safety devices.

They are on the MHP14AT / MHP13AT to increase safety in the work place for both the operator and other people near the MHP14AT / MHP13AT.

⚠ CAUTION

DO NOT bypass, disable, modify, or ignore any of these devices. Check them carefully at the start of each work shift to see that they are in working order (see “Pre-operational Inspection” chapter 7). If any is found to be defective, remove the MHP14AT / MHP13AT from service immediately until a qualified service technician can make repairs.

■ Emergency Stop Switches

□ At ground control box

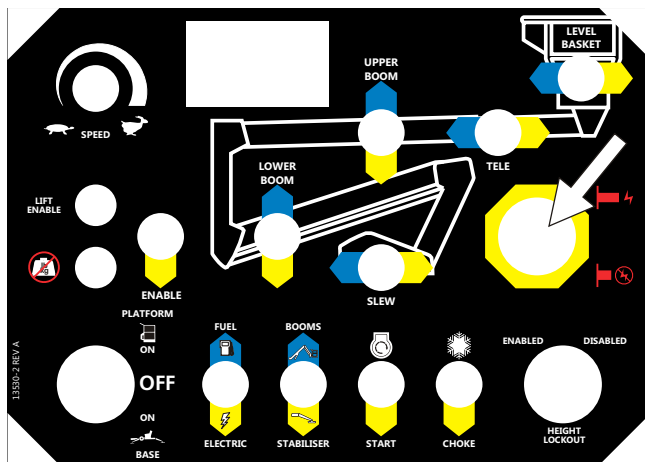

Figure 2.1 - Emergency Stop Switch at Ground Control Box

Press the red **EMERGENCY STOP** button in, at any time, under any conditions, and the entire machine stops, and nothing moves. This switch must be out (on) for anything on the MHP14AT / MHP13AT to work. Pull the switch and it will pop out (on).

□ At platform control box

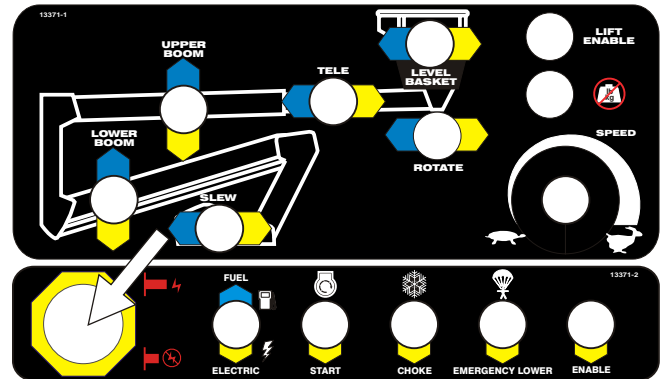

Figure 2.2 - Emergency Stop Switch at Platform Control Box

Press the red **EMERGENCY STOP** button in, at any time, under any conditions, and the entire machine stops, and nothing moves. This switch must be out (on) for anything on the MHP14AT / MHP13AT to work. Pull the switch and it will pop out (on).

NOTE:

*The ground control box is designed to override the platform control box. If the platform control box **EMERGENCY STOP** switch is in (off) the ground control box can still be used to start and operate the MHP14AT / MHP13AT.*

■ Other Safety Devices

□ Lanyard anchor points

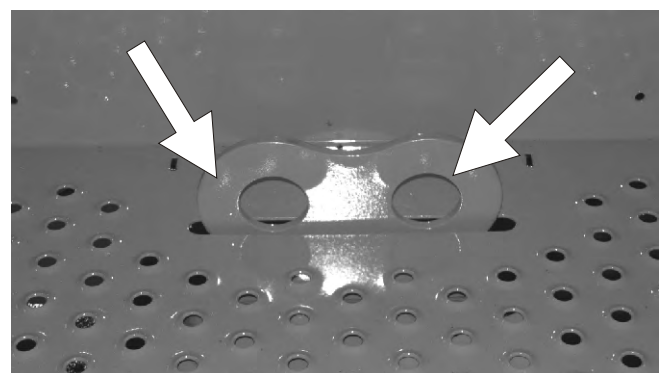

Figure 2.3 - Lanyard Anchor Points

All personnel on the platform should attach their fall restraint lanyards to one of the lanyard anchor points.

The lanyard anchors are located at the rear of the platform floor.

2. Safety Devices

□ Gravity gates



Figure 2.4 - Gravity Gates

The gravity gates are the places in the platform guardrail system where you should enter and leave the platform. Raise the gate where you wish to enter and step under it onto the platform. Once you have entered the platform and attached your fall restraint lanyard to an anchor point, check to see that the gravity gate has fallen back into place.

□ Guardrails



Figure 2.5 - Guardrails

The guardrails help protect you from falling off the platform. Be sure the guardrails are properly installed and that the gravity gate or swinging gate is in place.

□ Height restriction on MHP13AT

The MHP13AT (in standard mode) is fitted with a restrictor in the upper hydraulic lift cylinder to keep the platform to a maximum height of 10.9m.

□ 10.9m height restriction kit (Option)

This kit may be fitted to machines manufactured for the Australian market.

It is fitted to restrict the maximum height to the platform floor to 10.9m from the ground. This is to

allow the unit to be operated by unlicensed operators in accordance with Australian legislation.

Note - Height Restriction Kit

See the Options chapter page 6 for details concerning this kit.

□ Enable switch

The enable switch must be operated in conjunction with the boom/platform moving function you select. The purpose of this switch is to prevent the platform from moving if something or someone accidentally pushes one of the boom/platform moving controls.

There are enable switches fitted to both the Upper and Lower Control Boxes.

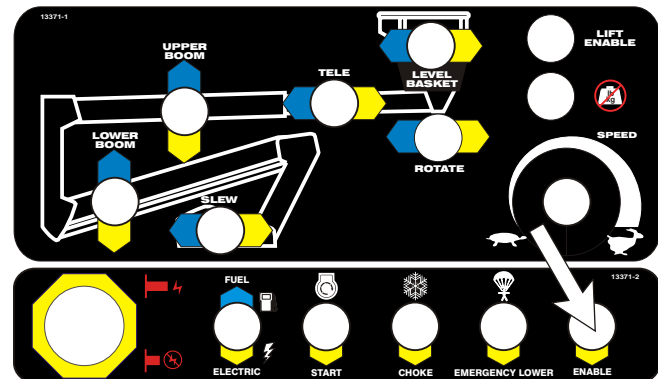

Figure 2.6 - Enable Switch, Platform Control Box

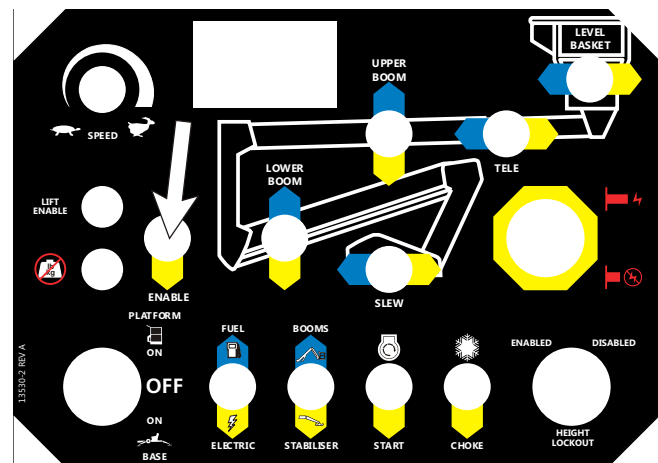

Figure 2.7 - Enable Switch, Ground Control Box

☐ Enable switch (foot) - Optional



Figure 2.8 - Enable Switch (Foot)

The foot switch performs the same function as the standard enable switch described above. Stepping on the foot switch is an action that must be performed, at the same time as another action, to make the booms/platform move.

Note:

If you have the optional 'foot switch' fitted the Enable switches on the Upper Control Box and the Ground Control Box will still function.

■ Platform Overload Protection

The load sensing system sounds an alarm and illuminates a lamp to warn the operator that the platform is overloaded.

The alarm will sound and the overload lights (located at both the Lower and Upper control boxes), will illuminate as soon as the overload point is reached.

Note:

When the alarm sounds all platform movement is prevented.

The alarm and function interlock will remain active until the load is reduced.

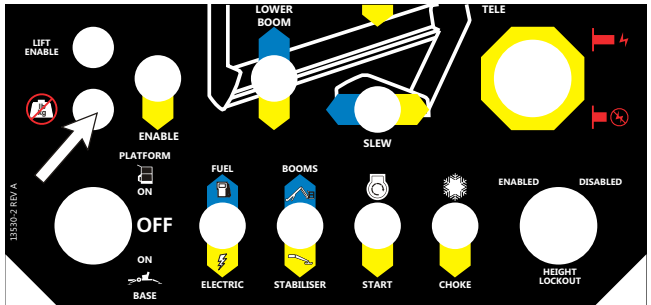

Figure 2.9 - Overload Indicator, Lower Control Box

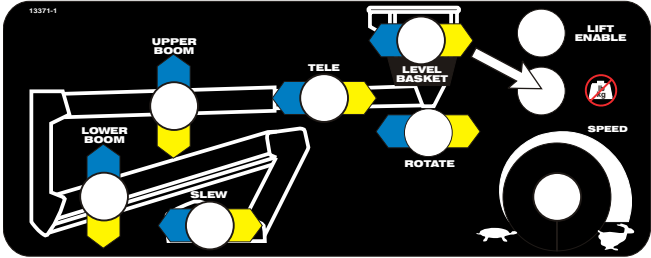

Figure 2.10 - Overload Indicator, Upper Control Box

☐ Bubble level

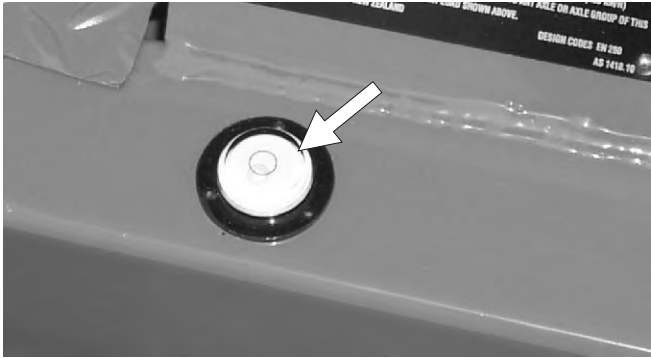

Figure 2.11 - Bubble Level

A bubble level is located on the trailer side rail, beside the outrigger controls. Watch the bubble level while you set the stabilisers. Lower the stabilisers, one at a time, just enough to center the bubble in the circle on top of the gauge. When the bubble is centered the platform is level and can be safely raised.

☐ RCD/ELCB AC outlet (Option)

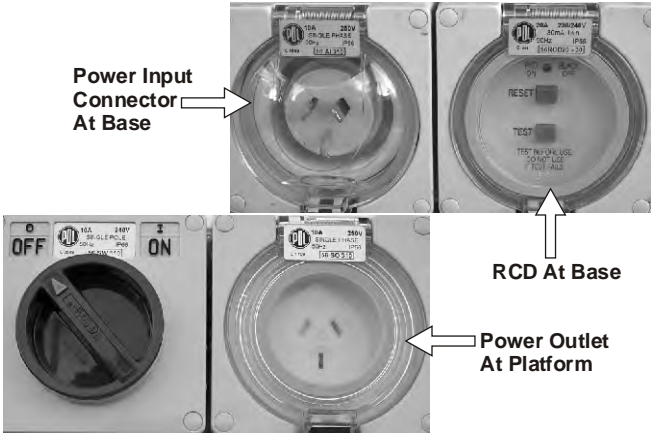

Figure 2.12 - RCD/ELCB AC Outlet, Vertical Mounting

2. Safety Devices

The RCD (Residual Current Device) is located at the base and will protect against short circuits to earth. When there is a short circuit the RCD will shut down the 230v AC power to the platform outlet.

To reset the outlet disconnect the power tool lead from the platform box and reset the RCD at the base. If the problem persists call a trained service technician.

Flashing light (Option)

The flashing light alerts people that the booms / platform of the MHP14AT / MHP13AT are moving. The light flashes at about one flash per second any time the MASTER KEY switch is on. There is no ON/OFF switch for the flashing light, it cannot be turned off while the MHP14AT / MHP13AT is running.

The Snorkel MHP14AT / MHP13AT are boom supported elevating work platforms built to conform to Australian Standard AS1418-10 Elevating Work Platforms.

NOTE:

For further details regarding lubricants, maintenance schedules and service please refer to the Maintenance and Repair Parts Manual for this machine.

■ General Specifications

■ Specifications MHP14AT

SPECIFICATIONS	MHP14AT	
Nominal working height	13.5m	44.3'
Maximum height to basket floor	11.5m	37.7'
Maximum outreach	6.4m	21.0'
Maximum width of base		
Stabilisers retracted	1.6m	5.2'
Stabilisers extended	3.6m	11.8'
Safe working load (unrestricted)	215kg	474lbs
Platform size	1.15 x 0.70m	3.8' x 2.3'
Construction	Steel	Steel
Travelling height	2m	6.6'
Overall length	4.7m	15.4'
Maximum towing speed	80km/h	50mph
Turntable rotation	540° Non continuous	
Trailer tongue weight (approximately)	Less than 100kg	Less than 225lbs
Maximum rated axle capacity	2000kg	4409lbs
Insulation rating	Nil (on standard models)	
Weight	1460kg (Petrol model)	3218lbs (Petrol model)

3. Specifications

■ Specifications MHP13AT

SPECIFICATIONS	MHP13AT	
Nominal working height	12.9m	42.3'
Maximum height to basket floor	10.9m	35.8'
Maximum outreach	6.4m	21.0'
Maximum width of base		
Stabilisers retracted	1.6m	5.2'
Stabilisers extended	3.6m	11.8'
Safe working load (unrestricted)	215kg	474lbs
Platform size	1.15 x 0.70m	3.8' x 2.3'
Construction	Steel	Steel
Travelling height	2m	6.6'
Overall length	4.7m	15.4'
Maximum towing speed	80km/h	50mph
Turntable rotation	540° Non continuous	
Trailer tongue weight (approximately)	Less than 100kg	Less than 225lbs
Maximum rated axle capacity	2000kg	4409lbs
Insulation rating	Nil (on standard models)	
Weight	1460kg (Petrol model)	3218lbs (Petrol model)

□ Recommended Hydraulic Oil

Shell Tellus 32 or Castrol AWS 32 or similar

■ Engine Data

Engine Make	Honda (gasoline)
Model	GX 160
Engine type	4-stroke, over head valve, 1 cylinder
Displacement	163 cm ³ (9.9 cu-in)
Bore x Stroke	68 x 45 mm (2.7 x 1.8 in)
Max. output	4 kW/4,000 rpm
Max. torque	1.1 kg-m (8.0 ft-lb)/ 2500 rpm
Fuel	gasoline
Fuel Grade	automotive gasoline (unleaded or low leaded preferred)
Fuel consumption	230 g/PSh
Cooling system	Forced air
Ignition system	Transistor magneto
PTO shaft rotation	Counterclockwise
Oil Capacity	0.60 litres (0.60 US qt, 0.53 Imp qt)
Oil Grade	SAE 10W-30

3. Specifications

■ Working Envelope - MHP14AT, MHP13AT

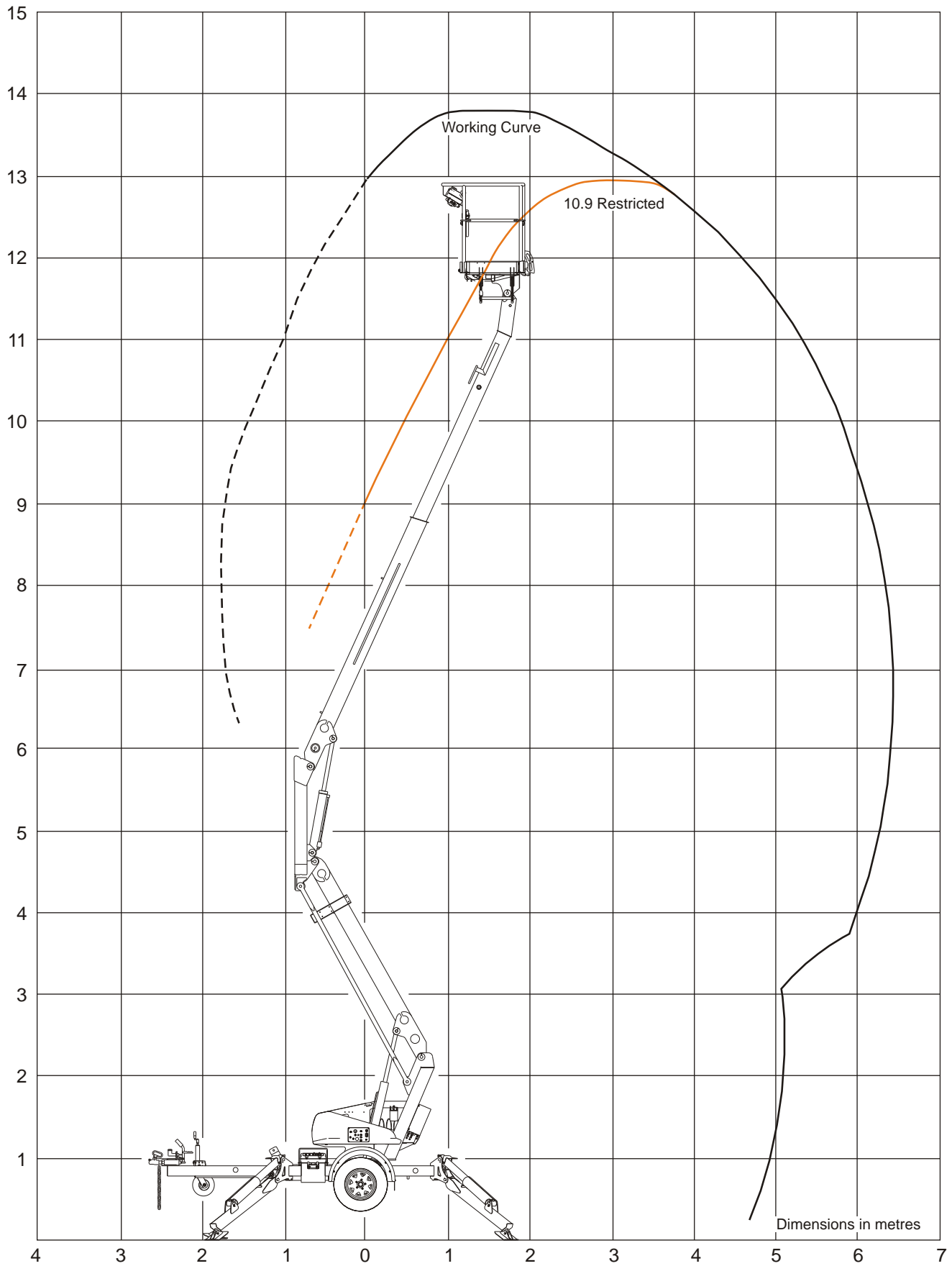

■ Nomenclature

□ Right side view of machine

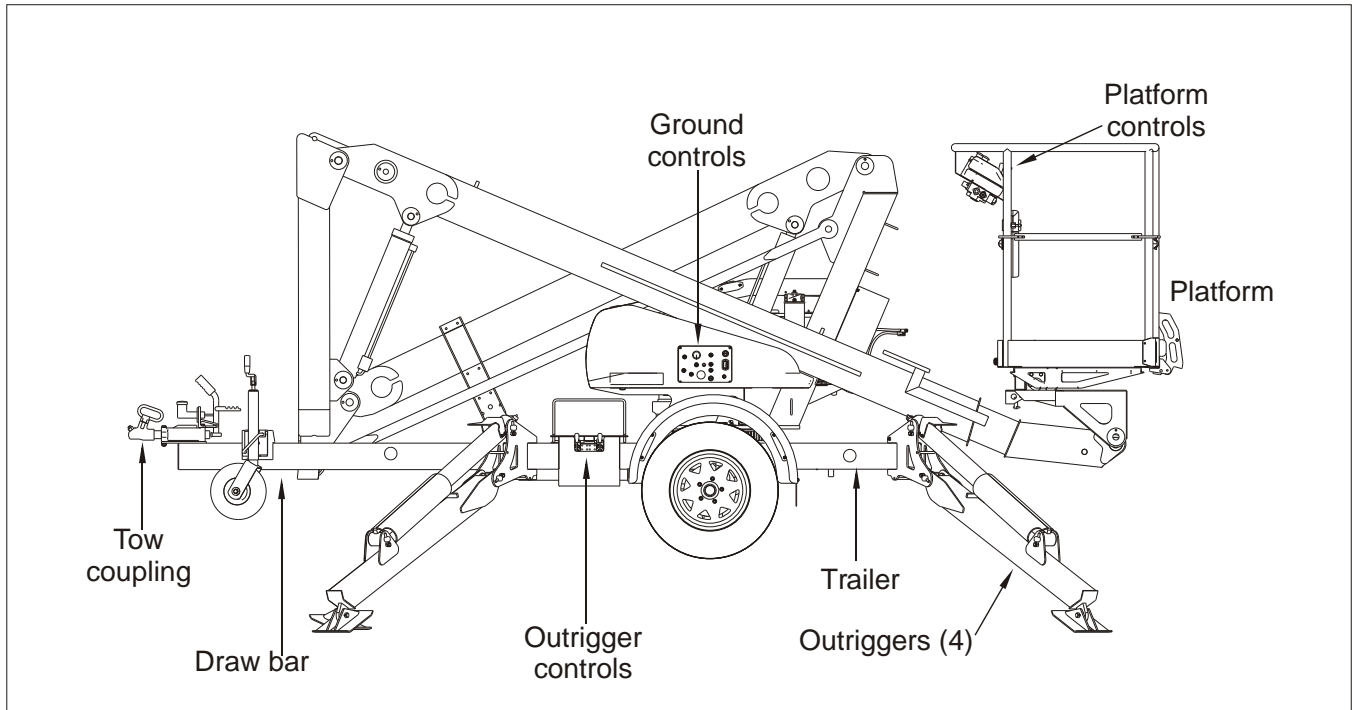

□ Booms identification

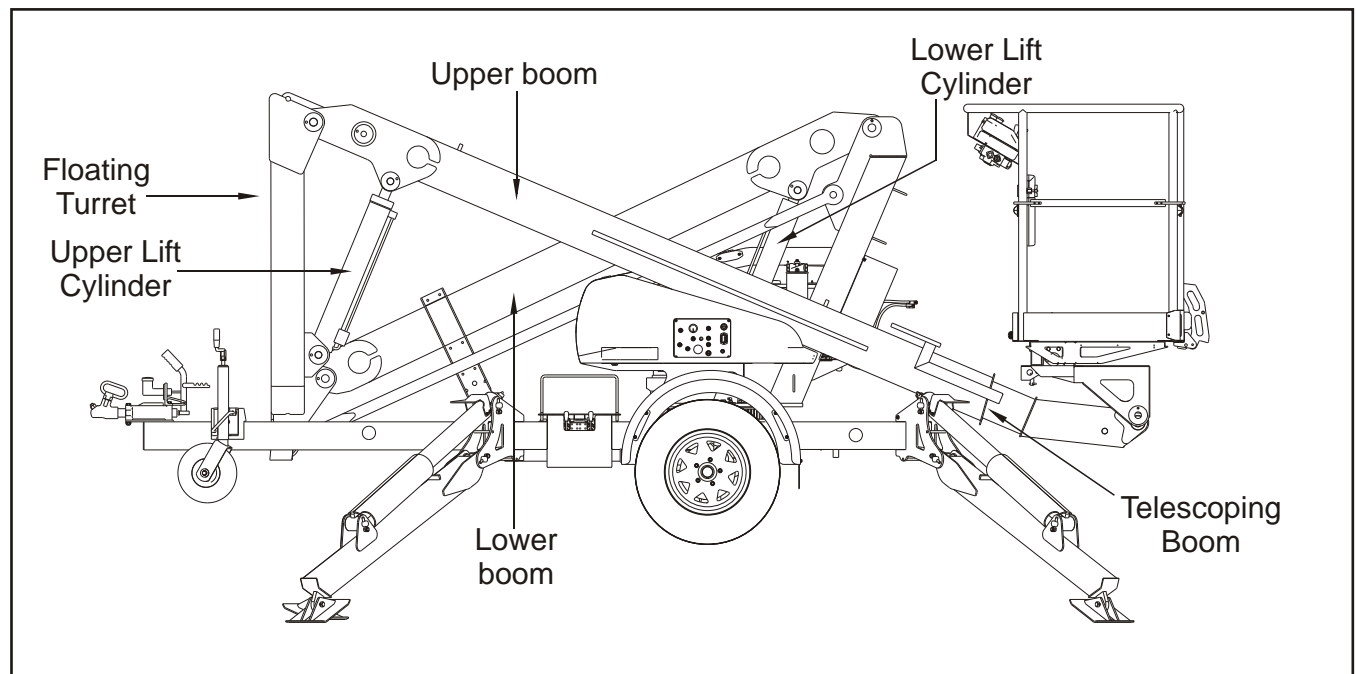

3. Specifications

☐ Left side view of machine

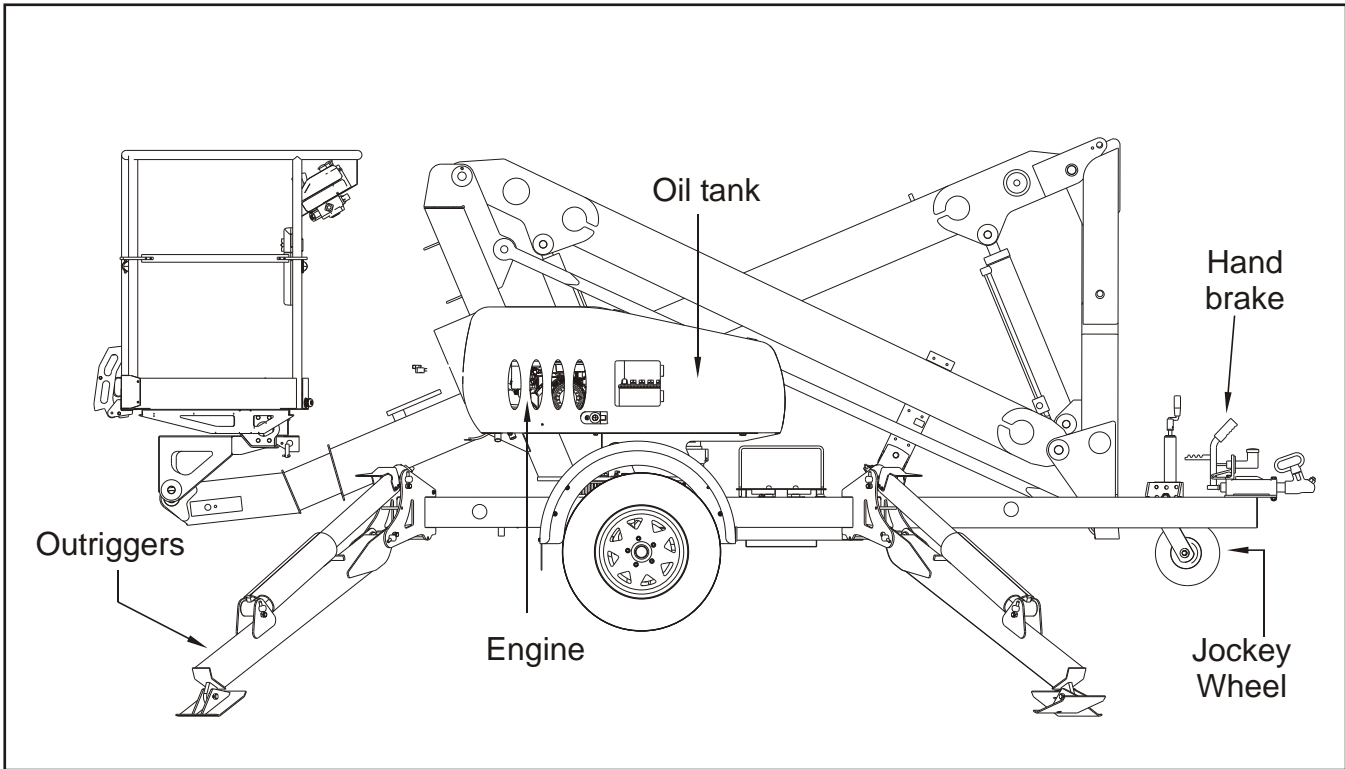

■ Hourmeter



Figure 4.1 - Hourmeter

The hour meter is basically an electric clock. It accumulates time when the master key switch is turned on. The hour meter cannot be reset. An MHP qualified service technician can use it to tell when it is time for the periodic maintenance listed in the maintenance manual.

■ Level Bubble

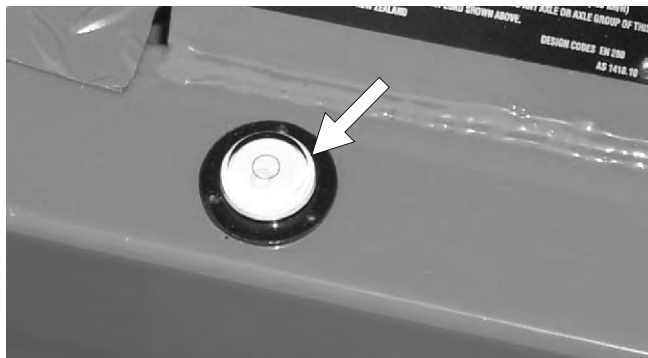

Figure 4.2 - Level Bubble

A level bubble is mounted on the trailer base. Watch the bubble while you set the stabilisers. Lower the stabilisers, front ones first, one at a time just enough to center the bubble in the circle on top of the gauge. When the bubble is central the platform is level and the platform can be safely raised.

■ Hydraulic Oil Level

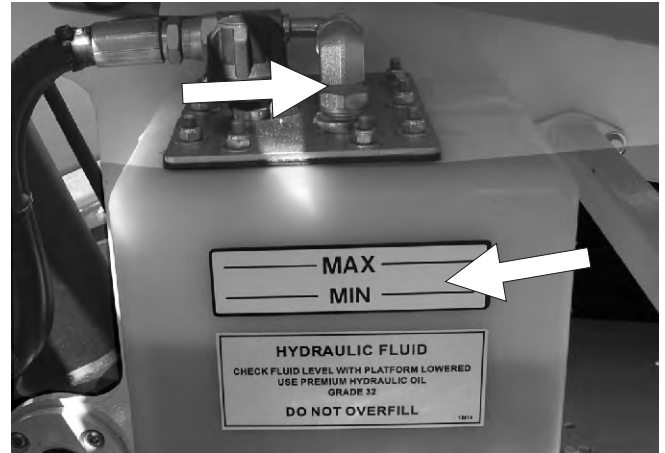

Figure 4.3 - Hydraulic Oil Level

The hydraulic oil level gauge is attached to the side of the hydraulic tank. Read it only when the booms are fully lowered and the stabilisers are raised in the travel position.

The hydraulic oil level should be between the two marks on the decal.

If necessary, add hydraulic oil at the filler cap. see the "Specifications" chapter 3, for type and grade of hydraulic oil.

■ RCD/ELCB Outlet (option)

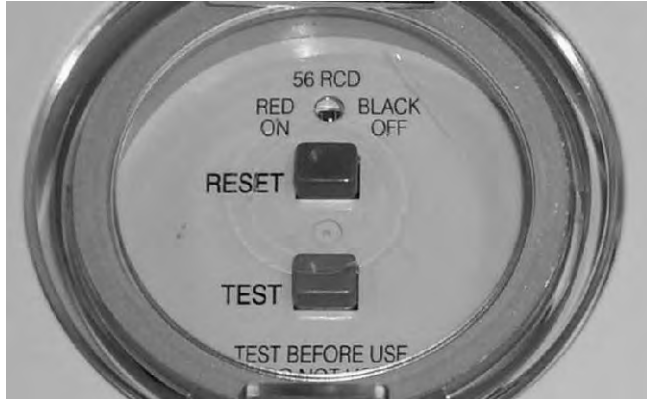

Figure 5.1 - RED/ELCB Outlet

The RCD (Residual Current Device) is located at the base and will protect against short circuits to earth. When there is a short circuit the RCD will shut down the 230v AC power to the platform outlet.

To reset the outlet disconnect the power tool lead from the platform box and reset the RCD at the base.

If the problem persists call a trained service technician.

■ Stabilisers



Figure 5.2 - Stabilisers

The MHP14AT / MHP13AT booms cannot be raised unless the stabilisers are set and the lift enable light on the lower control box is lit. Once the booms are raised from the stowed position the stabilisers become disabled until the booms are stowed in the travel position.

■ Electrical Circuit Protection

There is only one fuse, on a standard MHP14AT / MHP13AT, that is accessible to the operator. Its purpose is to protect the electrical circuits from electrical overloads. When the fuse blows replace it with an identically rated fuse. If the fuse blows a second time, take the MHP14AT / MHP13AT out of service and refer the problem to a qualified trained service technician for repair.

■ Controls Description

This chapter explains what each control does.

This chapter **DOES NOT** explain how to use the controls to produce useful work, refer to the “Operation” chapter 8 for that after you have read this chapter.

For optional equipment controls, see the “Options” chapter.11

See the “Emergency Operation” chapter 9-1 for the location of the emergency bleed down control and for correct emergency bleed down procedures.

The main operating functions of an MHP14AT / MHP13AT can be controlled from the ground control box or from the platform control box.

□ Controls and Control Decal Locations

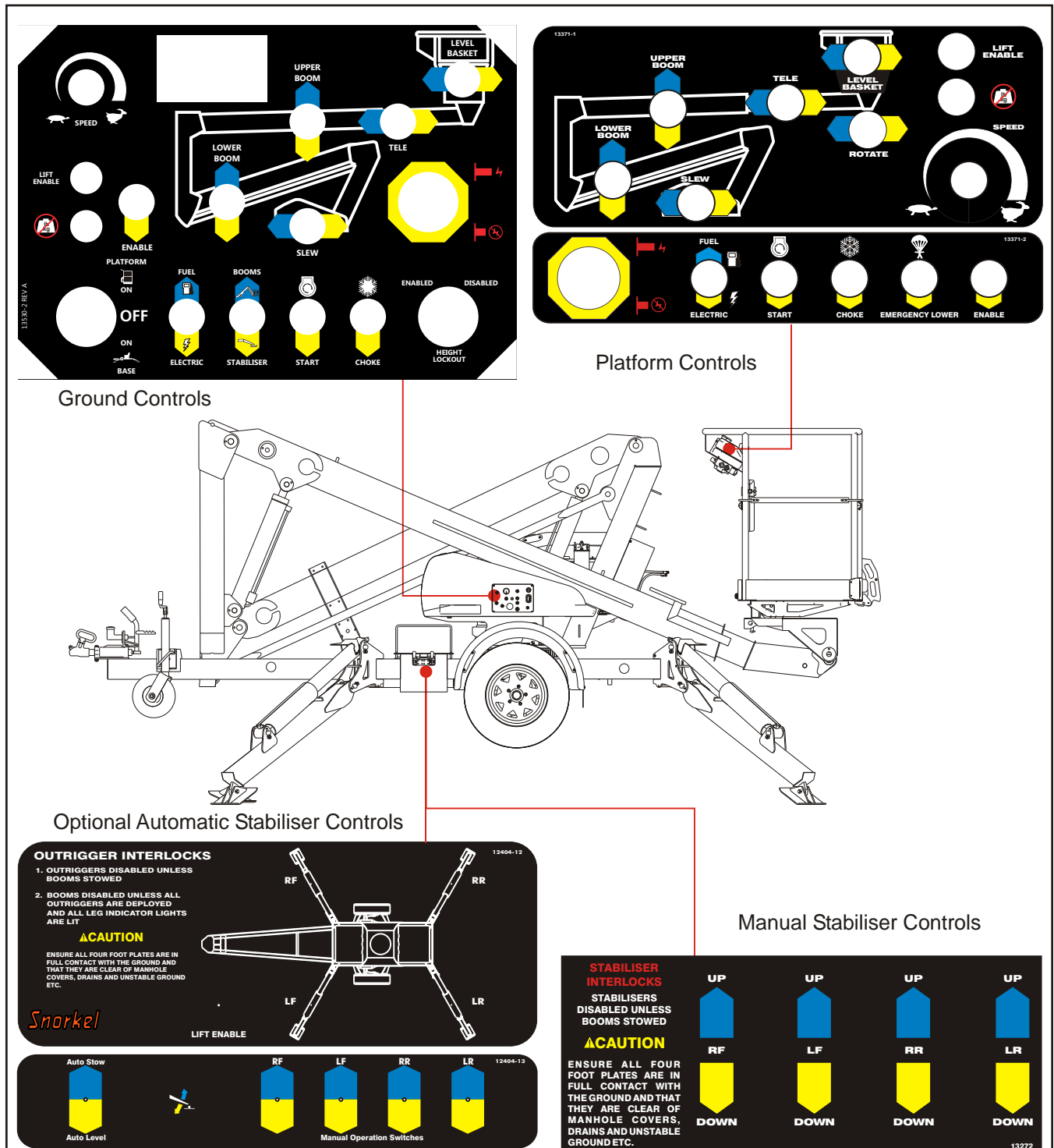

6. Controls

■ Ground Control Box

Controls for operating the MHP14AT / MHP13AT from the ground controls are located on the right side of the column.

□ Lower controls / indicators:

- Emergency stop switch
- Platform / base selector switch
- Choke
- Master key switch
- Boom speed rheostat
- Stabiliser / boom selector switch
- Lower boom switch
- Upper boom switch
- Tele boom switch
- Level basket switch
- Slew switch
- Enable switch
- Lift enable indicator
- 10.9m height lockout switch (Option)
- Fuel / electric selector switch (Option)
- Overload protection indicator
- Emergency lower valve

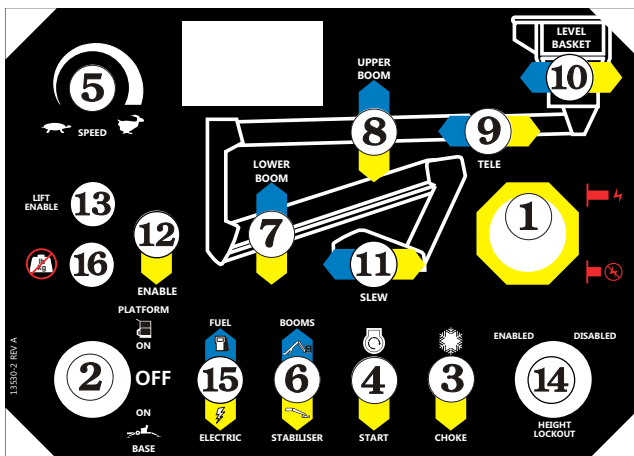

Figure 6.2 - Lower Control Box Controls

1. **Emergency Stop:** Press the red EMERGENCY STOP button in, at any time, under any conditions, and the entire machine stops, and nothing moves. This switch must be out (on) for anything on the MHP to work. Pull the switch and it will pop out (on).

2. **Platform/Base Selector :** Must be in the BASE position for the ground control box to work. The switch MUST be in the PLATFORM position for the platform control box to work.
NOTE: This switch also acts as the 'master key switch'. Turning the key to the central position and removing the key will effectively disable all operations.
3. **Choke/Cold Start:** Hold the switch DOWN while you start an engine that is at ambient air temperature (a "cold" engine). This will choke the engine.
4. **Start Switch:** Press and hold this switch DOWN to operate the starter motor for the MHPAT.
5. **Boom Speed:** This control determines how fast the booms move. Set it to SLOW (turtle) until you are very familiar with the way the machine works or if the platform is working in dangerous or cramped surroundings.
6. **Stabiliser / Boom Selector Switch:** Must be in Stabiliser position (DOWN) for the stabilisers to work. Once the stabilisers are down and set the switch must be placed in the boom (UP) position for the booms to work.

Control switches 7 through 11 are the platform moving switches. Each is a three position, momentary contact, normally OFF switch.

7. **Lower Boom :** UP raises the lower boom. DOWN lowers the lower boom.
8. **Upper Boom:** UP raises the upper boom. DOWN lowers the upper boom.
9. **Tele Boom:** LEFT retracts the telescoping boom. RIGHT extends the telescoping boom.
10. **Level Basket:** LEFT tilts the basket forwards. RIGHT tilts the basket backwards
11. **Slew:** LEFT rotates the entire turntable and boom to the left. RIGHT rotates the entire turntable and boom to the right.
12. **Enable Switch:** The enable switch must be pressed DOWN in conjunction with the boom/platform moving function you select. The purpose of this switch is to prevent the platform/booms from moving if something or someone accidentally pushes one of the boom/platform moving controls. The boom/platform moving switches will not operate unless the enable switch is held down at the same time.

- 13. **Lift Enable Indicator:** The platform can only be raised when this light is lit. When this light is not lit the platform will not raise because the stabilisers are not properly set.
- 14. **Height Lockout Switch (Option):** This switch (when fitted) limits the maximum height of the boom to 10.9 metres (see Options Chapter page 6)
- 15. **Fuel / Electric Selector Switch (Option):** This switch (when fitted) allows switching between different motive sources (see Options Chapter)
- 16. **Overload Indicator:** This indicator illuminates when the platform is overloaded. (see Safety Devices Chapter page 3)
- 17. **Emergency Lower Controls:** Allows the platform to be lowered in the event of an emergency (see Chapter 9 "Emergency Operation") for details of emergency lowering procedures.



Figure 6.3 - Ground Controls, Emergency Bleed Down Control Valve, Lower Boom



Figure 6.4 - Ground Controls, Emergency Bleed Down Control Valve, Upper Boom

■ Platform Control Box

Controls for operating the MHP14AT / MHP13AT from the platform (upper controls) are located on the platform control box, with the exception of the foot switch (option) which is on the platform floor and the manual basket rotator which is mounted on the front of the basket.

□ Upper controls / indicators:

- Emergency stop switch
- Choke
- Start switch
- Boom speed rheostat
- Emergency lower switch
- Lower boom switch
- Upper boom switch
- Tele boom switch
- Level basket switch
- Slew switch
- Enable switch
- Enable foot switch (option)
- Lift enable indicator
- Fuel / electric selector switch (option)
- Overload indicator
- Rotate switch (option)

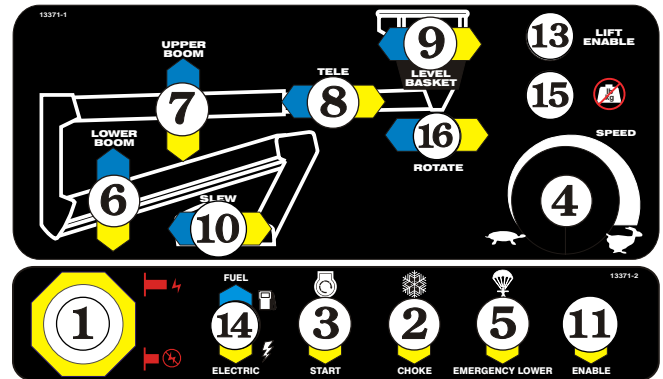

Figure 6.5 - Upper Control Box Controls

1. **Emergency Stop:** Press the red EMERGENCY STOP button in, at any time, under any conditions, and the entire machine stops, and nothing moves. This switch must be out (on) to start or run the MHP from the platform control box. Pull the switch and it will pop out (on). Press the switch in (off) if the platform is to stay in one position for a long time. That will turn the engine off and and save fuel.

6. Controls

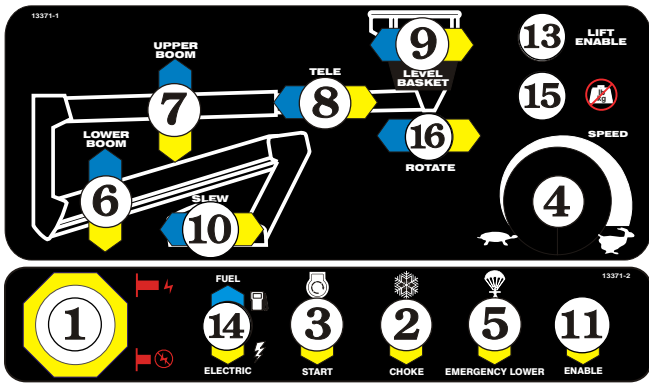

Figure 6.5 - Upper Control Box Controls

- Choke/Cold Start:** Hold the switch DOWN while you start an engine that is at ambient air temperature (a "cold" engine). This will choke the engine.
- Start:** Press and hold this switch DOWN to operate the starter motor for the MHPAT.
- Boom Speed:** This control determines how fast the booms move. Set it to SLOW (turtle) until you are very familiar with the way the machine works or if the platform is working in dangerous or cramped surroundings.
- Emergency Lower Controls:** If the engine stops and cannot be restarted, or some other emergency prevents the platform being lowered in the normal way, operate the EMERGENCY LOWER switch and the ENABLE switch together and this will cause the upper and lower booms to descend. To slew during the emergency lower operate the EMERGENCY LOWER, ENABLE, UPPER or LOWER BOOM UP, and SLEW switches together. To tele in during the emergency lower operate the EMERGENCY LOWER, ENABLE, UPPER or LOWER BOOM UP, and TELE switches together.

See Chapter 9 "Emergency Operation" for details of emergency lowering procedures from the platform.

Items 6 through 10 are the platform moving switches. Each is a three position, momentary contact, normally OFF switch.

- Lower Boom:** UP raises the lower boom. DOWN lowers the lower boom.
- Upper Boom:** UP raises the upper boom. DOWN lowers the upper boom.
- Tele Boom:** LEFT retracts the telescoping boom. RIGHT extends the telescoping boom.

- Level basket:** LEFT tilts the basket forwards, RIGHT tilts the basket backwards.
- Slew:** LEFT rotates the entire turntable and boom to the left. RIGHT rotates the entire turntable and boom to the right.
- Enable:** The enable switch must be pressed DOWN in conjunction with the boom/platform moving function you select. The purpose of this switch is to prevent the platform/booms from moving if something or someone accidentally pushes one of the boom/platform moving controls. The boom/platform moving switches will not operate unless the enable switch is held down at the same time.
- Enable Foot Switch (Option):** The foot switch performs the same function as the standard enable switch described above. Stepping on the foot switch is an action that must be performed, at the same time as one of the boom/platform moving switches is operated.



Figure 6.6 - Upper Controls - Foot Switch

Note:

If you have the optional 'foot switch' fitted this is an "and" option and the Enable switches on the Lower & Upper Control Boxes will still function.

- Lift Enable Indicator:** The platform can only be raised when this light is lit. When this light is not lit the platform will not raise because the outriggers are not properly set.
- Fuel / Electric Selector Switch (Option):** This switch (when fitted) allows switching between different motive sources (see Options Chapter).
- Overload Indicator:** This indicator illuminates when the platform is overloaded (see Safety Devices Chapter page 3).

- Rotator Switch (Option):** LEFT rotates the platform to the left. RIGHT rotates the platform to the right.

■ **Stabiliser Controls (Manual)**



Figure 6.7 - Stabiliser Controls (Manual)

- Boom / Stabiliser Switch:** Ensure the boom/stabiliser switch on the lower control box is set to stabiliser (see Item 6 on page 2 of this chapter)



Figure 6.8 - Decal Stabiliser Controls (Manual)

NOTE:

Ensure that the front stabilisers are lowered first to prevent damage to the jockey wheel.



Figure 6.9 - Stabiliser Controls (Manual)

- Valve Levers:** Operate the valve levers to activate the stabilisers and level the machine.
- Bubble level:** Use the bubble level to level the machine.

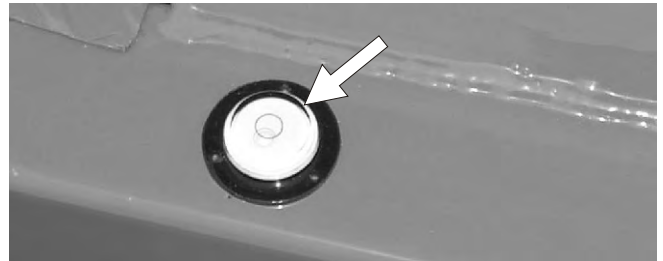

Figure 6.10 - Bubble Level

■ **Self Levelling Stabilisers (Option)**



Figure 6.11 - Self Levelling Stabiliser Controls

- Auto Level / Stow Switch:** Select either auto level or auto stow, to raise or lower the stabilisers automatically.
- Manual Stabiliser Switches:** Operate the manual switches to manually raise or lower individual stabilisers.
- Leg Indicator Lights:** Illuminate when the legs are in contact with the ground.
- Lift Enable Light:** This is a duplicate of the lift enable light on the lower control box. The platform can only be raised when this light is lit. When this light is not lit the platform will not raise because the stabilisers are not set properly.

NOTE:

Ensure that the front stabilisers are lowered first to prevent damage to the jockey wheel.

6. Controls

Activate the rear stabilisers and level the machine using the level bubble adjacent to the control levers.

▲ IMPORTANT

Information on controls for non-standard features (options) are shown in the Options chapter.

▲ WARNING

Pinch points may exist between moving components. death or serious injury can result from becoming trapped between components, buildings, structures, or other obstacles. make sure all personnel stand clear while operating the MHP.

7. Pre-operational Inspection

At the start of each work day (or 8 hour shift), an MHP14AT / MHP13AT qualified operator must perform the Pre-operational Inspection as listed in the table below.

The purpose of the Pre-operational Inspection is to keep the MHP14AT / MHP13AT in proper working condition and to detect signs of malfunction at the earliest possible time.

The MHP14AT / MHP13AT should be in the STOWED POSITION and the **Master Key Switch** set to OFF before you begin this inspection.

Defective parts and/or equipment malfunctions jeopardize the safety of the operator and other personnel, and can cause damage to the machine.

▲ DANGER

DO NOT operate an MHP14AT / MHP13AT that is known to be damaged or malfunctioning.

Repair all equipment damage or malfunctions, before placing the MHP14AT / MHP13AT into service.

■ Pre-operational Inspection Table

Item	Service Required
Engine fuel level	Look to see that the fuel tank is full
Fuel tank cap	Check to see that the cap is tight
Engine oil level	Check oil level (between dipstick lines)
Fuel leaks	Visually inspect (hoses and connections)
Engine cooling	Check that grills are not blocked
Wiring harnesses	Visually inspect (installation, condition)
Battery terminals	Visually inspect (no corrosion)
Battery fluid level	Check fluid level (1/4" or 6 mm below filler neck)
Hydraulic oil level	Visually inspect level (between lines on decal)
Hydraulic oil leaks	Visually inspect (hoses, tubes)
Tires and wheels	Visually inspect (condition)
Tire pressure	Check pressure (measure)
Bolts and fasteners	Visually inspect (condition)
Structural damage and welds	Visually inspect (weld cracks, dents)
Lanyard anchor points	Visually inspect (condition)
Platform gravity gate	Check condition and operation
Platform guardrails	Visually inspect (condition)
Flashing light (option)	Visually inspect (operation)
Ground control switches	Actuate and inspect for proper operation
Ground control valve levers	Check operation (causes correct motion)
Ground emergency lower	Check operation (causes correct motion)
Emergency lower	Check operation (causes correct motion)
Platform control box switches	Actuate and inspect for proper operation
Platform emergency lower	Check operation (causes correct motion)
RCD/ELCB AC outlet (option)	Check operation
Platform work lights (option)	Check operation
Placards and decals	Visually inspect (installation, condition)
Platform entry ladder	Visually inspect (condition)

7. Pre-operational Inspection

The rest of this chapter shows how to perform the inspection and maintenance required for each item in the Pre-operational Inspection Table.

■ Engine Fuel Level

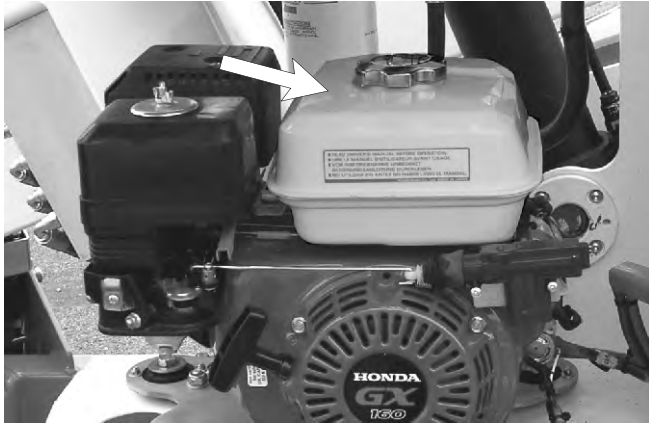

Figure 7.1 - Engine Fuel Level

Visually check to see that the gasoline tank is full. See the “Specifications” chapter 3, fuel for octane and grade.

■ Fuel Tank Cap



Figure 7.2 - Engine Fuel Tank Cap

Check to see that the tank cap is in place and is tight.

■ Fuel Leaks

Visually inspect the Honda fuel tank and the entire length of the fuel line, from the engine to the fuel tank, for leaks.

■ Engine Oil Level

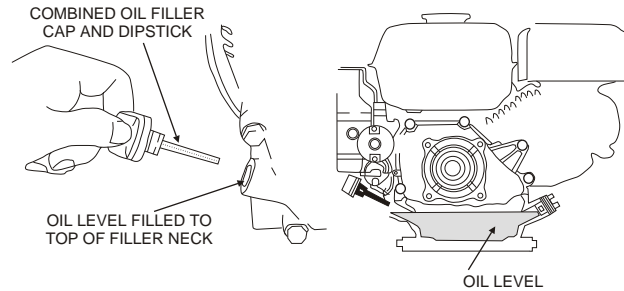

Figure 7.3 - Engine Oil Level

Remove the oil filler cap and wipe the dipstick clean. Insert the dipstick into the oil filler neck, but do not screw it in.

If the level is low, fill to the top of the oil filler neck with the recommended oil.

See the “Specifications” chapter 3, for the correct engine oil grade and weight.

■ Operator's Manual



Figure 7.4 - Operator Manual

Check that the Operator's manual is complete and in the holder on the platform.

■ Wiring Harnesses

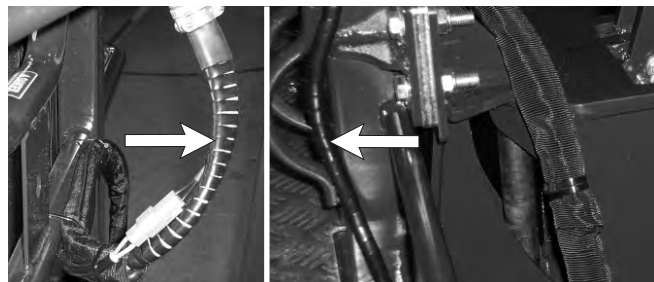

Figure 7.5 - Wiring Harnesses

Inspect all the wiring harnesses, on the machine, for loose connections, broken wires, and frayed insulation.

■ Battery Terminals

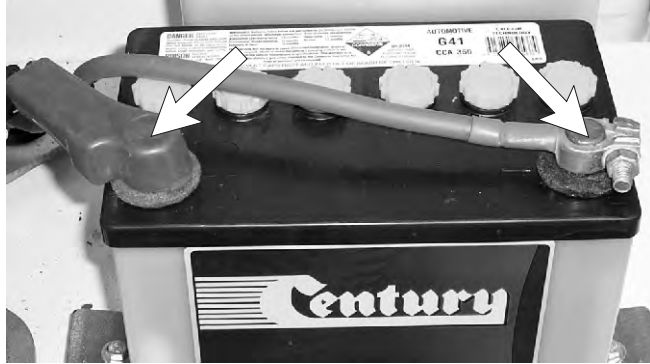

Figure 7.6 - Battery Terminals

Battery terminals should be tight, clean and free of dirt and corrosion.

■ Battery Fluid Level

▲ DANGER

Batteries emit hydrogen and oxygen, elements that can combine explosively.

DO NOT smoke or permit open flames or sparks when checking batteries.

When working around batteries, **ALWAYS** wear a face shield to avoid acid in the eyes. If acid contacts eyes, flush immediately with clear water and get medical attention.



Figure 7.7 - Battery Fluid Level

Remove the caps from the battery and visually check to see that the battery fluid is 1/4" (6 mm) below the bottom of the filler neck inside each hole.

■ Hydraulic Oil Level

To check the hydraulic oil level:

Completely lower the booms and ensure the stabilisers are in the stowed position.



Figure 7.8 - Hydraulic Oil Level

The hydraulic oil level should be between the two marks on the decal.

If necessary, add hydraulic oil at the filler cap (see Figure 7.9). See the "Specifications" chapter 3, for type and grade of hydraulic oil.

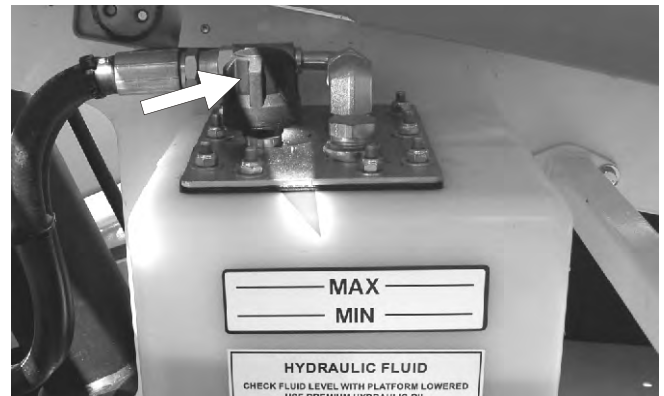

Figure 7.9 - Hydraulic Oil Add

■ Hydraulic Oil Leaks

▲ DANGER

Leaking hydraulic oil can cause burns, fires, falls (slipping), cuts, and puncture wounds (if under high pressure). Do not search for leaks with your hand. Have a qualified trained maintenance person repair all hydraulic fluid leaks before you operate an MHP14AT.

Hydraulic oil leaks are easily visible and can show up anywhere.

Visually inspect the entire machine for hydraulic oil. Check the ground under the machine for leaked oil.

Carefully inspect the ends of the upper and lower booms. Oil can run down inside of the booms and drip out the end.

7. Pre-operational Inspection



Figure 7.10 - Hydraulic Oil Leaks At Fittings And Hoses

Inspect all fittings and hoses for leaks. Inspect hoses for signs of damage from chaffing or rubbing against protrusions on the chassis.

■ Bolts and Fasteners

Visually inspect all fasteners to see that none is missing or obviously loose.

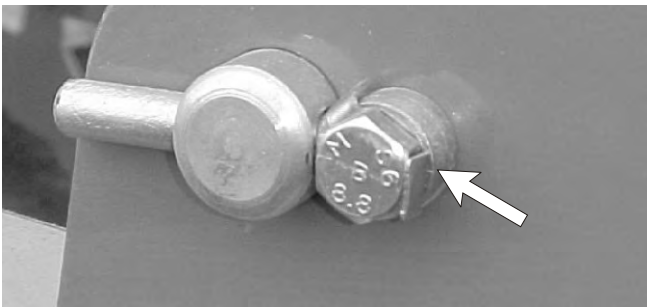

Figure 7.11 - Critical Pin Retainer Bolts

Critical pin retainer bolts have lock tab washers fitted, they should all be present and not damaged in any way.



Figure 7.12 - Wheel Nuts

Pay particular attention to all of the wheel nuts and bolts. None should be visibly loose, missing, or deformed.

Also inspect the wheel rim to ensure that it is not damaged or deformed, especially checking the recess where the wheel nuts are seated.

▲ CAUTION

Do not over tighten the wheel nuts. Over tightened wheel nuts can damage or deform the wheel rim. This can lead to handling and stability problems when towing.

▲ IMPORTANT

The correct torque setting for the MHP14AT / MHP13AT wheel nuts is 50 lb ft or 68 Nm. Do not tighten beyond these settings.

■ Wheels and Tyres

The MHP14AT / MHP13AT relies on it's tyres for towing stability.



Figure 7.13 - Tyre Condition

Check each wheel for obvious damage that could cause a blowout.

□ Tyre Pressure

Ensure tyre pressures are maintained according to the decal attached to the trailer behind the mud-guard adjacent to the mounting bracket.

▲ IMPORTANT

The correct tyre pressure for the MHP14AT / MHP13AT is 45psi or 310kPa (readings taken with cold tyres).

Note - Spare Wheel

If you have this option fitted remember to check the condition and the tyre pressure of the spare wheel.

■ Structural Damage and Welds

Visually inspect all welds for cracks, all structural members for deformity.

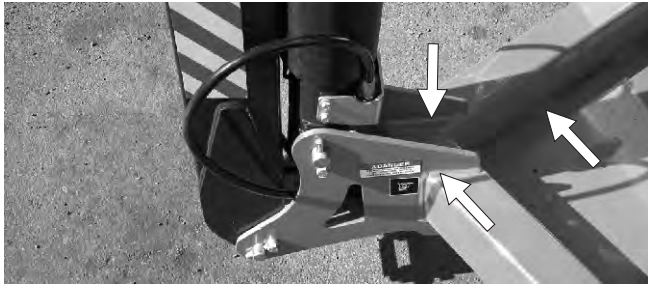
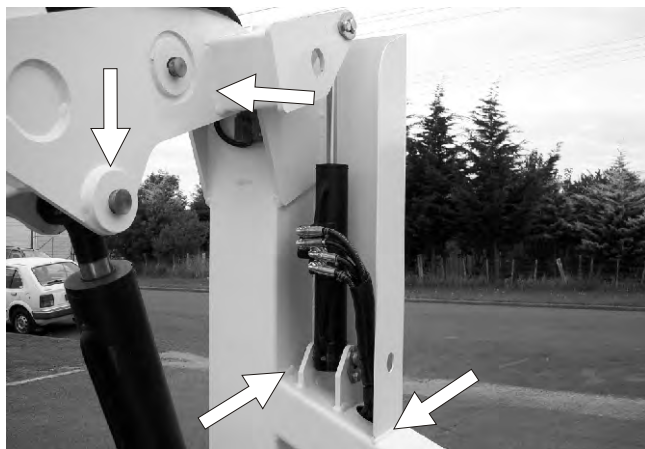

Figure 7.14 - Chassis Welds

Pay particular attention to the chassis welds



Figures 7.15 - Boom Welds

Closely inspect boom welds all the way around, for cracks.

■ Lanyard Anchor Points

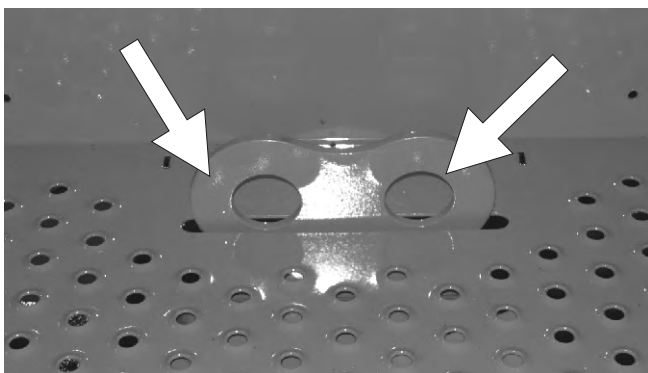

Figure 7.16 - Lanyard Anchor Points

Visually check the lanyard anchor points to see that they are not deformed or cut off and that the securing bolts are tight and undamaged.

■ Platform Gravity Gates



Figure 7.17 - Platform Gravity Gates

Check to see that the three gravity gates are present and function correctly.

■ Platform Guardrails



Figure 7.18 - Platform Guardrails

Visually inspect the platform guardrails to see that none of the tubing has been cut out, removed, or deformed in any way. Visually check the guardrail welds to see that none is cracked nor ground down.

■ Platform Access Step

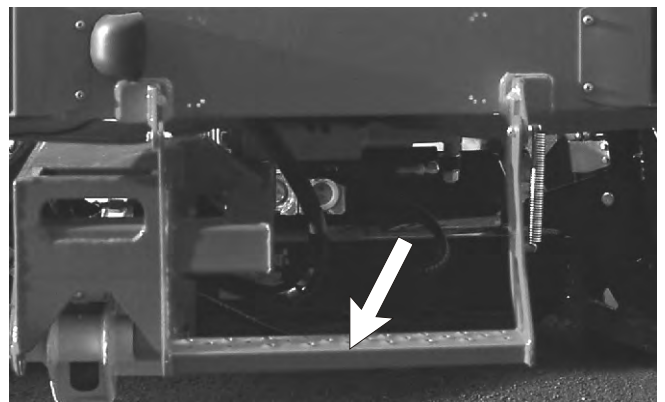

Figure 7.19 - Platform Access Step

7. Pre-operational Inspection

Check to see that the step structure is undamaged and that none of the fixing bolts are missing.

■ Flashing Light (option)

Visually check the optional flashing light, to see that the light flashes at approximately one flash per second when the motor key switch is turned on.

Before proceeding with the next section of the Pre-operational Inspection you will need to **start the engine and set the stabilisers**. Refer to the 'Operation' chapter if you need assistance with this.

■ Ground Control Switches

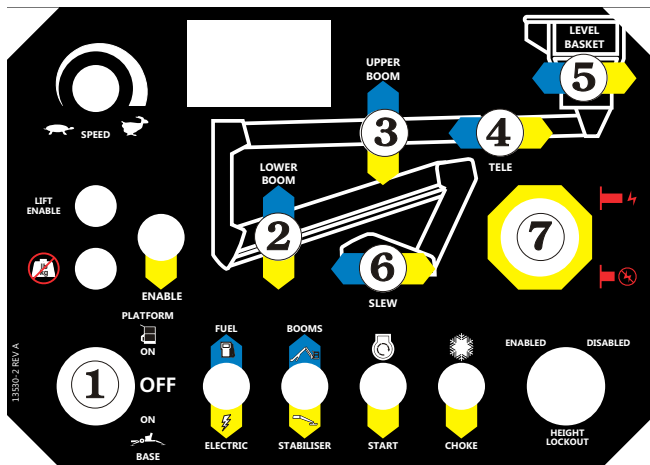

Figure 7.20 - Ground Control Switches

With the Ground/Platform Selector ① set to ground:

Check that each of the platform moving switches (② through to ⑥) cause the MHP14AT / MHP13AT to move the way it should.

Check both positions of each switch.

For correct operating procedures see the "Operation" chapter 8.

NOTE

Pay particular attention to the **Emergency Stop switch ⑦** to see that it turns the MHP14AT / MHP13AT engine off when the red button is struck.

■ Emergency Lower

There are two manual bleed down valves to operate from the ground position. One controls the descent of the lower boom and the other controls the descent of the upper boom. The lower boom must be lowered first.

□ Ground Station

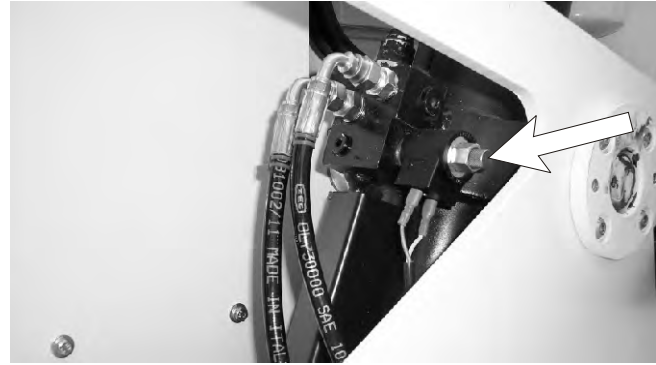

Figure 7.21.1 - Emergency Lower Valve, Controlling Lower Boom

The valves are opened by pushing in the red knob and turning it anti-clockwise 180°.

With the booms raised open the valve on the lower boom (see Figure 7.21.1). The boom should begin to lower.

When the lower boom has fully descended open the valve for the upper boom (see Figure 7.21.2). The boom should begin to lower.

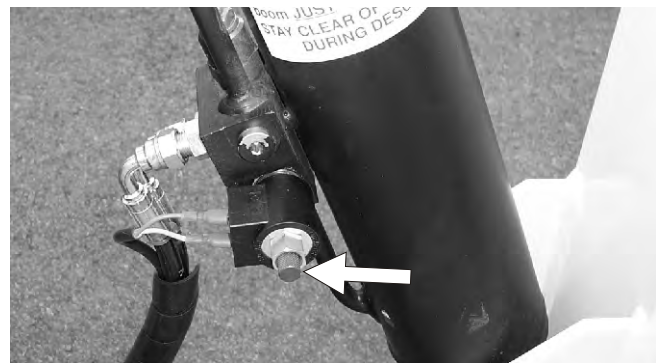

Figure 7.21.2 - Emergency Lower Valve, Controlling Upper Boom.

NOTE

The manual emergency lower valves must be closed after the test to ensure proper boom operation. This is achieved by pushing in the knurled red knob and turning it 180° clockwise.

For full details on emergency lowering operating procedures see "Emergency Operation" chapter 9.

□ Upper control box

Emergency lowering from the upper control box is achieved by operating the **Emergency Lower** switch and the **Enable** switches together.

With the booms raised operate the emergency lower and enable switches. The booms should begin to lower together.

It is possible to slew the unit or to telescope in during the lowering process. For correct emergency lowering operating procedures see “Emergency Operation” chapter 9.

■ Platform Control Switches

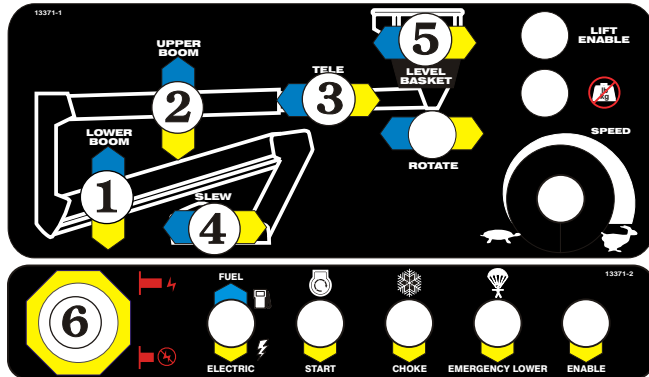

Figure 7.22 - Platform Control Switches

On the ground control box set the **Ground/Platform Selector** to platform.

Check that each of the platform moving switches (1 through to 5) cause the platform to move the way it should.

Check both positions of each switch.

For correct operating procedures see the “Operation” chapter 8.

NOTE

Pay particular attention to the **Emergency Stop** switch 6 to see that it turns the MHP14AT / MHP13AT engine off when struck.

Pay particular attention to the platform Enable switch or the platform foot switch (if that option is fitted) to see that the platform moving switches are deactivated when the either switch is not operated.

At the completion of the above section the unit can be returned to the stowed position.

■ AC Outlet RCD/ELCB (option)

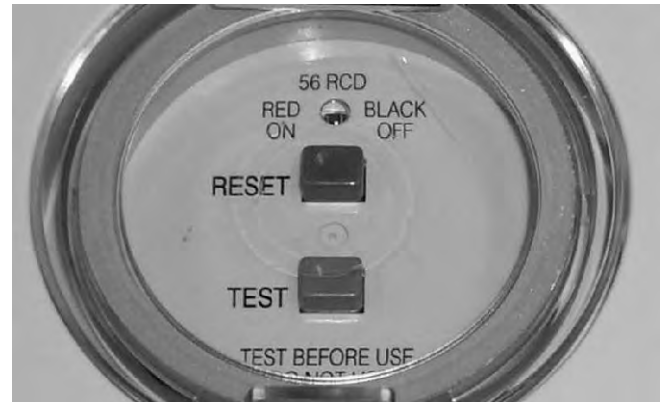

Figure 7.23 - AC Outlet RCD/ELCB

If the MHP14AT / MHP13AT has this option fitted check the RCD works by connecting a power source to the base inlet and an appliance to the platform outlet.

Push the test button on the RCD/ELCB device and the power outlet at the platform should not work.

▲ CAUTION

RCD/ELCB devices should only be replaced by a qualified electrician.

■ Placards and Decals

Look to see that all placards and decals are in place and legible. Clean dirty or obscured decals with soap and water and a soft lint cloth. Replace any missing or illegible placards or decals before placing the MHP14AT / MHP13AT into service for the daily work shift.

NOTE:

Owing to manufacturing variances and customer preferences there may be some small differences in the decal layout on specific machines.

NOTE Safety Decals:

Details of the safety decals and their locations are listed in the Safety chapter(s) near the beginning of this manual.

■ Placards and Decals

Replacement decals and placards for the MHP14AT / MHP13AT are available from Snorkel dealers.

Standard placards and decals

See pages 7 - 8 and 7 - 9 for the decal list and locations of individual decals.

7. Pre-operational Inspection

□ Decal list

No	Part No	Description	Req
1	511067-000	Decal - Snorkellift.com logo	2
2	0150448	Decal - Lanyard attachment	1
3	0072531	Decal - Electrocutation hazard	1
4	12814	Decal - Hydraulic fluid	1
5	12833-2	Serial number plate	1
6	13471-04	Decal - MHP14AT logo	2
	13471-03	Decal - MHP13AT logo	2
7	1843	Decal - Warning, New Zealand only	1
	9428	Decal - Electric hazard, Australia only	1
8	300699	Decal - Operators checklist	1
9	45198-6	Decal - Do not disable limit switch	6
10	45198-7	Decal - Wind speed rating	2
11	302559	Danger pinch point	2
12	12424	Decal - Towing speed	1
13	7856-45	Decal - Tyre pressure	2
14	0083426	Decal - Lifting & tie down	4
15	9223-3	Chevron warning stripes (pieces)	8
16	013-0025	Decal - Warning with stabilisers	1
17	9751	Decal - New Zealand made logo	1
18	12545	Decal - Auto stabiliser operation	1
19	13111	Danger pinch point (small)	2
20	1772-002-K	Decal - Fit boom cradle lock pin	1
21	13276	Decal - Emergency bleed down valve	2
22	007-1925	Decal - Gasoline	1
23	0323897	Decal - Danger must not operate	1
24	12423-215	Decal - Rated load	1
25	99228-1	Decal - Caution safety harness	1
26	015-0602	Decal - Danger keep clear of descending boom	4
27	56242-6	Decal - Operator manual enclosed	1

No	Part No	Description	Req
28	13205	Decal - 10.9m height restriction	1
29	13183	Decal - Remove from towing vehicle before operating	1
30	302950	Hydraulic oil level	1
31	13272	Decal- Manual stabilisers only	1
32	12617	Decal - Approved lift method	1
33	0080650	Decal - Shackle foot point	4
34	13373	Decal - Emergency lowering	1
35	0072531	Decal - Electrocutation hazard	1
36	13030	Decal - Electrocutation hazard	1

7. Pre-operational Inspection

Decal inspection drawing

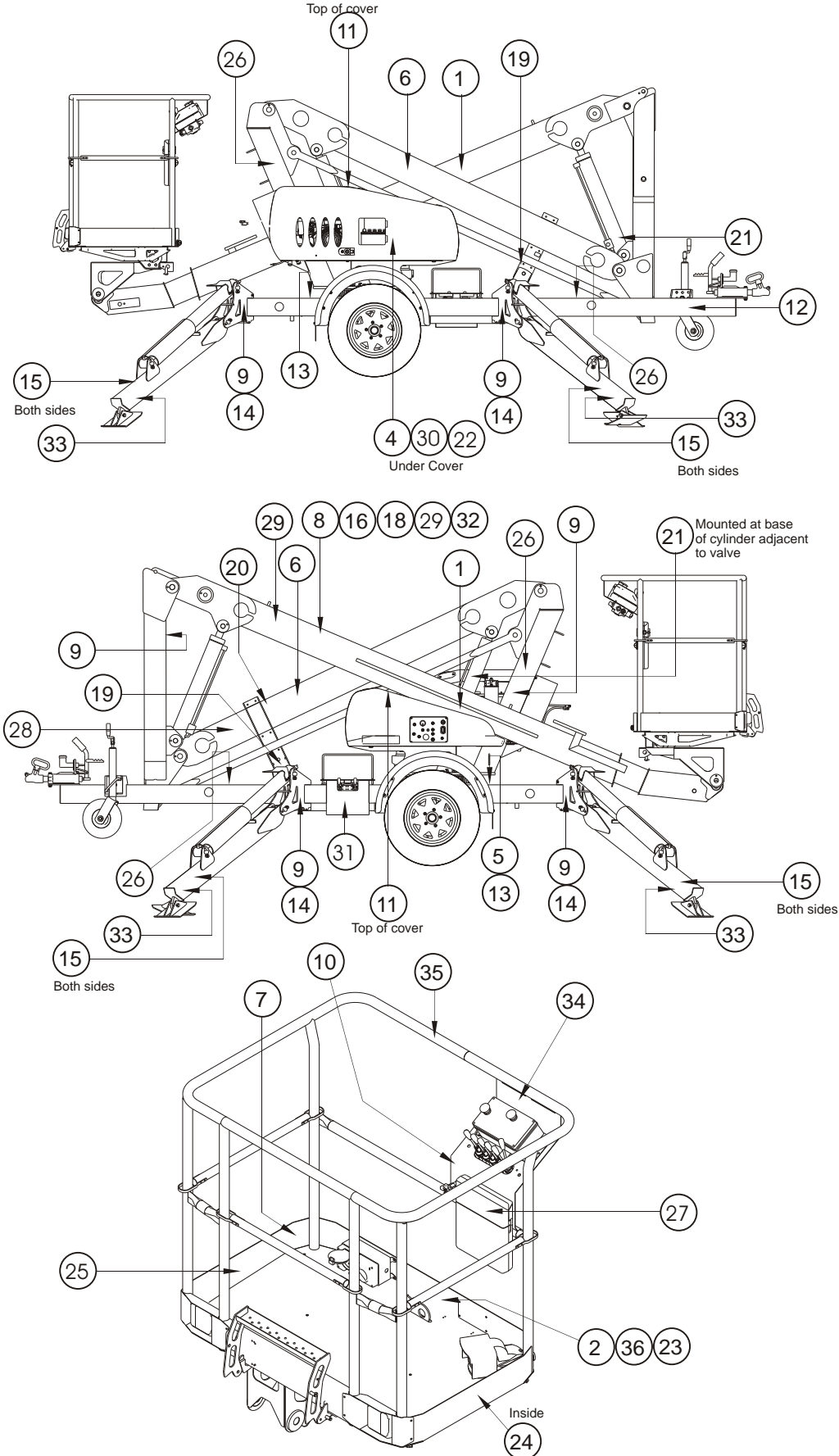

■ Operating Procedures

This chapter explains how to properly start and operate an MHP14AT / MHP13AT. Read and understand all the previous chapters in this manual before you begin to operate an MHP14AT / MHP13AT.

⚠ CAUTION

Do not leave the MHP14AT / MHP13AT engine running if you are sandblasting. Sand drawn into the air intake can erode engine parts.

■ Control Stations

An MHP14AT / MHP13AT can be operated from the ground control box or from the platform control box. There are basically two differences between ground control and platform control operations, both are safety related:

1. The ground control station can override the platform control station at any time. If a person operating the machine from the platform becomes incapacitated, a person on the ground can always take over machine control.
2. The stabilisers can only be selected from the ground control station and only when the booms are in the stowed position.

⚠ DANGER

The MHP14AT / MHP13AT is not Electrically Insulated in its standard form.

Death or Serious Injury to operating personnel, can occur if the machine should come into contact with energized electrical wires during operation.

DO NOT attempt to operate the MHP14AT / MHP13AT ground controls if the platform, booms, or any other conducting part of an MHP14AT / MHP13AT is in contact with energized electrical wires or if there is an immediate danger of such contact.

NOTE

See the "Electrical Hazard" section, in this manual for a complete explanation of the hazards concerning electricity.

■ Emergency Stopping

To stop an MHP14AT / MHP13AT, press the red **EMERGENCY STOP** button in, on either the ground control box or the platform control box

■ Emergency Stopping

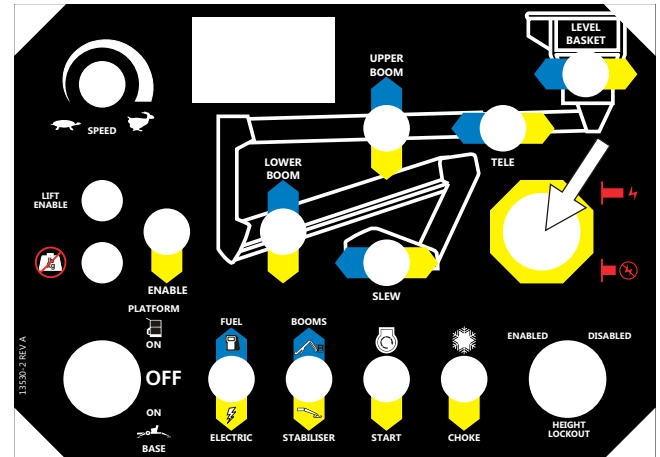

Figure 8.1 - Ground Control Box Emergency Stop Switch Location.

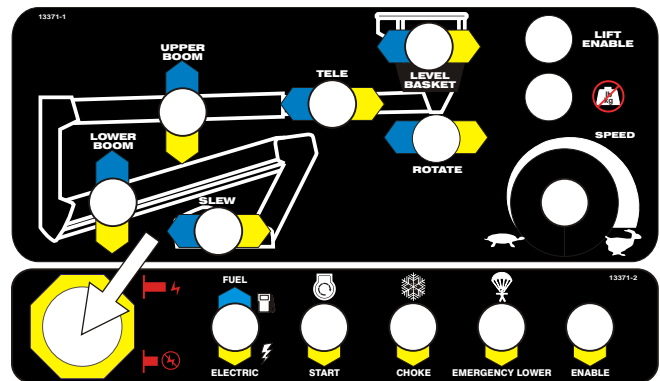

Figure 8.2 - Platform Control Box Emergency Stop Switch Location.

NOTE

For a complete discussion of the **Emergency Stop** switches, see "Controls" chapter 6, and "Emergency Operation" chapter 9 in this manual.

■ Operation Considerations

To use this chapter, first decide whether you will be starting and operating the MHP14AT / MHP13AT from the ground control box or the platform control box.

■ Stabiliser Operation

NOTE: All Stabiliser Operations

The stabilisers will only function when the platform is fully lowered and the booms are stowed. Once the booms are raised the stabilisers will not operate.

Once the platform is raised the stabilisers cannot be set or adjusted.

8. Operation

Before operating the stabilisers check to see that the ground conditions under the four stabiliser pads is firm, stable and unobstructed.

▲ DANGER

If the platform is up and the ground compresses unevenly under different stabiliser pads the MHP might fall over causing serious injury or death. Check the level bubble frequently during operation. If any movement of the bubble occurs, immediately lower the platform and readjust the stabilisers to re-center the bubble in the ring.

When using the stabilisers always check that all four are firmly on the ground and that they are clear of manhole covers, drains, etc., which may collapse. If the ground is at all soft, steel plates at least 300mm x 300mm x 6mm should be placed under the feet to spread the weight.

▲ DANGER

Death or serious injury can result if an MHP tips over. Do not use the stabilisers to gain extra working height, they are not designed for that purpose. At least one of the stabilisers should raise the MHP above the ground - use the other three to level the MHP as necessary.

NOTE: Operating the Stabilisers

Before you can operate the stabilisers you need to start the engine. See "Starting From Ground Control Box" on page 3.

☐ Using the manual stabiliser valves

Ensure the Boom/Stabiliser Switch (item 5 on the ground control box) (see Figure 8.7) is set to stabiliser.

Activate the stabilisers with the valve levers (downwards). (see Figure 8.3)

NOTE:

Ensure that the front stabilisers are lowered first to prevent damage to the jockey wheel.

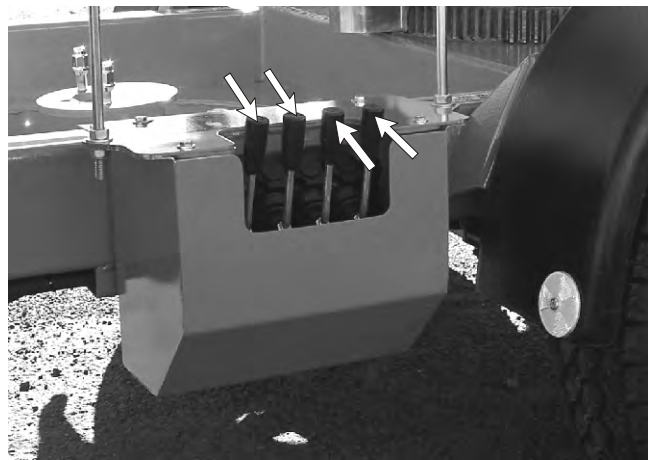

Figure 8.3

Lower the rear stabilisers and level the machine using the level bubble (see Figure 8.4) adjacent to the control levers.

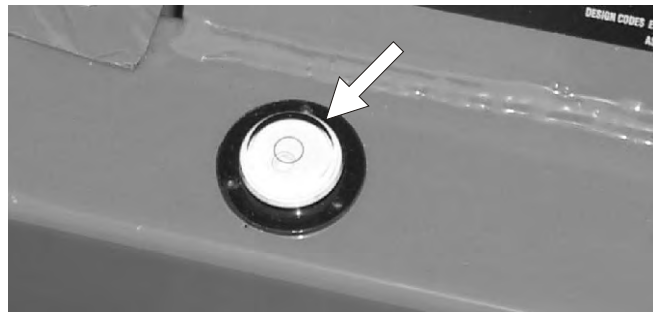

Figure 8.4

▲ WARNING

When levelling the machine in either the manual or automatic mode care is required to ensure that all the foot plates are firmly on the ground, the machine is level and the lift enable light is on before entering the platform.

☐ Raising the manually operated stabilisers

Raising the stabilisers is the reverse of setting the stabilisers.

Ensure that the Boom/Stabiliser Switch is set to stabiliser.

Raise the stabilisers by activating the individual valve levers (upwards).

NOTE:

Ensure that the rear stabilisers are raised first to prevent damage to the jockey wheel.

■ Self levelling stabilisers (Optional)



Figure 8.5 - Auto Level Controls

For units fitted with self levelling stabilisers the following applies:

1. Press and hold down the auto level switch ①

The stabilisers will lower and the machine will "level" automatically.

NOTE:

Switch ① is also used to raise the stabilisers to the stowed position. To do so press and hold switch ① in the auto stow direction and all the stabilisers will raise automatically to the stowed position.

NOTE:

Although this option is primarily designed to automatically set the stabilisers it is also possible to set the stabilisers manually.

□ Setting the stabilisers manually

1. Operate each switch ② (see Figure 8.5) to raise or lower each stabiliser one at a time. Use the level bubble (see Figure 8.4) to check the machine is level.

▲ WARNING

When levelling the machine in either the manual or automatic mode care is required to ensure that all the foot plates are firmly on the ground, the machine is level and the lift enable light is on before entering the platform.

■ Unlocking the boom

The boom lock pin must be removed before operating the booms (see Figure 8.6).

▲ IMPORTANT

Failure to remove the boom lock pin before attempting to raise the booms could result in damage to the machine.

Remove the pin keeper ① and then remove the pin ② from the boom cradle lock ③.

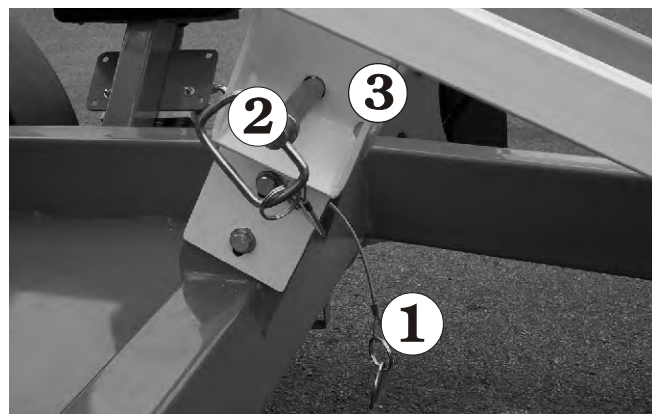

Figure 8.6 - Boom Cradle Lock

■ Starting From Ground Control Box

Before you begin to operate the MHP14AT / MHP13AT from the ground control box, a qualified operator must perform the "Pre-operational Inspection" as described in chapter 7, of this manual.

To start the engine from the ground control box do the following:

1. Set the **Emergency Stop** switch ① to ON (see Figure 8.7).

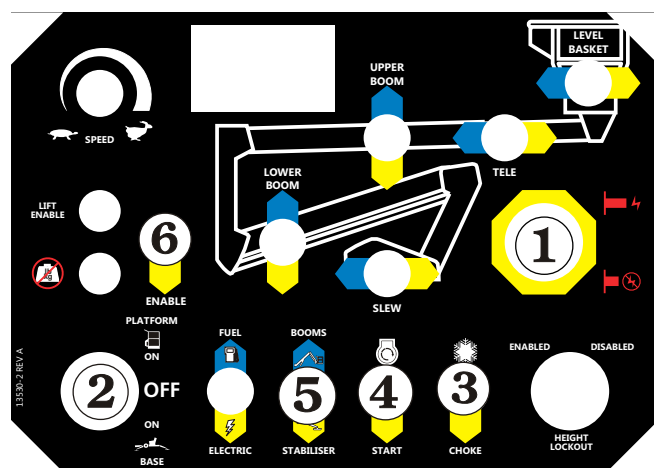

Figure 8.7 - Ground Control Box Starting

2. Insert the key and set the **Platform/Ground Selector** switch ② to GROUND (see Figure 8.7).

8. Operation

- If the engine is at ambient temperature (cold), hold the **Choke / Cold Start Switch** ③ (see Figure 8.7) down throughout the next step.
- Press down on the **Start Switch** and hold it there until the engine starts or for a maximum time of 6 seconds. When the engine starts release the start switch ④ and the choke switch ③, if you used it (see Figure 8.7).

⚠ CAUTION

If the engine does not start in 6 seconds turn the key off and release the choke. Wait 60 seconds before trying to restart the engine again. Continual cranking of the starter motor will only result in its damage.

The engine should now be running, and the stabilisers need to be set before the MHP14AT / MHP13AT is ready to begin work.

■ Starting From Platform Control Box

Before you begin to operate the MHP14AT / MHP13AT from the platform control box, a qualified operator must perform the "Pre-operational Inspection" as described in chapter 7, of this manual.

To start the engine from the platform control box you must first set some switches on the ground control box, including setting the stabilisers and levelling the machine.

(See page 8-2 for information on setting the stabilisers)

- Insert the key ① into the **Platform / Ground Selector Switch** at the ground control box and select platform (see Figure 8.8).

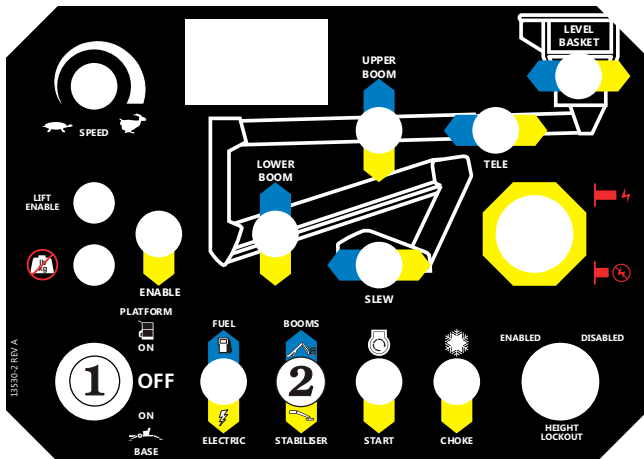

Figure 8.8

- Set the **Booms/Stabiliser Selector** ② to BOOMS

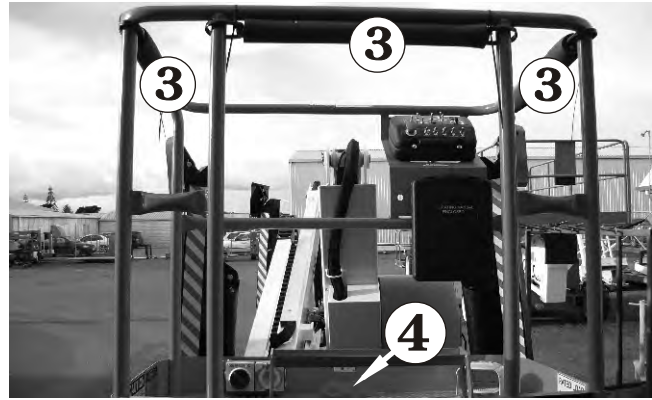

Figure 8.9

- Enter the platform, close the gravity gate ③, and attach the lanyard of your fall restraint (safety harness) to one of the anchor points ④ (see Figure 8.9).

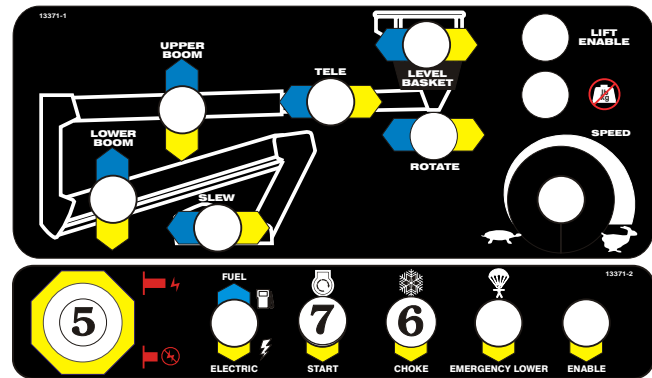

Figure 8.10

- Set the **Emergency Stop** switch ⑤ to (ON) (see Figure 8.10).
- If the engine is at ambient temperature (cold), hold the **Choke Switch** ⑥ (see Figure 8.10) down throughout the next step.
- Press down on the **Start Switch** and hold it there until the engine starts or for a maximum time of 6 seconds. When the engine starts release the start switch ⑦ and the choke switch ⑥, if you used it (see Figure 8.7).

⚠ CAUTION

If the engine does not start in 6 seconds, turn the Anti-Restart switch OFF and release the choke. Wait 60 seconds before trying to restart the engine again. Continual cranking of the starter motor will only result in its damage.

The engine should now be running, and the MHP14AT / MHP13AT is ready to begin work.

■ Moving The Platform

The engine should already be running (as described earlier in this chapter), before you start this section.

⚠ DANGER

DO NOT operate near energized electrical conductors. Maintain the (M.S.A.D.), Minimum Safe Approach Distance to energized power lines. See the "Electrical Hazard" section, in this manual for a complete explanation of the hazards concerning electricity. Maintain the clearances shown on the decal attached to the platform.

⚠ WARNING

Be certain that the space into which you are about to move the platform, boom, turntable, and/or chassis is free of obstructions. ALWAYS look in the direction of movement.

⚠ WARNING

When you operate from the platform control box, be sure that the lanyard of your fall restraint is attached to an anchor point on the platform mount. Also, be sure that platform gate is closed behind you.

□ From ground control box

Each of the platform movement switches is shown in the following photograph.

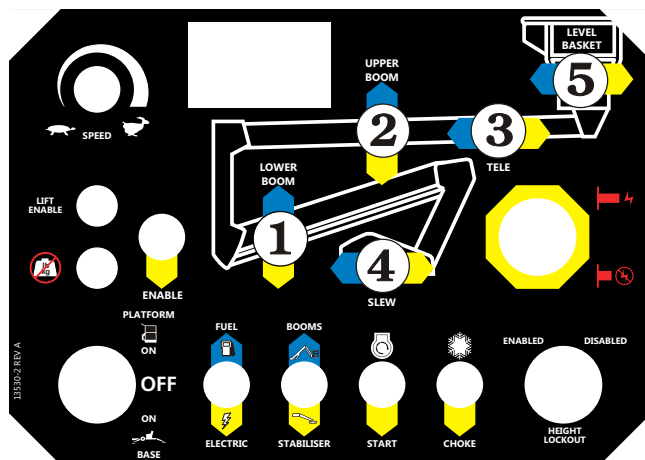

Figure 8.11 - Movement Control, Ground Control Box

These platform moving switches, (1 through 5), will produce the following movement.

1. **Lower boom switch:** Moving this switch up will raise the lower boom, whilst pressing it down will cause the lower boom to descend.
2. **Upper boom switch:** Moving this switch up will raise the upper boom, whilst pressing it down will cause the upper boom to descend.
3. **Tele boom switch:** Moving this switch right causes the telescopic boom to extend whilst moving it to the left causes the telescopic boom to retract.
4. **Slew switch:** Pressing this switch to the right causes the column/boom/platform assembly to rotate to the right, whilst pressing the switch to the left causes the column/boom/platform assembly to rotate to the left.
5. **Platform level switch:** Pressing the switch to the left causes the platform to tilt forward whilst moving the switch to the right causes the platform to tilt backwards.

⚠ IMPORTANT

You must operate the enable control, in conjunction with the platform moving switches.

This is a safety feature to prevent the platform from moving if a platform moving switch, or controller, is accidentally pushed.

8. Operation

□ From platform control box

▲ WARNING

When you operate from the platform control box, be sure that the lanyard of your fall restraint is attached to an anchor point on the platform mount.

Each of the platform movement switches is shown in the following photograph.

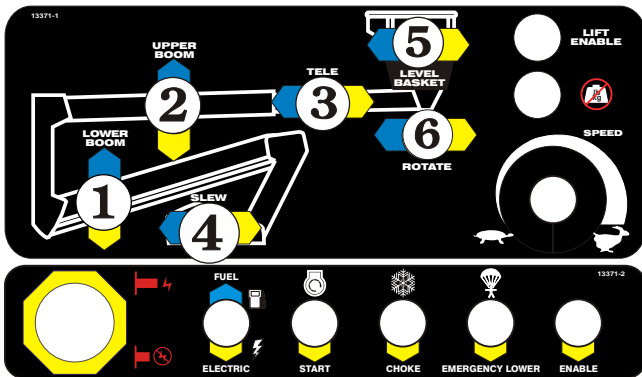

Figure 8.12 - Movement Control, Platform Control Box

▲ IMPORTANT

You must operate the enable control, in conjunction with the platform moving switches.

This is a safety feature to prevent the platform from moving if a platform moving switch, or controller, is accidentally pushed.

These platform moving switches, (1 through 5), will produce the following movement.

1. **Lower boom switch:** Moving this switch up will raise the lower boom, whilst pressing it down will cause the lower boom to descend.
2. **Upper boom switch:** Moving this switch up will raise the upper boom, whilst pressing it down will cause the upper boom to descend.
3. **Tele boom switch:** Moving this switch to the right causes the telescopic boom to extend, whilst moving it to the left causes the telescopic boom to retract.
4. **Slew switch:** Pressing this switch to the left causes the column/boom/platform assembly to rotate to the right, whilst pressing the switch to the right causes the column/boom/platform assembly to rotate to the left.

5. **Platform level switch:** Pressing the switch to the left causes the platform to tilt forward whilst moving the switch to the right causes the platform to tilt backwards.

6. **Platform rotate switch (Option):** Pressing the switch (when fitted), to the left rotates the platform to the left. Pressing the switch to the right rotates the platform to the right.

■ Securing for Day

At the end of each work day the MHP14AT / MHP13AT should be returned to the STOWED POSITION and locked as described under "Stowing" in the "Stowing and Transporting" chapter 10.

■ Emergency Operation Procedures

The following procedures are emergency procedures only. **DO NOT** use them for normal operation. Their purpose is to get the platform and operator safely to ground when the MHP14AT / MHP13AT will not start or some other problem keeps the platform from lowering in the normal way.

■ Emergency Operation Procedures

□ Operation from platform control box

⇒ Ground control station settings

Switch settings listed in the three steps below must exist at the ground before emergency operation procedures will work at the platform control box:

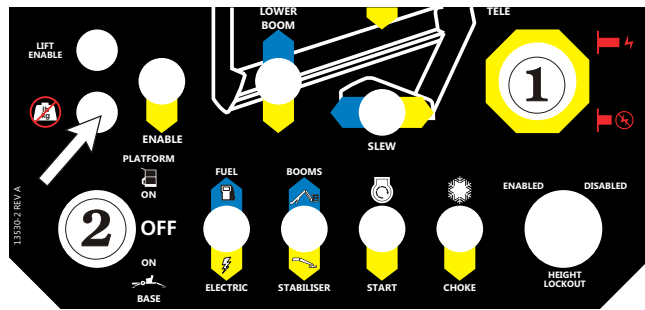

Figure 9.1 - Ground Control Box

1. The **Emergency Stop** switch ① must be ON (Out) (see Figure 9.1).
2. The **Platform/Ground Selector** switch ② (see Figure 9.1) must be set to PLATFORM.

⇒ Platform control station

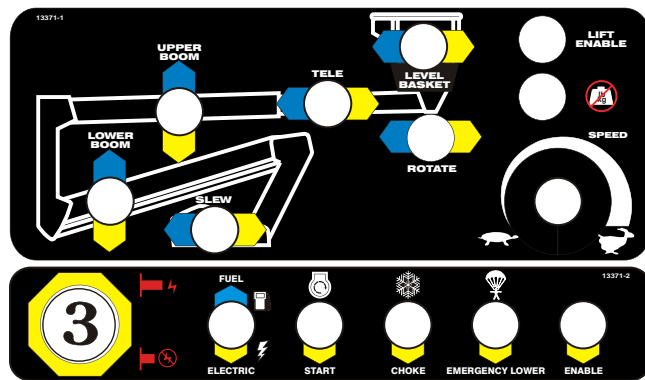

Figure 9.2 - Platform Control Box

3. Set the **Emergency Stop** switch ③ to ON (see Figure 9.2).

▲ IMPORTANT

The MHP14AT / MHP13AT has an **ENABLE** switch fitted to the Upper & Lower control boxes. (see Chapter 6 for a full explanation of the operation of this switch).

Some machines will also be fitted with a **FOOT OPERATED ENABLE** switch.

On those machines fitted with the foot switch option, both the switch on the control box and the foot switch perform the same function.

However it is assumed that for units fitted with a foot switch this will be the preferred method of operation.

If the **FOOT OPERATED ENABLE SWITCH** option is installed on your machine go to Step 4 - otherwise go to Step 5.

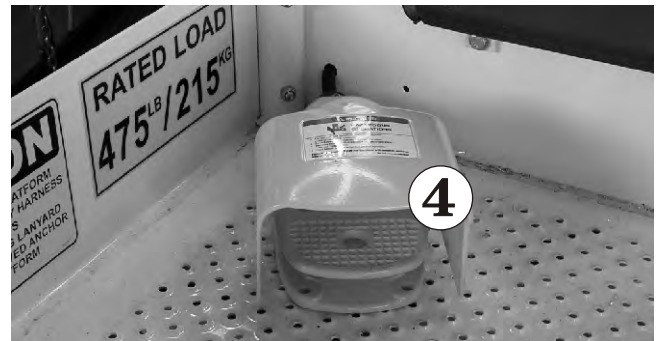

Figure 9.3 - Foot Switch Option

4. Step on the **Platform Foot** switch ④ (see Figure 9.3).

Go to Step 6.

5. Operate the **Enable** switch ⑤ by pressing the switch down and hold it down (see Figure 9.4).

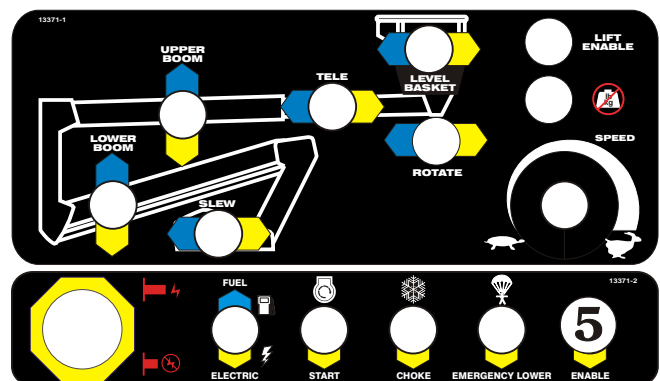

Figure 9.4 - Enable Switch

9. Emergency Operation

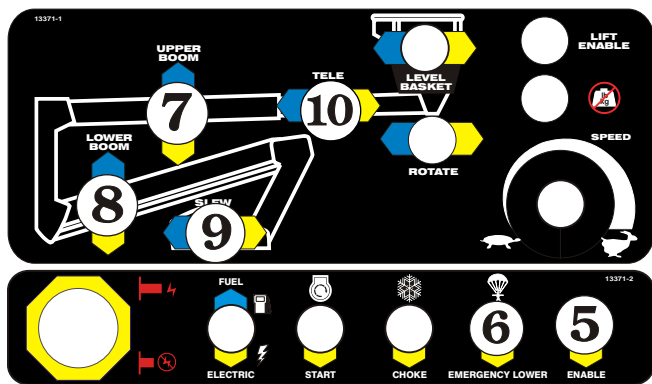

Figure 9.5 - Platform Control Box

6. Whilst still operating the enable switch, press and hold the **Emergency Lower** switch **6** down (see Figure 9.5) and the booms will begin lowering.
7. To **SLEW** during the emergency lower the following switches (see Figure 9.5) must be operated together.

Enable 5 or 4 (foot switch - Figure 9.3)
Emergency Lower 6
Upper or Lower Boom Up 7 or 8
Slew 9

8. To **TELE** during emergency lower the following switches (see Figure 9.5) must be operated together.

Enable 5 or 4 (foot switch - Figure 9.3)
Emergency Lower 6
Upper or Lower Boom Up 7 or 8
Tele 10

Both booms will descend at the same time when lowering.

▲ IMPORTANT

Slewing and or telescoping the boom in must be completed before the booms are fully lowered.

- Operation from ground control position

▲ CAUTION

When performing this function, extreme care must be taken to ensure that the person carrying out the task does not become trapped by the structure as the booms descend.

▲ DANGER

DO NOT, under any circumstances, climb down the elevating assembly to operate these valves.

There are two manual bleed down valves to operate from the ground position.

One controls the descent of the lower boom and the other controls the descent of the upper boom.

The lower boom must be lowered first

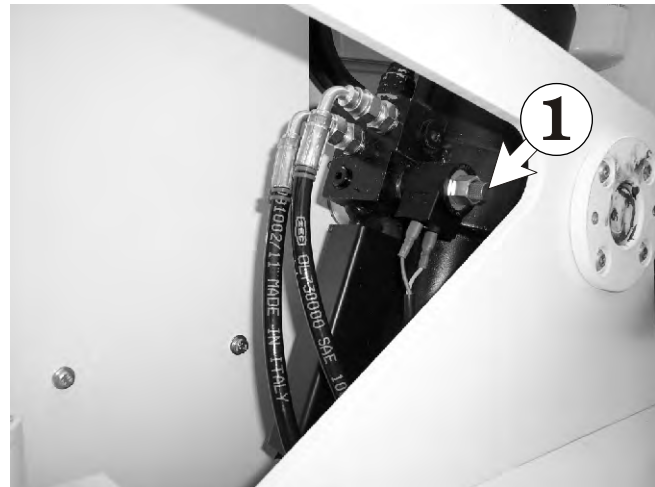

Figure 9.6.1 - Manual Lower Valve, Lower Boom

1. Open manual valve **1** to lower the lower boom (see Figure 9.6.1). This valve is located at the base of the main lift cylinder.

To operate this valve push in the red knurled knob and turn it anti-clockwise 180 degrees and release it. The lower boom will begin to descend.

When the lower boom has fully descended you can open the valve for the upper boom (see Figure 9.6.2).

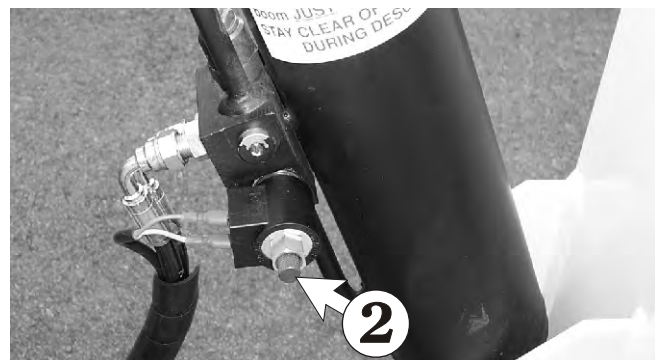

Figure 9.6.2 - Manual Lower Valve, Upper Boom

2. Open the manual valve to lower the upper boom. This valve is located at the base of the main lift cylinder for the upper boom in the floating turret.

Operation of this valve is the same as for the previously described lower boom. The upper boom will begin to descend.

NOTE

It is not possible to slew or telescope in during emergency lowering from the ground control station.



Figure 9.7 - Manual Lowering Procedure Decal

▲ IMPORTANT

At the completion of this operation the manual emergency bleed down valves for the upper and lower booms must be reset (closed). This is achieved by pushing each valve in and turning it clockwise 180° and then releasing it.

Failure to do this will prevent normal operation of the booms and platform.

■ Stowing

At the end of each work day (or in preparation for lifting or storage) a qualified operator should put the MHP14AT / MHP13AT into its stowed position then lock by placing the boom lock pin in position.

- ❑ The correct stowed position is shown here.



Figure 10.1 - Stowed Position

To bring the MHP14AT / MHP13AT into the STOWED POSITION use the controls on the ground control box or platform control box to:

1. Fully lower all booms.
2. Align the boom travel lock with the boom rest **1** mounted to the drawbar (see Figure 10.2).

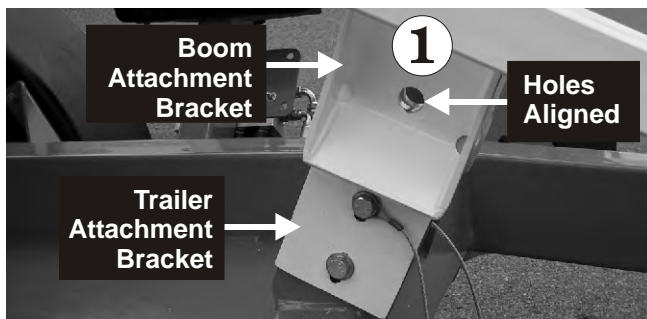

Figure 10.2 - Locking the Booms

3. Insert the boom pin **2** in place (see Figure 10.3) and ensure the pin keeper **3** is correctly locked in place through the boom pin.

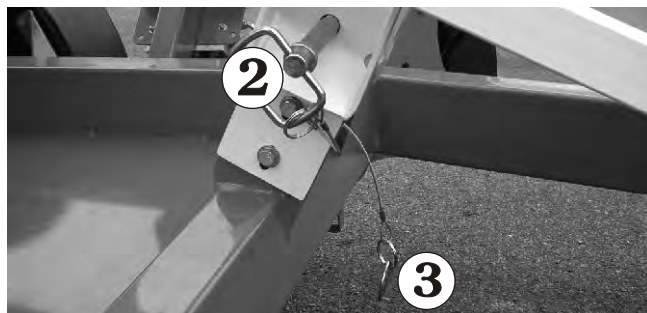

Figure 10.3 - Boom Lock Pin

■ Transporting

❑ Trailering

When moving the MHP14AT / MHP13AT on a transport trailer the following points must be adhered to.

▲ DANGER

1. The unit must be in the stowed position.
2. The boom lock **MUST** be in place.
3. Care must be taken when loading the unit onto the trailer that it does not run away. Chock the wheels and apply the handbrake.
4. The MHP14AT / MHP13AT can be loaded by forklift.

❑ Securing to a Transport Vehicle

5. Tie down only with the 4 tie down lugs (see Figure 10.4).



Figure 10.4 - Tie Down Lugs

NOTE:

The tie down lugs are located at each corner of the trailer, two at the front and two at the rear.

▲ IMPORTANT

DO NOT

- Tie down over the draw bar.
- Tie down over the booms or level rods.
- Tie down over the platform.

Reverse the above procedure after transporting.

10. Stowing and Transporting

■ Towing

The correct size tow ball MUST be used when connecting the draw bar to the towing vehicle. The coupling is stamped with the correct size. Be aware of local transport regulations.

1. Visually inspect the tow ball on the towing vehicle.
2. Ensure the tow ball is matching in size with the tow coupling on the trailer.
3. Ensure the tow ball is mounted correctly and is fitted tightly.
4. Connect the tow coupling and ensure the latching mechanism is working and has latched.
5. Connect the break-away chain to the towing vehicle, unset the reversing lock on the tow coupling.
6. Check that the bolt, D-Clamp or attaching device is able to take the rated load.
7. Connect the trailer road lights to the towing vehicle and test that the functions work.
8. Retract the jockey wheel and place it in the stowed position (see photograph below).

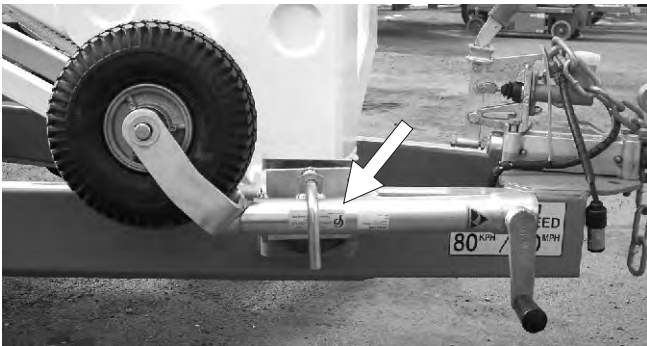

9. Check no debris or work tools are in the platform.

▲ DANGER

Death or Serious Injury can result from losing control of a trailer when towing.

Never tow above the rated speed marked on the draw bar.

Never tow the unit with an under rated vehicle. Always check manufacturers vehicle load specifications.

▲ DANGER

The Boom Restraint MUST be in place whilst the trailer is being towed.

■ Bi-Energy, Petrol/Diesel / 24V DC

There are various Bi-Energy options available for the MHP14AT / MHP13AT. The following describes the Petrol/Diesel / 24V option.

This consists of a combination of both a gasoline or diesel engine and a 24V DC motor to give a Bi-energy option.

Specifically a 24V DC motor is mounted on the column under the left hand side cover. This provides an alternative power source to the gasoline or diesel engine.

The DC motor is powered by four "Deep Cycle Traction Batteries" mounted 2 each side of the column and an automatic battery charger that is also mounted on the column.

□ DC motor

The DC motor is mounted under the left hand side cover (see Figure 11.1).



Figure 11.1 - DC Motor

□ DC motor operation

A Fuel / Electric switch is used to select either the gasoline/diesel engine or the DC motor. This switch is mounted on the front of the lower control box (see Figure 11.2.1).



Figure 11.2.1 - Fuel / Electric Switch

If the gasoline/diesel engine is selected [SWITCH UP] the DC motor will not function and if the DC motor is selected [SWITCH DOWN] the gasoline/diesel engine will not run.

□ DC motor battery switch

In order to operate the DC motor the 24V DC battery isolator switch, mounted at the centre rear of the column, will also need to be switched on (see Figure 11.3).

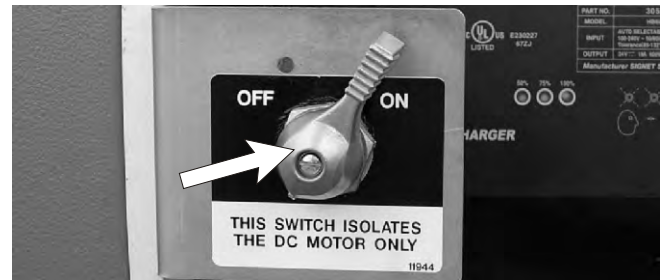

Figure 11.3 - DC Motor Battery Isolate Switch

Note - 24V DC Battery Switch

When operating the gasoline/diesel engine the 24V DC battery switch should be turned to the "off" position.

□ Setting the manual stabilisers

In order for the stabilisers to function an additional switch (see Figure 11.4) needs to be operated.

This switch, mounted adjacent to the stabiliser valve levers, must be held on in the STABILISER ENABLED ① position while the individual stabiliser valves are operated.

When released it will automatically return to the STABILISER DISABLED ② position

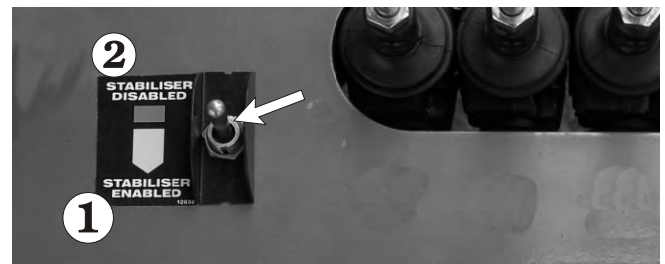

Figure 11.4 - Stabiliser Enable Switch

Note: - Stabiliser Enable Switch

*This switch is **ONLY** fitted to units that have manual stabiliser valve levers.*

□ Setting the automatic stabilisers

When the Automatic Stabiliser Option is fitted there is no need to use the stabiliser enable switch described above.

For automatic stabiliser operation refer to the Operation Chapter.

11. Options

❑ Operation

Once the DC mode is selected the motor will then power all the functions in the normal manner, (excluding the manual stabiliser operation described above).

The only difference is that the DC motor will only run when a function is selected e.g. raising a boom.

❑ Batteries

Since the Bi-Energy MHP is powered by "Deep Cycle Traction Batteries" particular attention should be paid to the batteries on-board charger to ensure proper operation.

The batteries are mounted at each side of the column (see Figures 11.5 and 11.6).



Figure 11.5 - Two DC Motor Batteries (Lower Control Box Side)



Figure 11.6 - Two DC Motor Batteries (Petrol/Diesel Engine Side)

▲ IMPORTANT

The side covers must be removed/raised whilst charging to allow gasses to escape.

▲ DANGER

Lead-acid batteries contain sulphuric acid which will damage eyes or skin on contact.

When working around batteries, ALWAYS wear a face shield to avoid acid in the eyes.

If acid contacts eyes, flush immediately with clear water and get medical attention.

Wear rubber gloves and protective clothing to keep acid off the skin, if acid contacts the skin, wash off immediately with clear water.

Lead-acid batteries produce flammable and explosive gasses. NEVER allow smoking, flames or sparks around batteries.

❑ Battery charger

The Bi-energy MHP is fitted with an on-board charger (see Figure 11.7). The charger will completely re-charge the batteries and automatically turn off after the cycle is completed.



Figure 11.7 - On-Board Battery Charger

The battery charger is fitted with an "interlock". This means that during the charging cycle all functions on the machine are inoperative and will remain so until the charger unit is switched off.

The charging cycle may last from 1 to 12 hours depending on the state of the batteries.

If the charging cycle should exceed 16 hours (indicating a fault) the charger will automatically shut down and the batteries should be checked.

The inlet for connection of mains power to the charger is mounted under the left hand side cover and can be accessed with the side cover removed (see Figure 11.8).



Figure 11.8 - Mains Power Connector For Charger

▲ IMPORTANT

DO NOT recharge the batteries unless the electrolyte level has been checked.

▲ DANGER

DO NOT allow smoking, flames or sparks around batteries.

▲ IMPORTANT

DO ENSURE the side covers are removed/raised during the charging process to allow gasses to escape.

☐ Batteries - general maintenance

Always keep the batteries clean, free of dirt and corrosion. A film on top of the battery can accelerate discharge.

Cold reduces battery capacity and retards charging. Heat increases water usage and can (in extreme circumstances) result in overcharging.

Use distilled water to refill the batteries. Avoid water containing metallic solids such as iron.

☐ Batteries - charging

Fully recharge the batteries, immediately after use. One charging cycle per day is preferred. Fully charged batteries perform best. The deeper the discharge, the fewer number of cycles a battery will deliver. Deep discharges deteriorate the battery quicker than shallow cycles.

An overly discharged battery may need to be cycled a few times before it can fully recover. If a battery begins to heat before becoming fully charged, it may be necessary to recharge and discharge the battery a few times.

The MHP is equipped with an automatic battery charger that will completely recharge the batteries and turn off after the charge cycle is completed.

■ Bi-Energy, Petrol/Diesel / 240V AC

Another Bi-Energy option available for the MHP14AT / MHP13AT is the 240V AC / Petrol/Diesel option described below.

This consists of a combination of both a gasoline or diesel engine and a 240V AC motor to give a Bi-energy option.

Specifically a 240V AC motor is mounted on the column under the left hand side cover. This provides an alternative power source to the gasoline or diesel engine.

The AC motor is powered from an external AC power source

☐ AC motor

The AC motor is mounted under the left hand side cover (see Figure 11.9).



Figure 11.9 - AC Motor

☐ AC motor operation

A Gas/Electric switch is used to select either the petrol/diesel engine or the AC motor (see Figure 11.10).

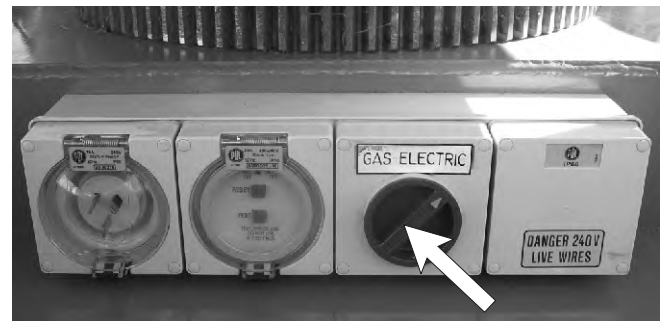

Figure 11.10 - Petrol/Electric Switch

11. Options

❑ AC power connection

In order for the AC motor to operate (when the petrol/electric switch is in the electric position) an AC power source must be connected to the MHP (see Figure 11.11).



Figure 11.11 - AC Power Input Connector

❑ Operation

The same controls are used to stop, start and operate the electric motor as are used for the petrol/diesel motor.

If the petrol/electric switch is in "electric mode" but no AC power source is connected the MHP will default to petrol operation when the ignition switch is activated.

❑ Bi-Energy, Hydraulic Oil Tank

For both Bi-Energy options described an additional feed line from the hydraulic oil tank is used (see Figure 11.12).

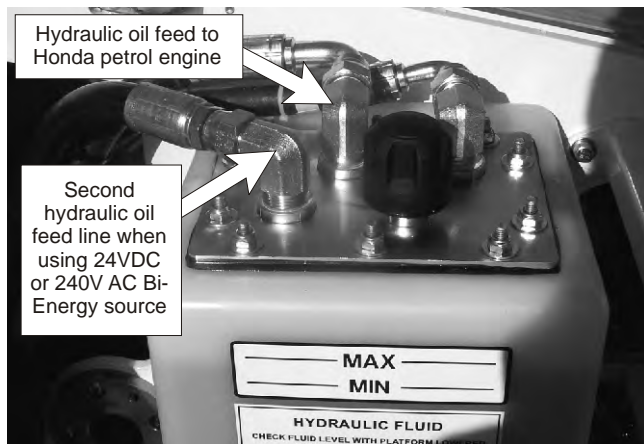

Figure 11.12 - Bi-Energy Hydraulic Tank

■ Other Options

■ Air Line To Platform

This consists of pressure flex yellow hose rated at 150 psi working pressure, fitted with quick disconnect couplers at each end.

■ Work Lights

Rubber encased work lights can be fitted to the platform guardrails. The lights are swivel mounted and each has its own switch.

■ Flashing Light

Mounted on the lower boom the flashing light alerts people that the MHP14AT / MHP13AT is moving. The light flashes at about one flash per second any time the MASTER KEY switch is on. There is no ON/OFF switch for the flashing light, it cannot be turned off while the MHP15/44 is running.

An option is also available that does allow ON/OFF switching of the flashing light.

■ Battery Isolate Switch

Isolates the battery power and can be locked into the off position.

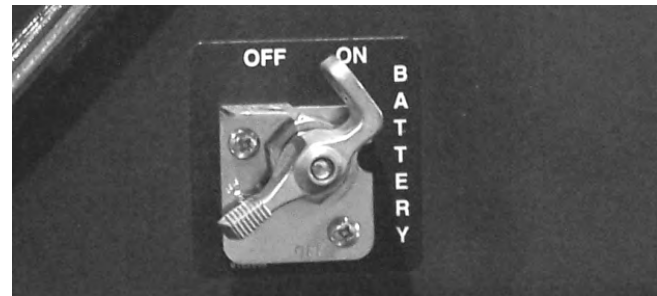

Figure 11.13 - Battery Isolate Switch

■ Alternative Power Options

There are a variety of alternative power options available for the MHP14AT / MHP13AT. These consist of:

Diesel engine, 24V power, 240V power and 110V power.

■ RCD/ELCB AC Outlet

A 3 core wire rated at 600 volts AC 15 amps is run up the booms as standard.

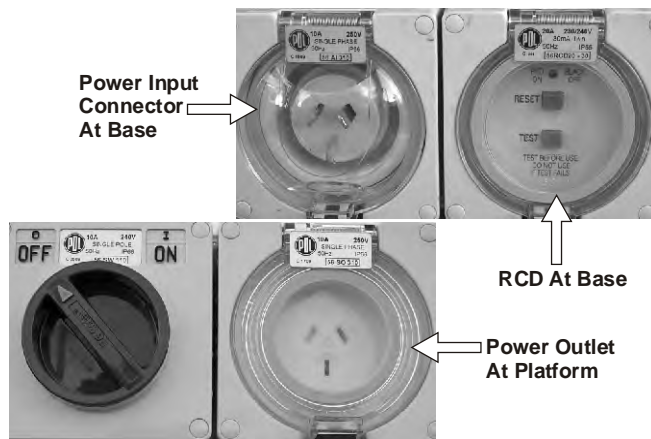

Figure 11.14 AC Outlet

■ Self Levelling Stabiliser

With this option the stabilisers will ‘self level’ the platform when the auto mode is selected, alternatively the stabilisers can be used individually when in the manual mode.

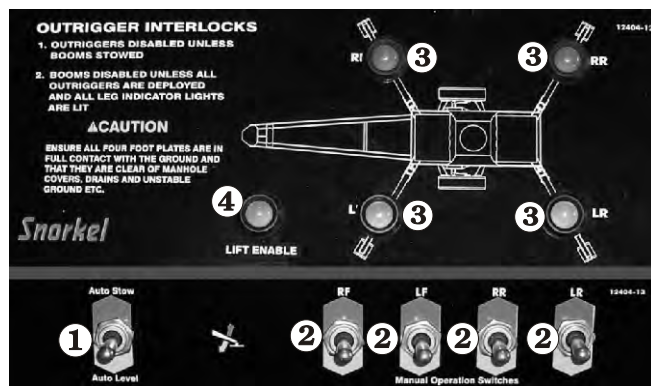

Figure 11.15 - Self Levelling Stabilisers

■ Spare Wheel

Mounted on the front of the trailer in a recessed well, this is an ideal option for machines that regularly travel in isolated country areas.



Figure 11.16 - Spare Wheel

■ Platform Foot Switch

The foot switch performs the same function as the standard enable switch. Stepping on the foot switch is an action that must be performed, at the same time as another action, to make the booms/platform move.

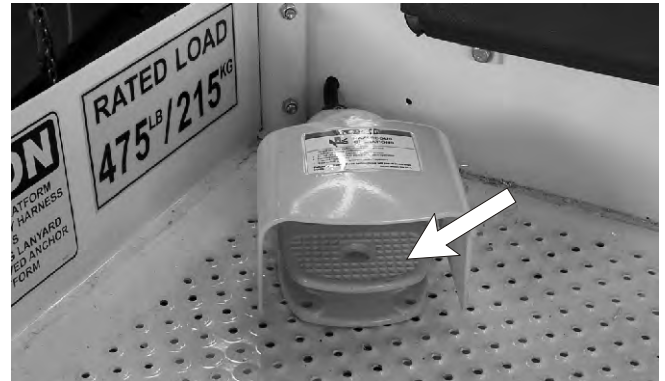

Figure 11.17 - Platform Foot Switch

■ Platform Rotator

Pushing the switch to the left will rotate the platform to the left whilst pushing the switch to the right will rotate the platform to the right.

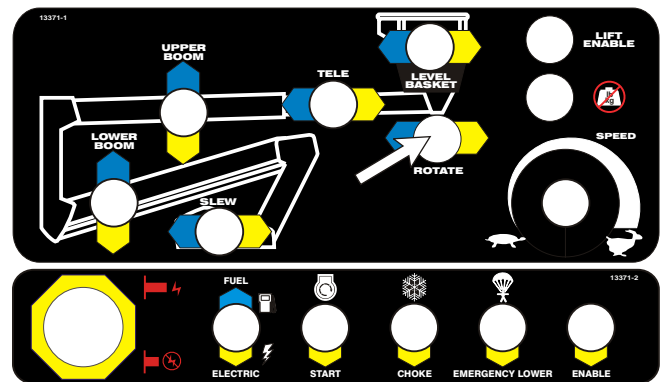

Figure 11.18 - Platform Rotator Switch

11. Options

■ 10.9 Metre Height Restriction Kit

This kit may be fitted to machines **manufactured for the Australian market** to comply with Australian legislation.

For machines fitted with this kit a key switch **1** is provided on the lower control box.

This switch allows the machine to operate to its full boom height of 11.5m when the switch is in the **DISABLED** position **3** or to the restricted height of 10.9m when the switch is in the **ENABLED** position **2** see Figure 11.19.

The key switch is fitted in the upper left hand corner of the lower control box.

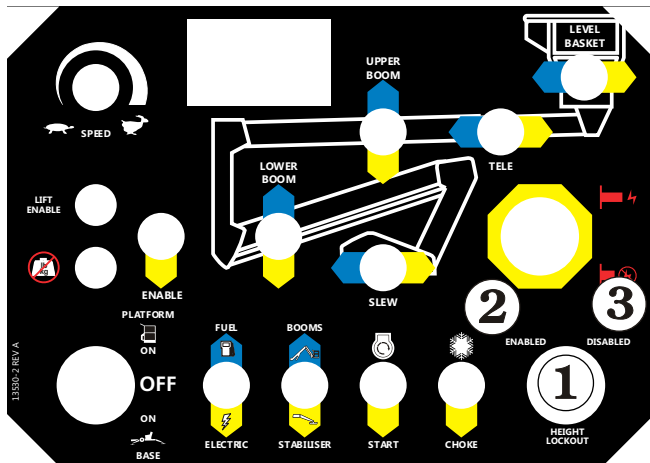

Figure 11.19 - Height Lockout Switch

The use of the machine in the unrestricted mode (over 10.9m) by an uncertified operator is a breach of Australian law.

In order to operate this machine in the unrestricted mode the operator is **required to hold a WP certificate of Competency.**

▲ IMPORTANT

The key **MUST NOT** be left in the machine by a qualified operator when the machine is left unattended.

Note:

The key can only be removed in the 10.9m restricted mode thus ensuring that it is not able to be operated at full height by an unqualified operator.

■ Hazardous Components

Snorkel products may contain materials and objects that potentially could become significant fire or environmental hazards during the lifetime of the machine.

1. Antifreeze (ethylene glycol)
2. Battery, lead/acid
3. Diesel fuel
4. Foam in tires
5. Gasoline
6. Hydraulic oil
7. Liquefied petroleum gas
8. Motor oil

The rest of this chapter lists manufacturers' information you will need if you ever have to control any of the above items during an upset or emergency.

☐ Antifreeze (UN 1993)

☞ Fire extinguishing media:

Dry Chemical, foam, or CO₂.

☞ Special fire fighting procedures:

Water spray may be ineffective on fire but can protect fire fighters and cool closed containers. Use fog nozzles if water is used.

▲ DANGER

DO NOT enter confined fire space without full bunker gear. (Helmet with face shield, bunker coats, gloves & rubber boots). Use a NIOSH approved positive pressure self contained breathing apparatus. Keep container tightly closed. Isolate from oxidizers, heat and open flame.

☞ Spill or leak:

Small - mop up with absorbent material and transfer to hood.

☞ Waste disposal method:

Small - evaporate until all vapors are gone. Dispose of remainder by legally applicable methods.

☐ Battery, Lead/Acid (UN 2794)

☞ Extinguishing media:

Dry chemical, foam, or CO₂.

☞ Special fire fighting procedures:

Use positive pressure, self contained breathing apparatus.

☞ Unusual fire and explosion hazards:

Hydrogen and oxygen gases are produced in the cells during normal battery operation.

▲ DANGER

Hydrogen gas is flammable and oxygen supports combustion. These gases enter the air through the vent caps. To avoid the chance of a fire or explosion, keep sparks and other sources of ignition away from the battery.

☞ Spill or leak:

Remove combustible materials and all sources of ignition. Contain spill by diking with soda ash (sodium carbonate) or quicklime (calcium oxide). Cover spill with either chemical. Mix well. Make certain mixture is neutral then collect residue and place in a drum or other suitable container. Dispose of as hazardous waste.

▲ DANGER

ALWAYS wear acid resistant boots, face shield, chemical splash goggles, and acid resistant gloves when handling acid spills or leaks.

NOTE

DO NOT release UN-neutralized acid!

☞ Waste disposal method:

Sulfuric Acid: Neutralize as above for a spill, collect residue, and place in a drum or suitable container. Dispose of as hazardous waste.

NOTE

DO NOT flush lead contaminated acid to sewer.

☞ Waste disposal method

Batteries: Send to lead smelter for reclamation following applicable federal, state, and local regulations.

☐ Diesel Fuel (NA 1993)

☞ Extinguishing media:

Use water spray, dry chemical, foam, or CO₂.

12. Fire Fighting and Chemical Control

☞ Special fire fighting procedures:

Use water to keep fire exposed containers cool. If leak or spill has not ignited, use water spray to disperse the vapors and to provide protection for personnel attempting to stop a leak. Water spray may be used to flush spills away from exposures.

☞ Unusual fire and explosion hazards:

Products of combustion may contain carbon monoxide, carbon dioxide, and other toxic materials.

▲ DANGER

DO NOT enter enclosed or confined space without proper protective equipment including respiratory protection.

☞ Spill or leak:

Contain spill immediately in smallest area possible. Recover as much of the product itself as possible by such methods as vacuuming, followed by soaking up of residual fluids by use of absorbent materials.

Remove contaminated items including contaminated soil and place in proper containers for disposal. Avoid washing, draining, or directing material to storm or sanitary sewers .

☞ Waste disposal method:

Recycle as much of the recoverable product as possible.

Dispose of non-recyclable material as a RCRA hazardous waste by such methods as incineration, complying with federal, state, and local regulations.

☐ Foam In Tires

☞ Extinguishing media:

Water, dry chemical, foam, or CO₂.

☞ Special fire fighting procedures:

Evacuate non emergency personnel to a safe area.

☞ Unusual fire and explosion hazards:

Fire fighters should use self contained breathing apparatus. Avoid breathing smoke, fumes, and decomposition products.

Use water spray to drench smoldering elastomer. Product may melt, after ignition, to form flammable liquid.

▲ DANGER

Burning produces intense heat, dense smoke, and toxic gases, such as carbon monoxide, oxides of nitrogen, and traces of hydrogen cyanide.

☞ Spill or leak:

Pick up and handle as any other inert solid material.

☞ Waste disposal method:

Not considered a hazardous material. Dispose of material according to any local, state, and federal regulations.

☐ Gasoline (UN 1203)

☞ Extinguishing media:

Dry chemical, foam, or CO₂.

☞ Special fire fighting procedures:

Water may be ineffective to extinguish, but water should be used to keep fire exposed containers cool. If a leak or spill has not ignited, use water spray to disperse the vapors and to protect personnel attempting to stop a leak. Water spray may be used to flush spills away from areas of potential ignition.

☞ Unusual fire and explosion hazards:

Highly Flammable. Products of combustion may contain carbon monoxide, carbon dioxide and other toxic materials.

▲ DANGER

DO NOT enter enclosed or confined space without proper protective equipment including respiratory protection.

☞ Spill or leak:

Review fire and explosion hazards before proceeding with clean up. Use appropriate personal protective equipment during clean up. Dike spill. Prevent liquid from entering sewers, waterways, or low areas. Soak up with sawdust, sand, oil dry or other absorbent material. Shovel or sweep up.

Remove source of heat, sparks, flame, impact, friction or electricity including internal combustion engines and power tools. If equipment is used for spill cleanup, it must be explosion proof and suitable for flammable liquid and vapor.

NOTE

Vapors released from the spill may create an explosive atmosphere.

☞ Waste disposal method:

Treatment, storage, transportation and disposal must be in accordance with applicable federal, state, provincial, and local regulations.

▲ CAUTION

DO NOT flush to surface water or sanitary sewer system. By itself, the liquid is expected to be a RCRA ignitable hazardous waste.

☐ Hydraulic Oil (UN 1270)

☞ Extinguishing media:

Use water spray, dry chemical, foam, or CO₂.

☞ Special fire fighting procedures:

Water or foam may cause frothing. Use water to keep fire exposed containers cool. Water spray may be used to flush spills away from exposures.

☞ Unusual fire and explosion hazards:

Products of combustion may contain carbon monoxide, carbon dioxide, and other toxic materials.

▲ DANGER

DO NOT enter enclosed or confined space without proper protective equipment including respiratory protection.

☞ Spill or leak:

Contain spill immediately in smallest area possible. Recover as much of the product itself as possible by such methods as vacuuming, followed by soaking up of residual fluids by use of absorbent materials.

Remove contaminated items including contaminated soil and place in proper containers for disposal. Avoid washing, draining or directing material to storm or sanitary sewers .

☞ Waste disposal method:

Recycle as much of the recoverable product as possible.

Dispose of non-recyclable material as a RCRA hazardous waste by such methods as incineration, complying with federal, state, and local regulations.

☐ Liquefied Petroleum Gas (UN 1075)

☞ Extinguishing media:

Water spray. Class A-B-C or BC fire extinguishers.

☞ Special fire fighting procedures:

Stop flow of gas. Use water to keep fire exposed containers cool. Use water spray to disperse unignited gas or vapor.

If ignition has occurred and no water available, tank metal may weaken from over heating. Evacuate area. If gas has not ignited, LP gas liquid or vapor may be dispersed by water spray or flooding.

☞ Unusual fire and explosion hazards:

Highly Flammable. Products of combustion may contain carbon monoxide, carbon dioxide and other toxic materials.

▲ DANGER

DO NOT enter enclosed or confined space without proper protective equipment including respiratory protection.

☞ Spill or leak:

Keep public away. Shut off supply of gas. Eliminate sources of ignition. Ventilate the area. Disperse with water spray.

Contact between skin and these gases in liquid form can cause freezing of tissue causing injury similar to thermal burn.

NOTE

Vapors released from the spill may create an explosive atmosphere.

☞ Waste disposal method:

Treatment, storage, transportation and disposal must be in accordance with applicable federal, state, provincial, and local regulations.

☐ Motor Oil (UN 1270)

☞ Extinguishing media:

Use water spray, dry chemical, foam, or CO₂.

12. Fire Fighting and Chemical Control

Special fire fighting procedures:

Water or foam may cause frothing. Use water to keep fire exposed containers cool. Water spray may be used to flush spills away from exposures.

Unusual fire and explosion hazards:

Products of combustion may contain carbon monoxide, carbon dioxide, and other toxic materials.

⚠ DANGER

DO NOT enter enclosed or confined space without proper protective equipment including respiratory protection.

Spill or leak:

Contain spill immediately in smallest area possible. Recover as much of the product itself as possible by such methods as vacuuming, followed by soaking up of residual fluids by use of absorbent materials.

Remove contaminated items including contaminated soil and place in proper containers for disposal. Avoid washing, draining or directing material to storm or sanitary sewers .

Waste disposal method:

Recycle as much of the recoverable product as possible.

Dispose of non-recyclable material as a RCRA hazardous waste by such methods as incineration, complying with federal, state, and local regulations.

■ Troubleshooting

All of the actions described in this chapter may be performed by an MHP14AT / MHP13AT operator, a trained and qualified service technician is not required.

The first column, of the following chart, lists some common problems encountered by MHP14AT / MHP13AT operators.

The second column lists some of the causes for

□ Operator Troubleshooting Chart

▲ CAUTION

Any problem that cannot be fixed by actions listed below should be referred to a trained and qualified MHP14AT / MHP13AT service technician.

Problem	Cause	Remedy
Engine will not crank.	1. Flat battery.	Replace / charge battery.
	2. Main circuit breaker, in ground control box, has tripped..	Reset circuit breaker , then try to start the engine. If it will not start, refer the problem to a qualified service technician.
	3. Loose battery terminals .	Tighten battery leads at battery.
Engine cranks but will not start.	1. Out of fuel.	Fill the engine with the correct type / grade of fuel.
	2. Fuel tap off.	Locate fuel tap on engine and turn to ON.
Engine runs but no outrigger function.	1. Leg / boom switch in lower control box incorrectly set	Switch to Stabilisers to operate stabilisers.
Engine runs but no boom function.	1. Speed control set too SLOW.	Turn Speed Control C.W. until function starts.
	2. Stabilisers not set correctly.	All stabilisers must be set on firm ground before boom functions will operate.
	3. Lack of hydraulic oil.	A. Check hydraulic system for leaks. B. Top up the oil tank with the correct type / grade of hydraulic oil.
Bleed down at platform inoperative.	1. Flat battery.	A. Charge / replace the battery. B. Use Manual Bleed Down from lower station.

each problem. The third column lists remedies.

▶ **aerial platform**

a mobile device that has an adjustable position platform, supported from ground level by a structure.

▶ **ambient temperature**

the air temperature of the immediate environment.

▶ **ammeter**

an instrument for measuring the strength of an electric current in amperes.

▶ **authorized personnel**

personnel approved as assigned to perform specific duties at a specific location.

▶ **base**

the relevant contact points of the aerial platform that form the stability support (e.g. wheels, casters, outriggers, stabilisers).

▶ **boom**

a movable cantilever beam which supports the platform.

▶ **center of gravity**

the point in the aerial platform around which its weight is evenly balanced.

▶ **chassis**

the integral part of the aerial platform that provides mobility and support for the booms.

▶ **fall restraint**

a system that is used while working on a boom lift within the boundaries of platform guardrails to provide restraint from being projected upward from the platform. This system includes a harness or belt, lanyard, and a lanyard anchor. Federal OSHA, ANSI, and Snorkel require the use of additional fall protection beyond the platform guardrails on boom supported aerial platforms.

▶ **fall or ground pressure**

the maximum pressure, expressed in pounds per square inch, a single wheel concentrates on the floor or ground.

▶ **gradeability**

the maximum slope that the aerial platform is capable of travel.

▶ **ground fault circuit interrupter or residual current detector**

a fast-acting circuit breaker that opens to stop electrical circuit flow if it senses a very small current leakage to ground. Also called GFCI or RCD. The GFCI/RCD is used to protect personnel against a potential shock hazard from defective electrical tools or wiring.

▶ **guardrail system**

a vertical barrier around the platform to prevent personnel from falling.

▶ **hazardous location**

any location that contains, or has the potential to contain, an explosive or flammable atmosphere as defined by ANSI/NFPA 505.

▶ **jib boom**

a boom assembly located between the main boom and the platform.

▶ **level sensor**

a device that detects a preset degree of variation from perfect level. The level sensor is used to sound an alarm if operating on a slope greater than the preset value. It may also (depending on the machine) prevent the it from operating further until it is brought back within the preset parameters.

▶ **lower controls**

the controls located at ground level for operating some or all of the functions of the aerial platform.

▶ **main boom**

a boom assembly located between the turntable and the platform or jib boom. The main boom includes the base, intermediate, and tip boom.

▶ **maximum travel height**

the maximum platform height or the most adverse configuration(s) with respect to stability in which travel is permitted by the manufacturer.

▶ **Minimum Safe Approach Distance**

the minimum safe distance that electrical conductors may be approached when using the aerial platform. Also called MST

▶ **operation**

the performance of any aerial platform functions within the scope of its specifications and in accordance with the manufacturers instructions, the users work rules, and all applicable governmental regulations.

▶ **operator**

a qualified person who controls the movement of an aerial platform.

▶ **personal fall arrest system**

a fall protection system that is used while working on an unprotected edge (such as a roof top with no guardrail). This system includes a harness, lanyard or other connecting device, a fall arrestor, an energy absorber or decelerator, an anchorage connector, and a secure anchorage such as a building beam, girders or columns. An aerial platform is not a fall arrest anchorage.

▶ **platform**

the portion of an aerial platform intended to be occupied by personnel with their tools and materials.

▶ **platform height**

the vertical distance measured from the floor of the platform to the surface upon which the chassis is being supported.

▶ **prestart inspection**

a required safety inspection routine that is performed daily before operating the aerial platform.

▶ **qualified person**

a person, who by reason of knowledge, experience, or training is familiar with the operation to be performed and the hazards involved.

▶ **rated work load**

the designed carrying capacity of the aerial platform as specified by the manufacturer.

▶ **stow**

to place a component, such as the platform, in its rest position.

▶ **turning radius**

the radius of the circle created by the wheel during a 360° turn with the steering wheels turned to maximum. inside turning radius is the wheel closest to the centre and outside turning radius is the wheel farthest from the centre.

▶ **turntable**

the structure above the rotation bearing which supports the main boom. The turntable rotates about the centerline of rotation.

▶ **unrestricted rated work load**

the maximum designed carrying capacity of the aerial platform allowed by the manufacturer in all operating configurations.

▶ **upper controls**

the controls located on or beside the platform used for operating some or all of the functions of the aerial platform.

▶ **wheelbase**

the distance from the centre of the rear wheel to the centre of the front wheel.

▶ **working envelope**

the area defined by the horizontal and vertical limits of boom travel that the platform may be positioned in.

I

- 10.9 metre restriction kit, 1-5
- 10.9m height restriction kit, 2-2

A

- AC outlet RCD/ELCB, 7-7
- Automatic Shut-offs
 - Stabilisers, 5-1
- Automatic Stabilisers, 8-3
 - Setting Manually, 8-3

B

- Battery fluid level, 7-3
- Battery terminals, 7-3
- Bolts and fasteners, 7-4
- Booms Identification, 3-5

C

- Controls
 - Control switches
 - Boom Speed, 6-2, 6-4
 - Booms/Stabiliser Selector, 8-4
 - Choke/Cold Start, 6-2, 6-4, 8-4
 - Emergency Lower, 6-4
 - Emergency Stop, 6-2, 6-3
 - Emergency Stop switch, 8-3, 8-4, 9-1
 - Enable Foot (option), 6-4
 - Enable switch, 6-4
 - Height Lockout, 6-3
 - Level Basket, 6-2, 6-4
 - Lift Enable, 6-3
 - Lift enable indicator, 6-4
 - Lower Boom, 6-2, 6-4, 8-5, 8-6
 - Master Key Switch, 7-1
 - Platform Level, 8-5, 8-6
 - Platform/Ground Selector, 6-2, 8-3, 9-1
 - Slew, 6-2, 6-4, 8-5, 8-6
 - Stabiliser / Boom Selector Switch, 6-2
 - Start, 6-4
 - Tele Boom, 6-2, 6-4, 8-5, 8-6
 - Upper Boom, 6-2, 6-4, 8-5, 8-6
 - Emergency Lower, 6-3
 - Ground Control Box, 6-2
 - Control switches, 6-2
 - Platform Control Box
 - Control switches, 6-3
 - Platform Rotator, 8-6
- Controls and Control Decals Locations, 6-1

E

- Electrical
 - Electrocution, 1-3, 8-1
- Electrical Hazard Warning
 - see Electrical Hazard - page i
- Emergency lower, 7-6
- Emergency Lower Control, 6-3
- Emergency Lowering From Ground
 - Manual Valve Lower Boom, 9-2
 - Manual Valve Upper Boom, 9-2
- Emergency Operation, 9-1
 - Operation From Ground Control Box, 9-2
 - Operation From Platform Control Box, 9-1
 - Procedures, 9-1
- Engine
 - Cooling system, 3-3
 - Displacement, 3-3
 - Engine oil level, 7-2
 - Fuel, 3-3
 - Fuel consumption, 3-3
 - Fuel grade, 3-3
 - Fuel leaks, 7-2
 - Fuel Level, 7-2
 - Fuel tank cap, 7-2
 - Ignition system, 3-3
 - Make, 3-3
 - Model, 3-3
 - Oil capacity, 3-3
 - Oil grade, 3-3
 - Type, 3-3
- Engine data, 3-3

F

- Falling hazards, 1-3
- Flashing light, 7-6

G

- Gauges
 - Hourmeter, 4-1
 - Hydraulic Oil Level, 4-1
 - Level Bubble, 4-1
- General Specifications, 3-1
- Ground Control Box, 6-2
- Ground Control Switches, 7-6
- Ground station, 7-6

Index

H

Hazardous Components, 12-1
 Battery, Lead/Acid (UN 2794), 12-1
 Gasoline (UN 1203), 12-2
 Hydraulic Oil (UN 1270), 12-3
 Motor Oil (UN 1270) , 12-3
Hourmeter, 4-1
Hydraulic oil
 Filler cap, 7-3
Hydraulic oil leaks, 7-3
Hydraulic oil level, 7-3
Hydraulic Oil Level, 4-1

I

Inspection
 Operators pre-operational inspection, 7-1
 Inspection and Maintenance Table, 7-1
Insulation rating, 3-1, 3-2

L

Left side view of machine, 3-6
Level Bubble, 4-1
Light Flashing, 7-6

M

manual of responsibilities, A-iv
Manual Stabiliser Valves, 8-2
Maximum height to basket floor, 3-1, 3-2
Maximum outreach, 3-1, 3-2
Maximum rated axle capacity, 3-1, 3-2
Maximum towing speed, 3-1, 3-2
Minimum Safe Approach Distance
 see Electrical Hazard - page ii

N

Nomenclature And Serial Numbers, 3-5

O

Operating Procedures, 8-1
 Control Stations, 8-1
 Emergency Stopping, 8-1
 Moving The Platform, 8-5
 Starting From Ground Control Box, 8-1
 Starting From Platform Control Box, 8-4
Operation, 8-1
Operators
 Qualified, 7-1, 8-3
Operator's Manual, 7-2
Other Safety Devices, 2-1
Overall height, 3-1, 3-2

P

Placards and decals, 7-7
 Standard placards and decals, 7-7
Platform
 Lanyard anchor points, 7-5
Platform Control Switches, 7-7
Platform Gravity Gate, 7-5
Platform Guardrails, 7-5
Platform size, 3-1, 3-2
Pre-operational Inspection Table, 7-1
Pre-start Inspection, 1-2

R

RCD/ELCB Outlet (option), 5-1
Right side view of machine, 3-5

S

Safe Operation, 1-1
Safe working load, 3-1, 3-2
safety alerts, A-iii
Safety Decals and Placards, 1-5
Safety Devices
 Bubble level, 2-3
 Emergency Stop Switches, 2-1
 Enable switch, 2-2
 Enable switch (foot), 2-3
 Flashing light, 2-4
 Gravity gate, 2-2
 Guardrails, 2-2
 Lanyard anchor points, 2-1
 RCD/ELCB AC outlet, 2-3
 Safety Device Information, 2-1
Safety precautions
 Fuel Handling Precautions, 1-4
 Hydraulic Systems, 1-4
Securing for Day, 8-6
Stabiliser Controls, 6-5
 Automatic Operation, 6-5
 Manual Operation, 6-5
Stabilisers, 5-1
Stowing
 Correct Stowed Position, 10-1
 Locking the Booms, 10-1
Stowing the MHP14AT, 10-1
 Boom lock pin, 10-1
 Boom Restraint and Keeper, 10-1
Structural damage and welds, 7-5
 Boom welds, 7-5

T

- Tipover hazard, 1-3
- Towing, 10-2
 - Bolt, D-Clamp or attaching device, 10-2
 - Jockey wheel, 10-2
 - Latching mechanism, 10-2
 - Road lights, 10-2
 - Tow ball, 10-2
- Trailer tongue weight, 3-1, 3-2
- Transporting the MHP14AT, 10-1
 - Securing to a Transport Vehicle, 10-1
 - Trailing, 10-1
- Travelling height, 3-1, 3-2
- Troubleshooting, 13-1
 - Operator Troubleshooting Chart, 13-1
- Turntable rotation, 3-1, 3-2
- Tyre Pressure, 7-4

U

- Unlocking the Booms, 8-3

W

- Warranty - Limited
 - see inside front cover
- Weight, 3-1, 3-2
- Wheels and tyres, 7-4
- Wiring harnesses, 7-2
 - Loose connections, 7-2
- Work Place Inspection and Practices, 1-2
- Working Envelope MHP14AT, 3-4
- Working height, 3-1, 3-2

Local Distributor / Lokaler Vertiebs Händler / Distributeur local
El Distribuidor local / Il Distributore locale

**EUROPE, MIDDLE EAST
AFRICA & ASIA**

PHONE: +44 (0) 845 1550 057
FAX: +44 (0) 845 1557 756

NORTH & SOUTH AMERICA

PHONE: +1 785 989 3000
TOLL FREE: +1 800 255 0317
FAX: +1 785 989 3070

AUSTRALIA

PHONE: +64 2 9725 4000
FAX: +64 2 9609 3057

NEW ZEALAND

PHONE: +64 6 3689 168
FAX: +64 6 3689 164

 **snorkel**
www.snorkellifts.com